



KONGSBERG

TARGET SYSTEMS



Target Definitions

21.05.2024

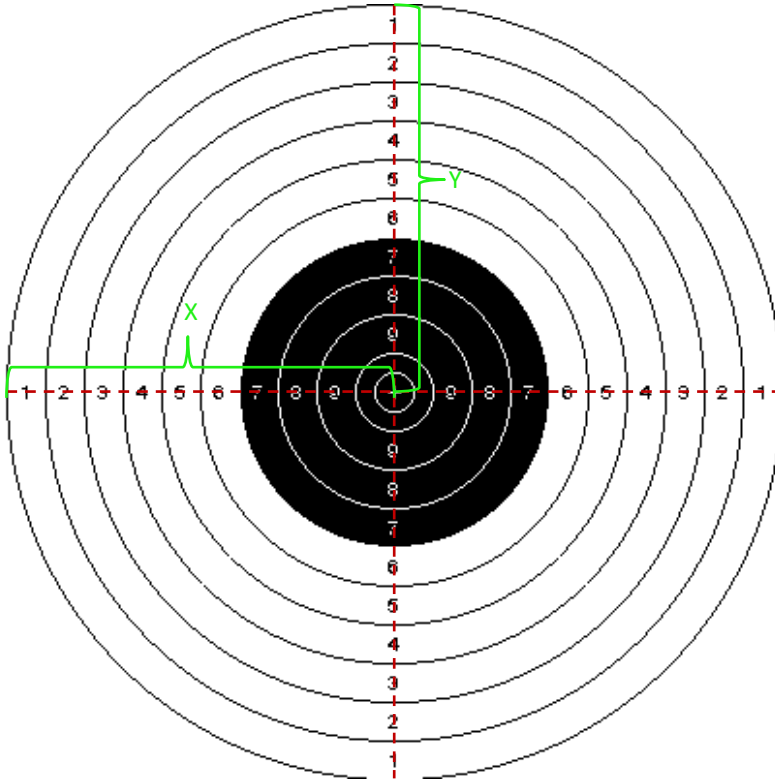

Diameter (mm)	Value
30	*
60	X
120	9
180	8
240	7
300	6
360	5
420	4
480	3
540	2
600	1

X	300 mm
Y	300 mm

Zoom levels

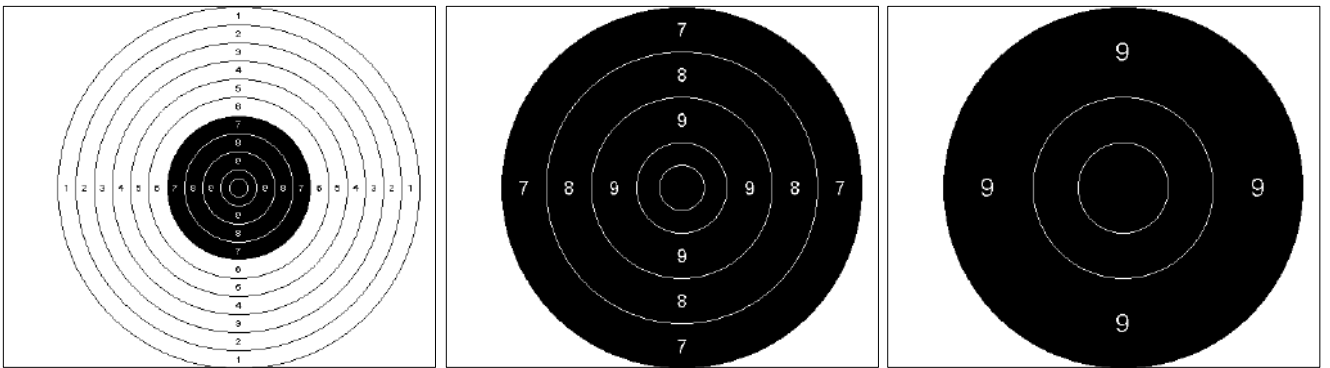

Technical data

Part No	735-0097-97-0001
Size	N/A
Gauge (default)	8 mm
Aiming mark diameter	240 mm
Manufacture	
Manufacture Part No	

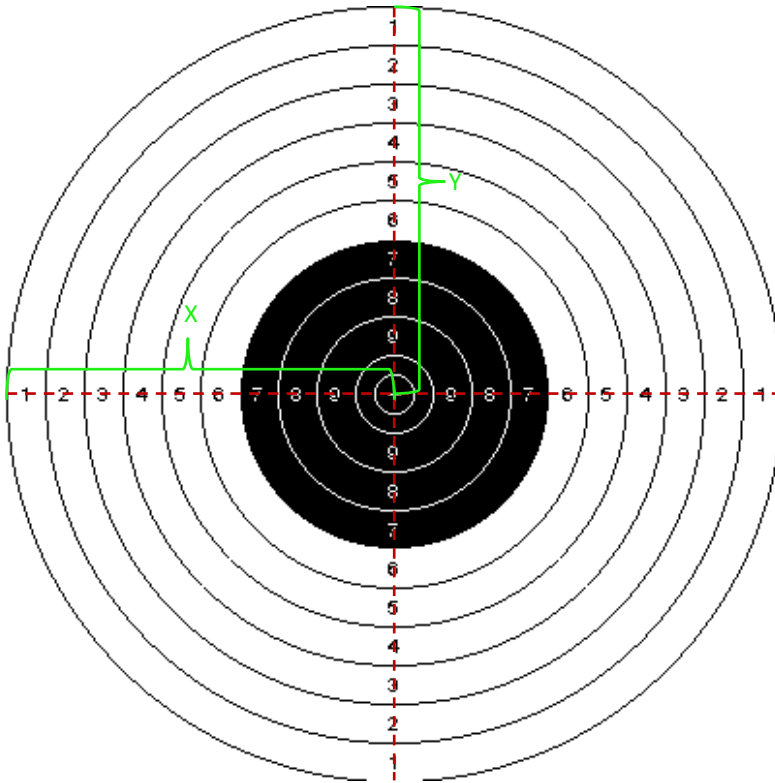

Diameter (mm)	Value
50	*
100	X
200	9
300	8
400	7
500	6
600	5
700	4
800	3
900	2
1000	1

X	500 mm
Y	500 mm

Zoom levels

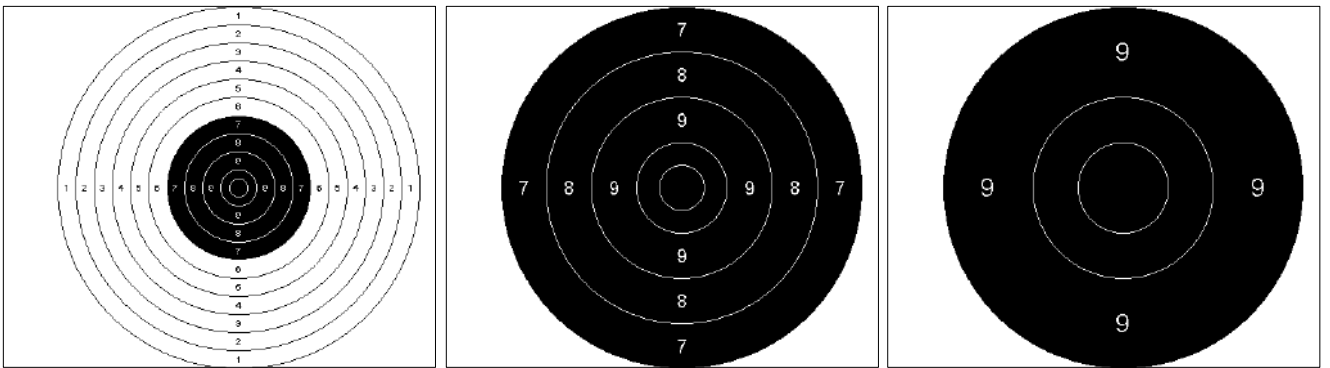

Technical data

Part No	735-0097-97-0002
Size	N/A
Gauge (default)	8 mm
Aiming mark diameter	400 mm
Manufacture	
Manufacture Part No	

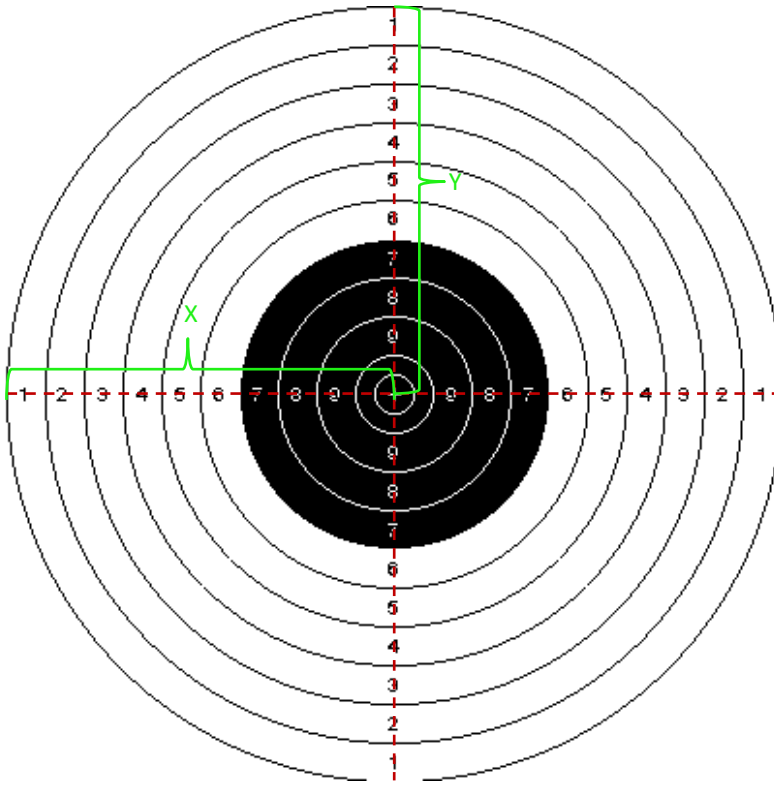

Diameter (mm)	Value
75	*
150	X
300	9
450	8
600	7
750	6
900	5
1100	4
1200	3
1350	2
1500	1

X	750 mm
Y	750 mm

Zoom levels

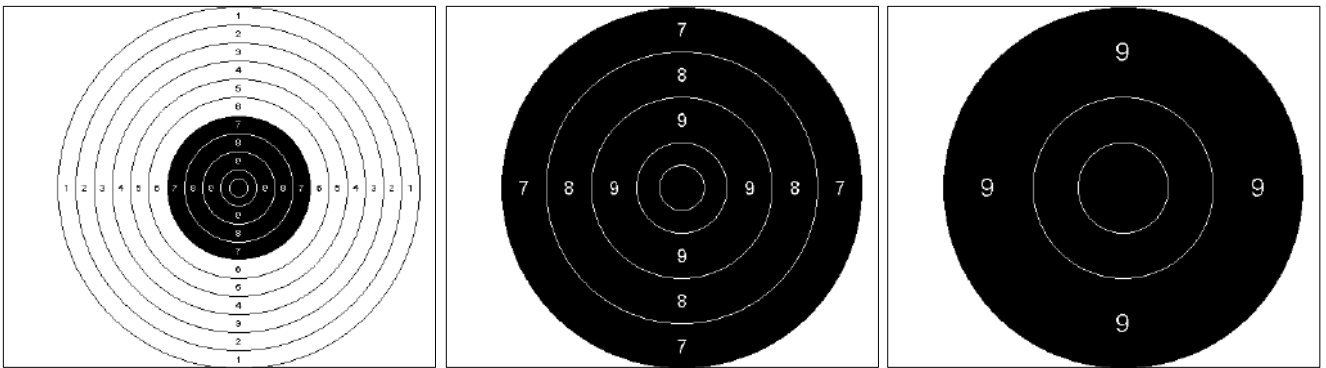

Technical data

Part No	735-0097-97-0003
Size	N/A
Gauge (default)	8 mm
Aiming mark diameter	600 mm
Manufacture	
Manufacture Part No	

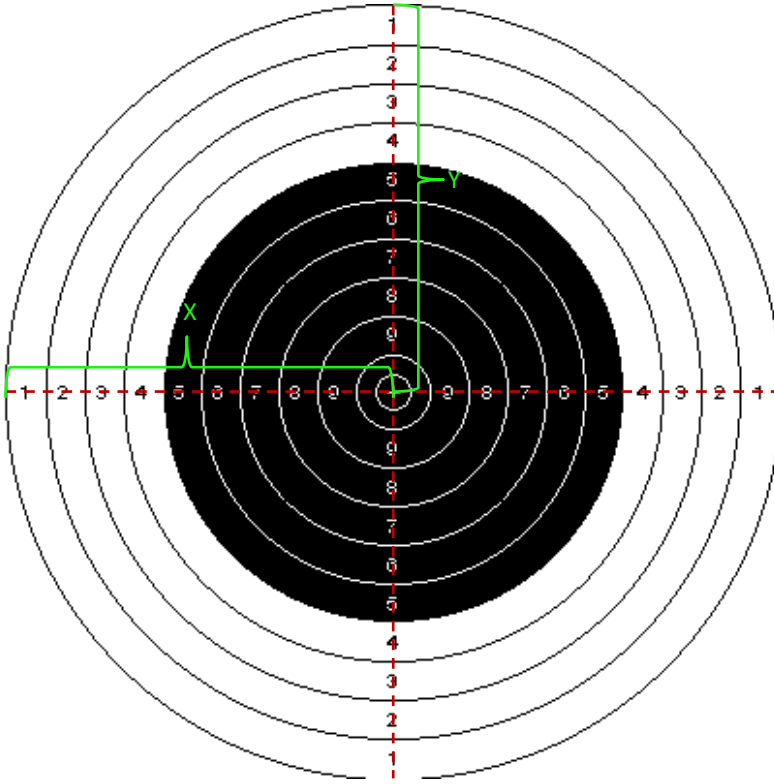

Diameter (mm)	Value
30,67	*
64,00	X
130,67	9
197,33	8
264,00	7
330,67	6
397,33	5
464,00	4
530,67	3
597,33	2
664,00	1

X	332 mm
Y	332 mm

Zoom levels

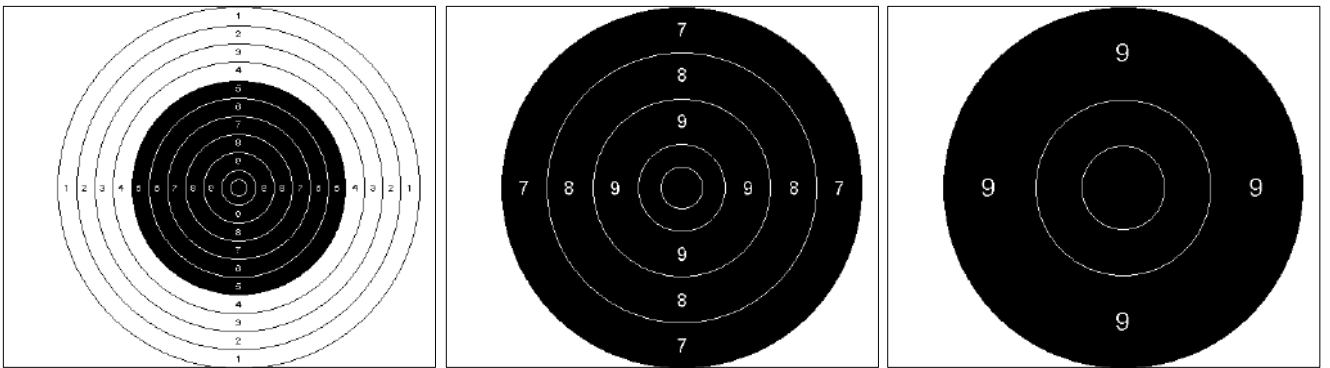

Technical data

Part No	735-0097-97-0004
Size	N/A
Gauge (default)	8 mm
Aiming mark diameter	400 mm
Manufacture	
Manufacture Part No	

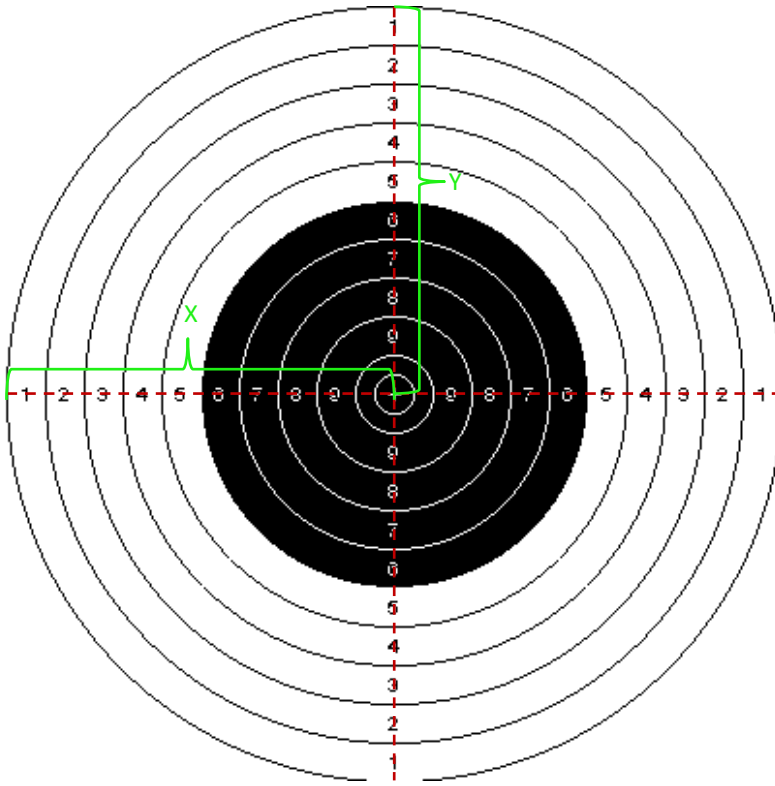

Diameter (mm)	Value
50	*
100	X
200	9
300	8
400	7
500	6
600	5
700	4
800	3
900	2
1000	1

X	500 mm
Y	500 mm

Zoom levels

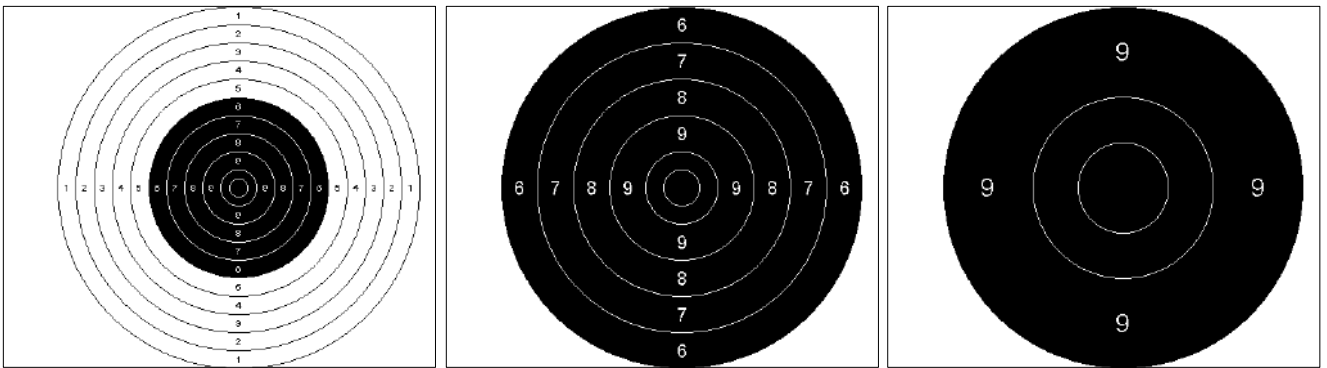

Technical data

Part No	735-0097-97-0005
Size	N/A
Gauge (default)	8 mm
Aiming mark diameter	500 mm
Manufacture	
Manufacture Part No	

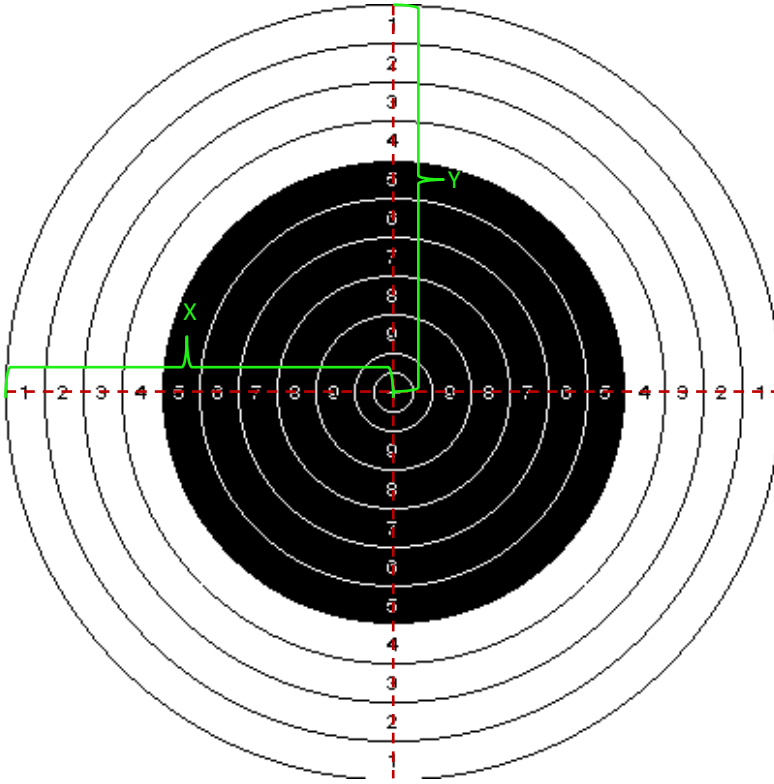

Diameter (mm)	Value
50	*
100	X
200	9
300	8
400	7
500	6
600	5
700	4
800	3
900	2
1000	1

X	500 mm
Y	500 mm

Zoom levels

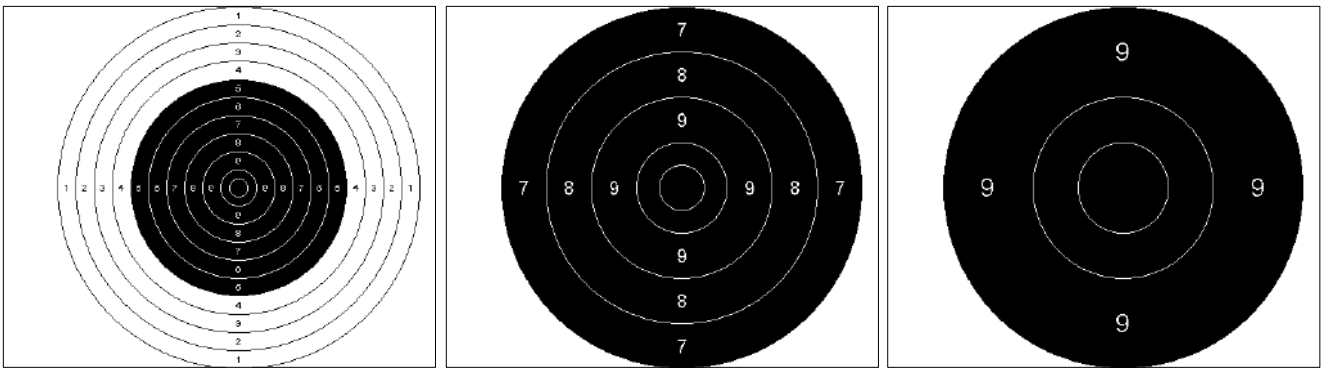

Technical data

Part No	735-0097-97-0006
Size	N/A
Gauge (default)	8 mm
Aiming mark diameter	600 mm
Manufacture	
Manufacture Part No	

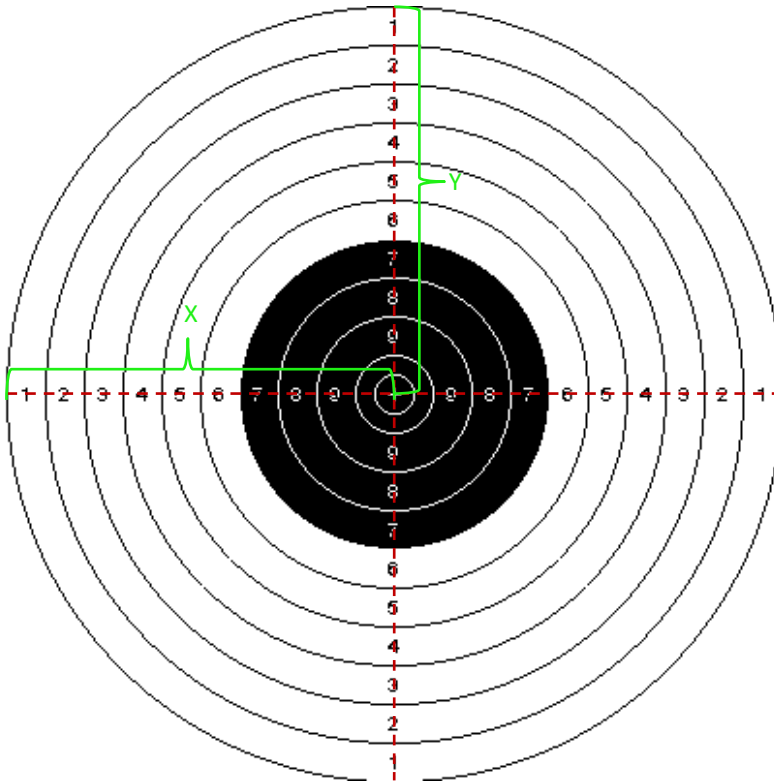

Diameter (mm)	Value
25	*
50	X
100	9
150	8
200	7
250	6
300	5
350	4
400	3
450	2
500	1

X	250 mm
Y	250 mm

Zoom levels

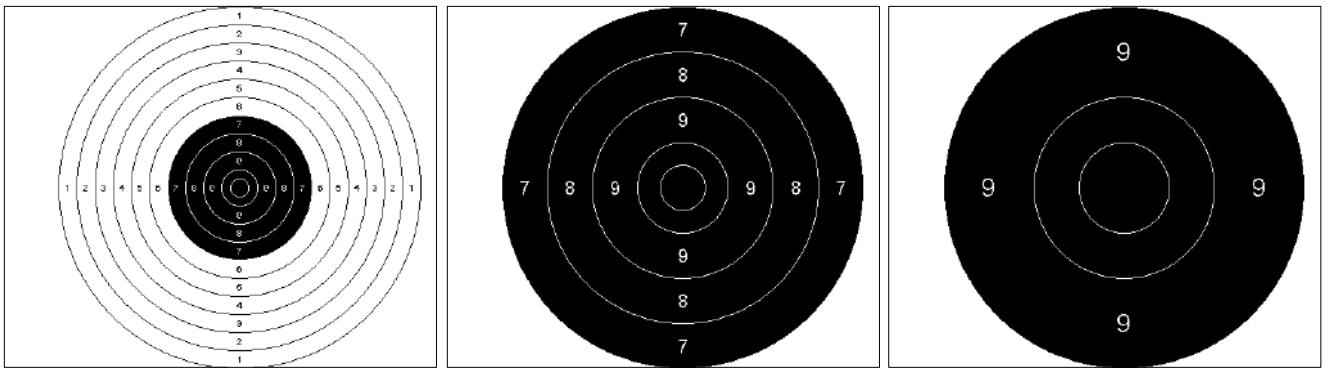

Technical data

Part No	735-0097-97-0007
Size	N/A
Gauge (default)	5,6 mm
Aiming mark diameter	200 mm
Manufacture	
Manufacture Part No	

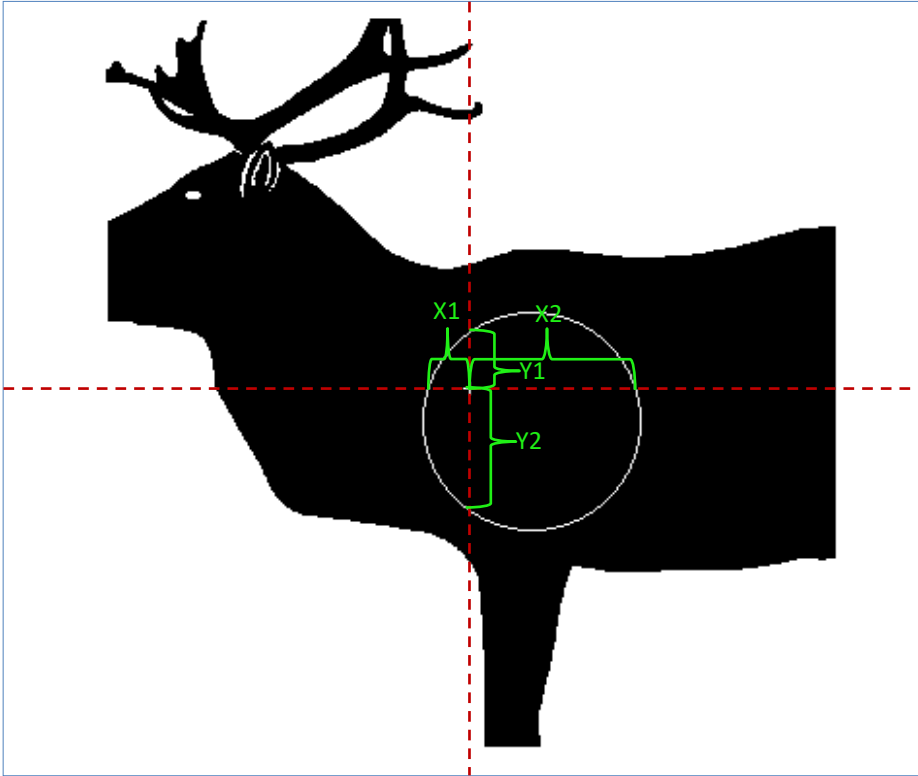

Diameter (mm)	Value
300	X

X1	65 mm	X2	235 mm
Y2	105 mm	Y2	195 mm

Zoom levels

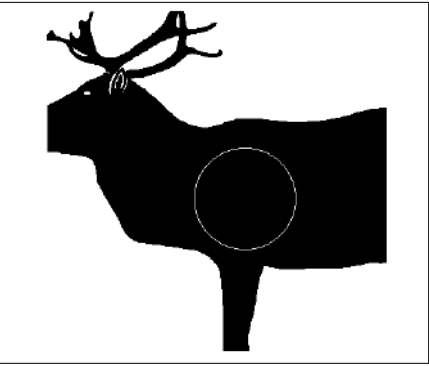

Technical data

Part No	735-0097-97-0008
Size	17 kb
Gauge (default)	8 mm
Aiming mark diameter	
Manufacture	
Manufacture Part No	

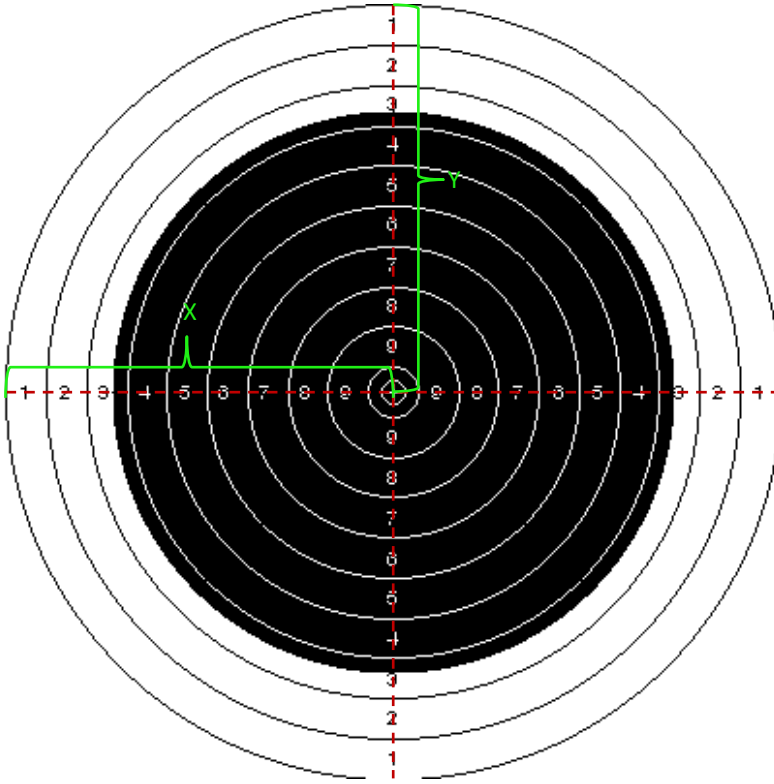

Diameter (mm)	Value
5,0	*
10,4	X
26,4	9
42,4	8
58,4	7
74,4	6
90,4	5
106,4	4
122,4	3
138,4	2
154,4	1

X	77,2 mm
Y	77,2 mm

Zoom levels

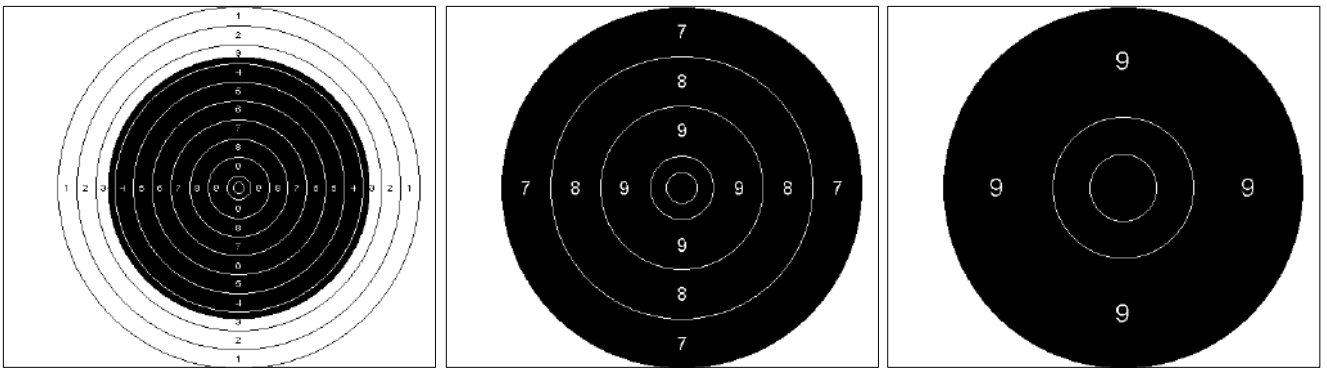

Technical data

Part No	735-0097-97-0011
Size	N/A
Gauge (default)	5,6 mm
Aiming mark diameter	112,4 mm
Manufacture	
Manufacture Part No	

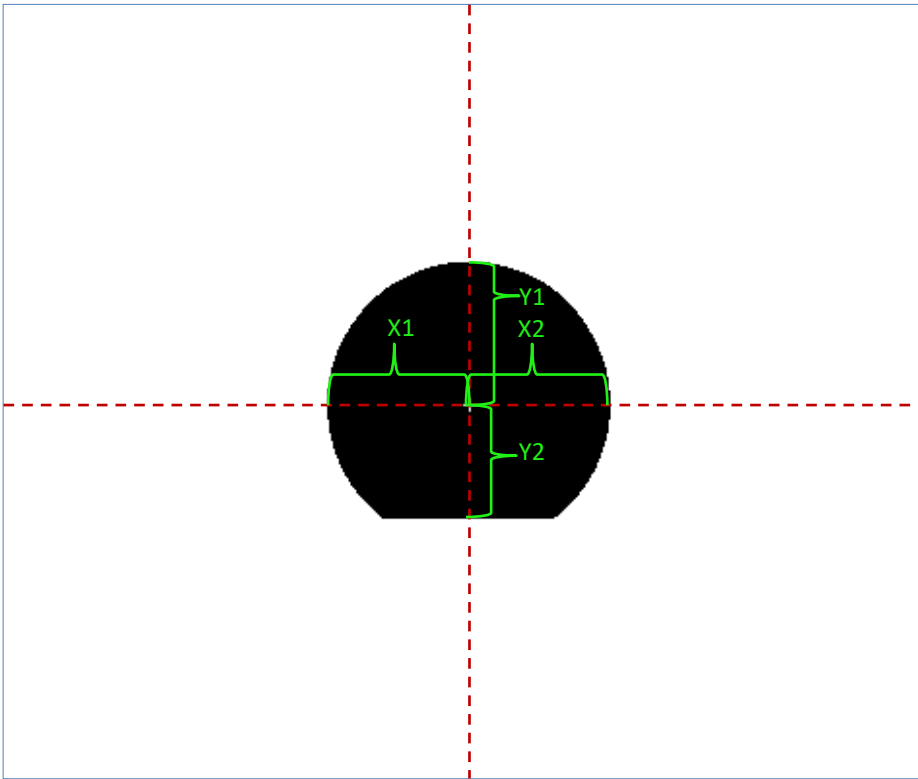

Diameter (mm)	Value

X2	100	X2	100 mm
Y1	100 mm	Y2	80 mm

Zoom levels

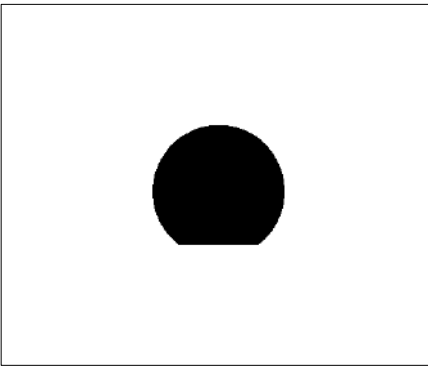

Technical data

Part No	735-0097-97-0017
Size	17 kb
Gauge (default)	8 mm
Aiming mark diameter	
Manufacture	
Manufacture Part No	

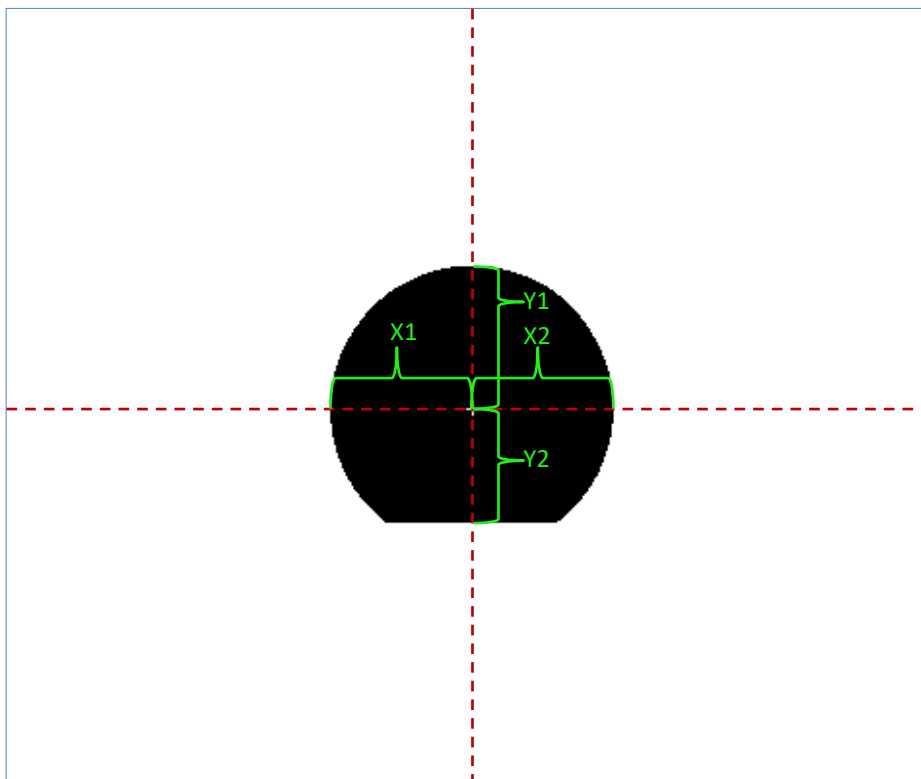

Diameter (mm)	Value

X1	124 mm	X2	124 mm
Y1	124,4 mm	Y2	99,6 mm

Zoom levels

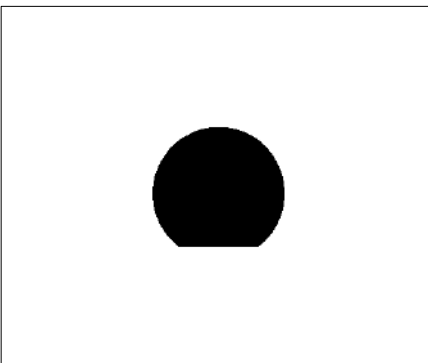

Technical data

Part No	735-0097-97-0018
Size	17 kb
Gauge (default)	8 mm
Aiming mark diameter	
Manufacture	
Manufacture Part No	

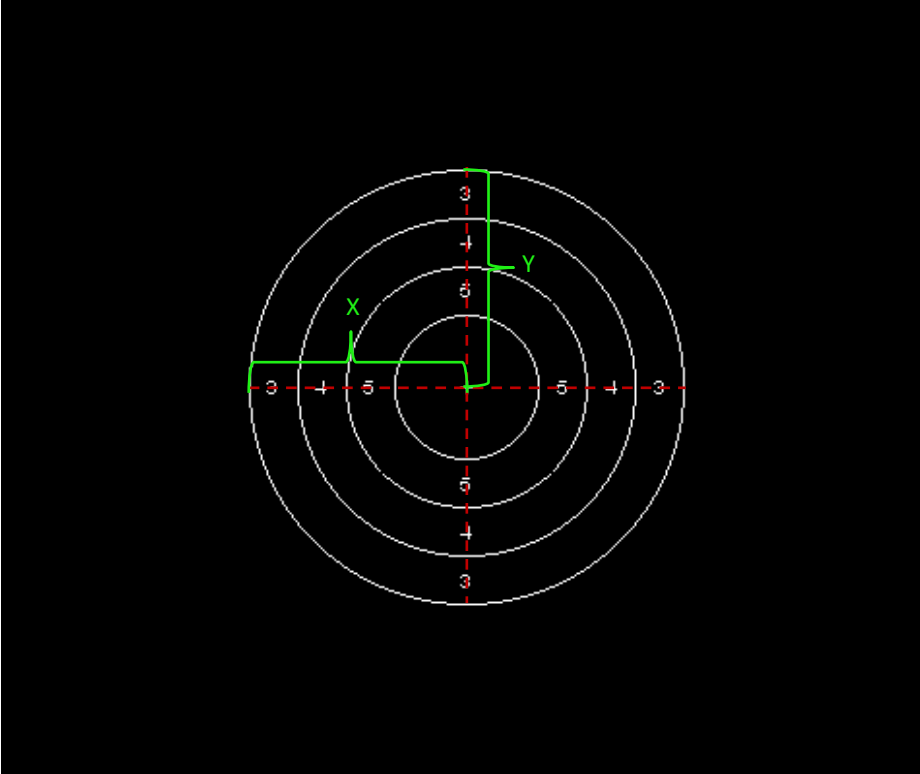

Diameter (mm)	Value
150	*
250	5
350	4
450	3

X	225 mm
Y	225 mm

Zoom levels

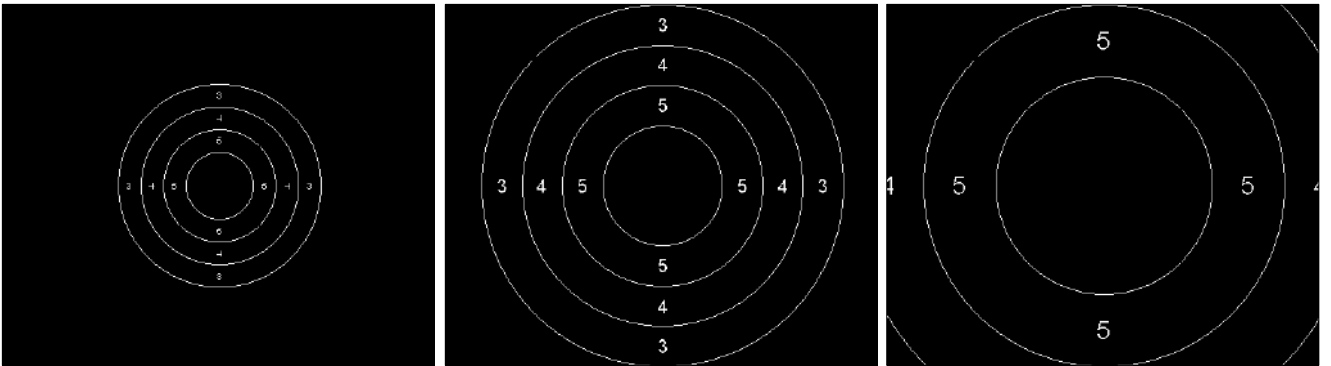

Technical data

Part No	735-0097-97-0020
Size	2 kb
Gauge (default)	8 mm
Aiming mark diameter	450 mm
Manufacture	
Manufacture Part No	

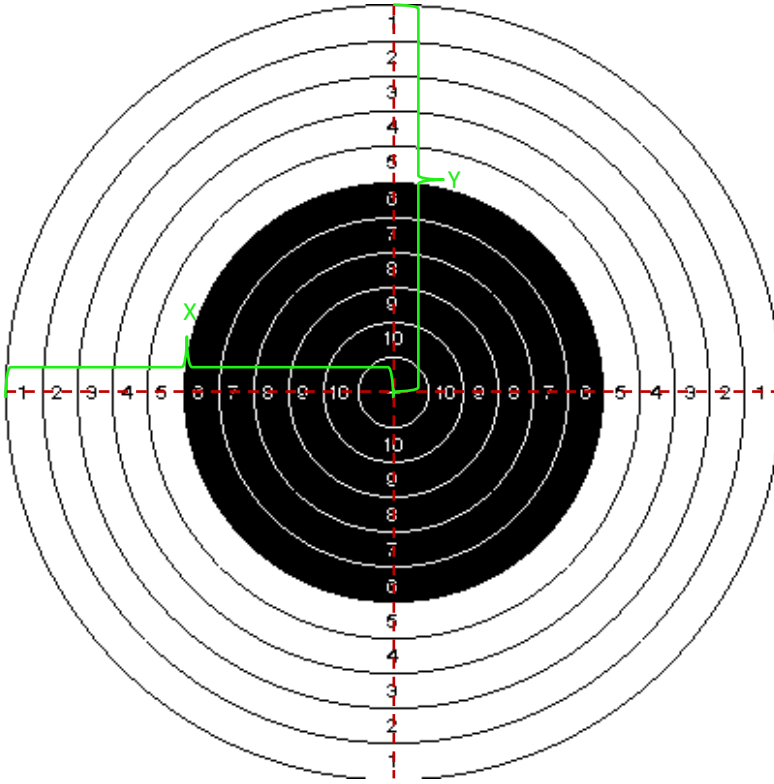

Diameter (mm)	Value
100	*
200	X
300	9
400	8
500	7
600	6
700	5
800	4
900	3
1000	2
1100	1

X	550 mm
Y	550 mm

Zoom levels

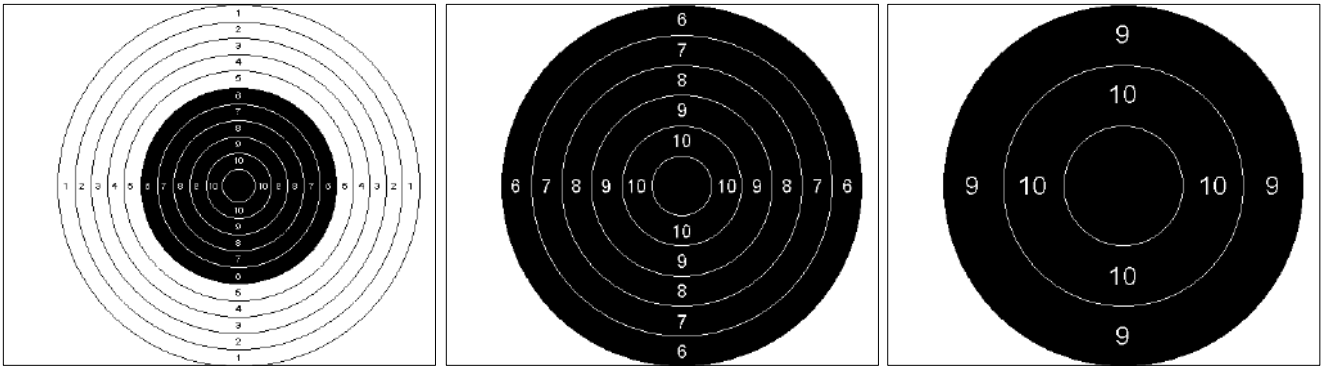

Technical data

Part No	735-0097-97-0021
Size	N/A
Gauge (default)	8 mm
Aiming mark diameter	600 mm
Manufacture	
Manufacture Part No	

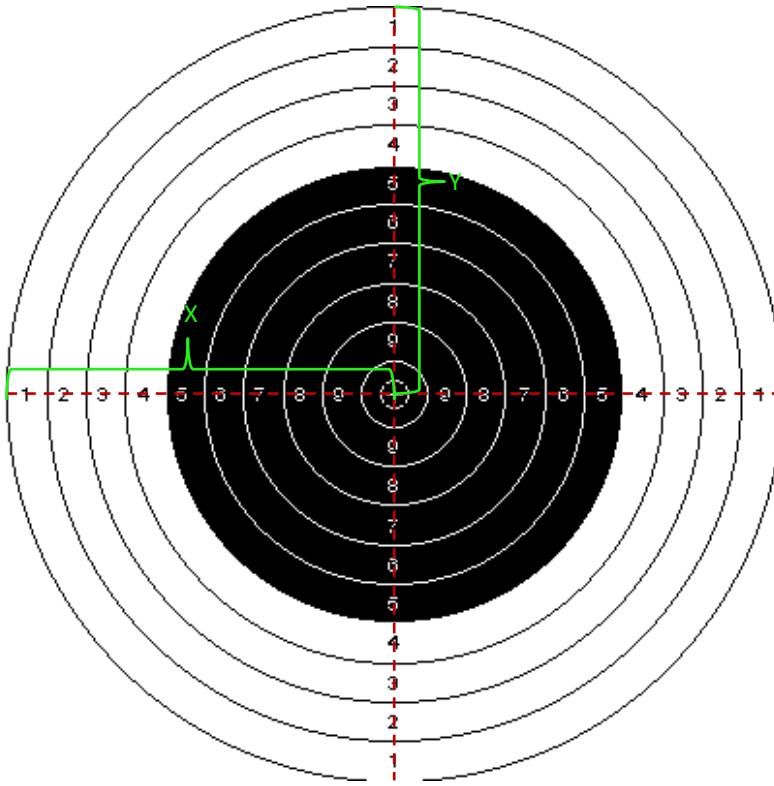

Diameter (mm)	Value
8,9	*
21,4	X
46,4	9
71,4	8
96,4	7
121,4	6
146,4	5
171,4	4
196,4	3
221,4	2
246,4	1

X	77,2 mm
Y	77,2 mm

Zoom levels

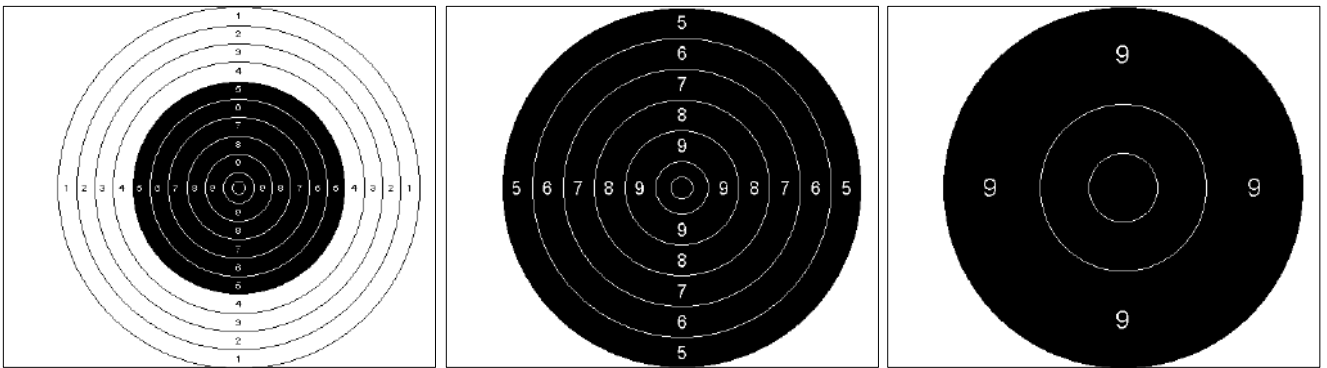

Technical data

Part No	735-0097-97-0023
Size	N/A
Gauge (default)	5,6 mm
Aiming mark diameter	146,4 mm
Manufacture	
Manufacture Part No	

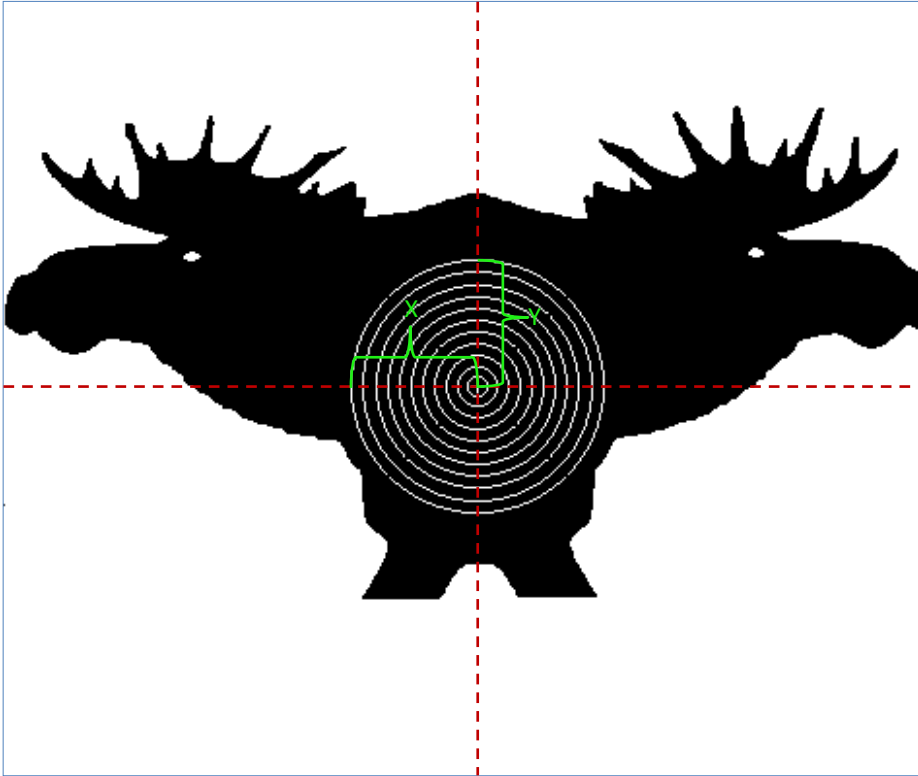

Diameter (mm)	Value
48	*
96	X
150,4	9
204,8	8
259,2	7
313,6	6
368	5
422,4	4
476,8	3
531,2	2
585,6	1

X	292,8 mm
Y	292,8 mm

Zoom levels

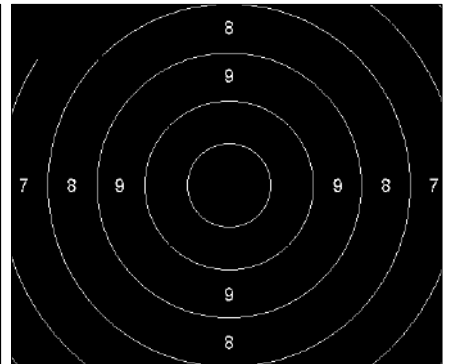
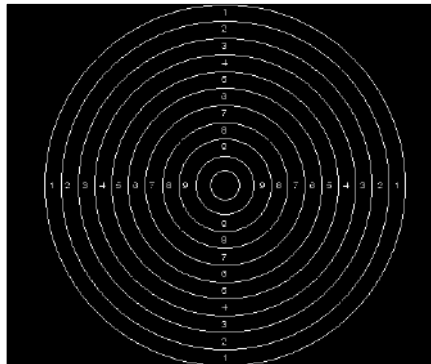
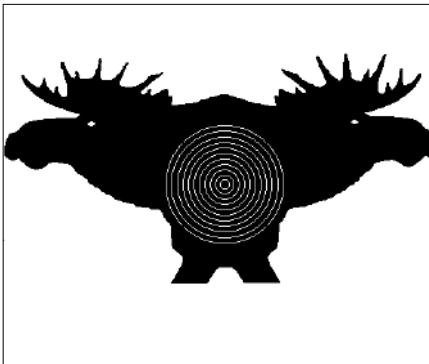

Technical data

Part No	735-0097-97-0027
Size	19 kb
Gauge (default)	8 mm
Aiming mark diameter	585,6
Manufacture	
Manufacture Part No	

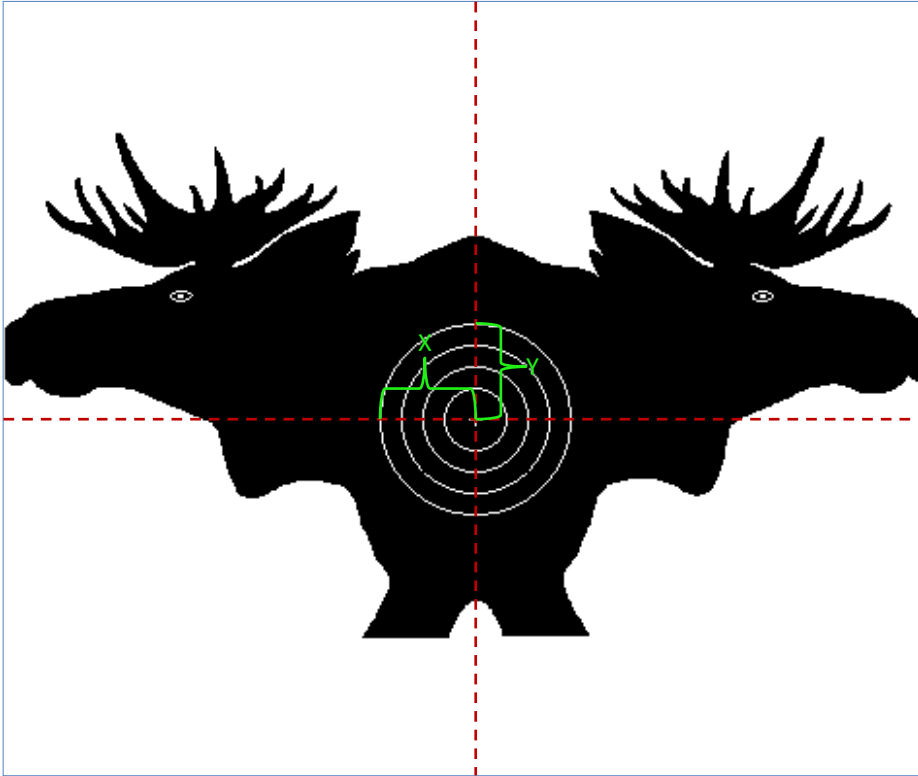

Diameter (mm)	Value
150	*
250	5
350	4
450	3

X	225 mm
Y	225 mm

Zoom levels

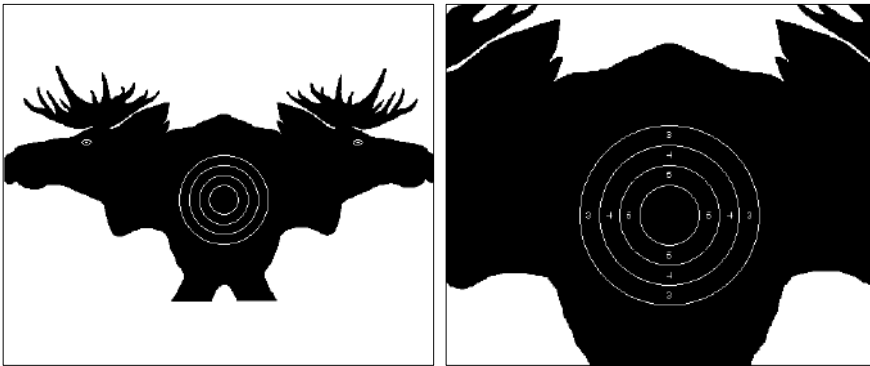

Technical data

Part No	735-0097-97-0030
Size	36 kb
Gauge (default)	8 mm
Aiming mark diameter	450 mm
Manufacture	
Manufacture Part No	

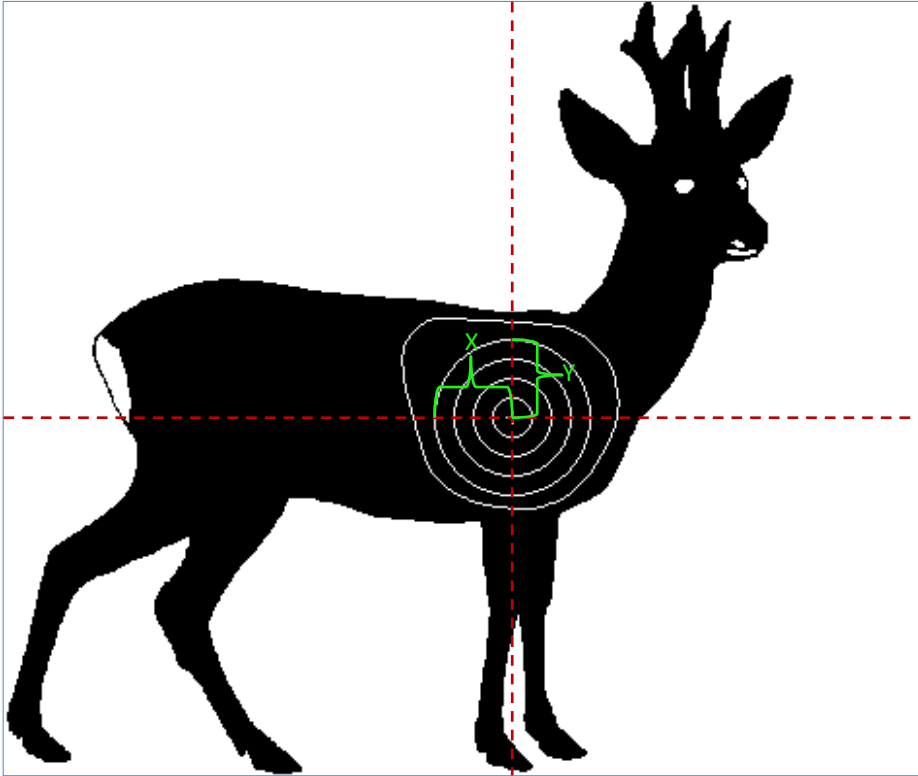

Diameter (mm)	Value
50	*
100	5
150	4
200	3

X	100 mm
Y	100 mm

Zoom levels

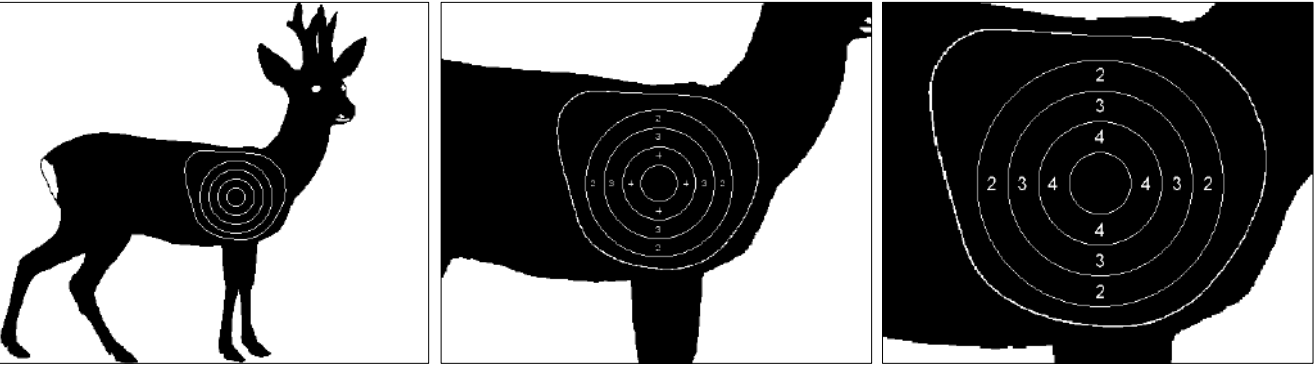

Technical data

Part No	735-0097-97-0031
Size	54 kb
Gauge (default)	8 mm
Aiming mark diameter	200 mm
Manufacture	
Manufacture Part No	

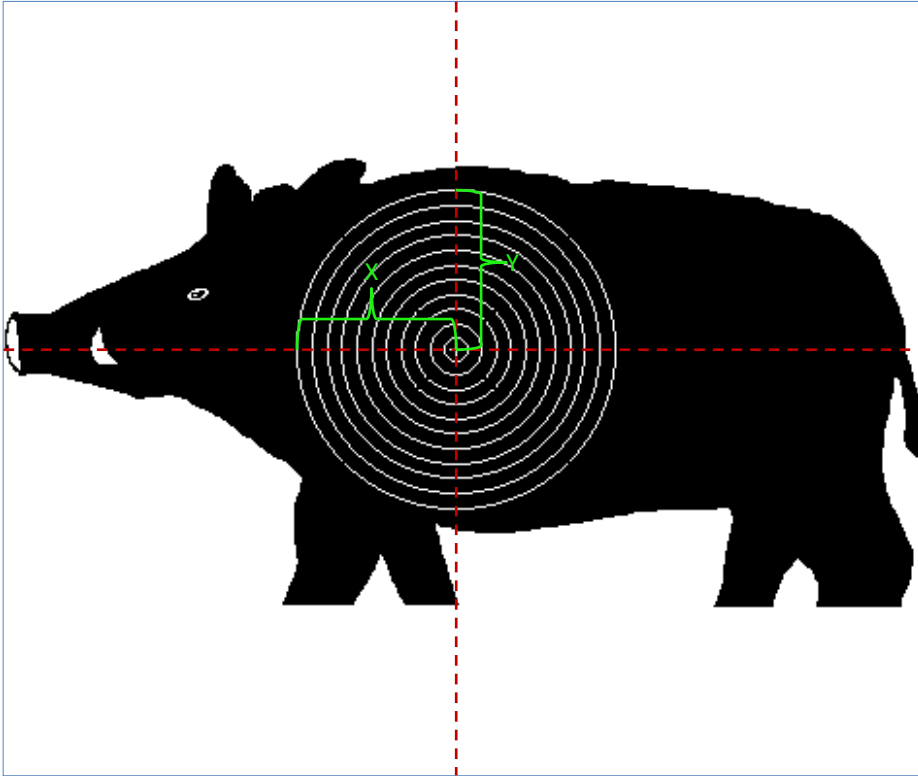

Diameter (mm)	Value
30	*
60	X
94	9
128	8
162	7
196	6
230	5
264	4
298	3
332	2
366	1

X	183 mm
Y	183 mm

Zoom levels

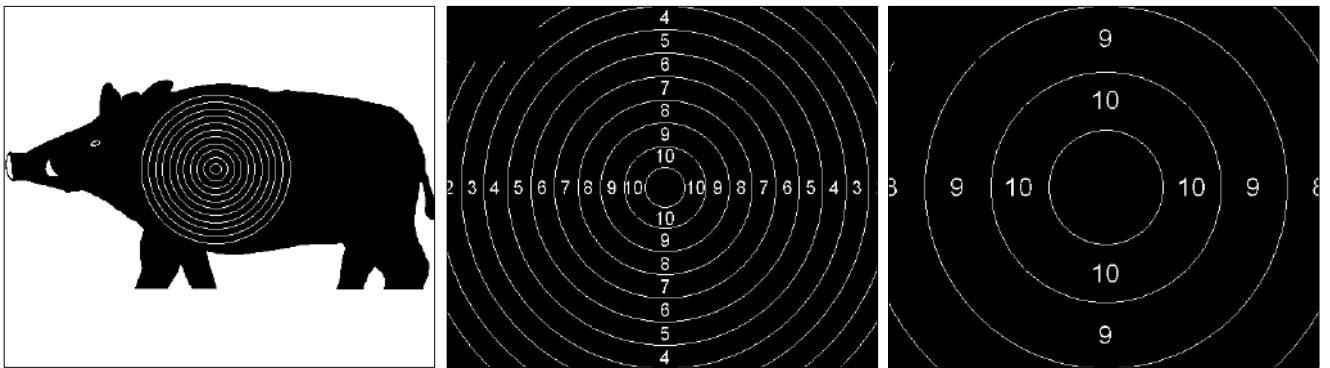

Technical data

Part No	735-0097-97-0032
Size	17 kb
Gauge (default)	8 mm
Aiming mark diameter	366 mm
Manufacture	
Manufacture Part No	

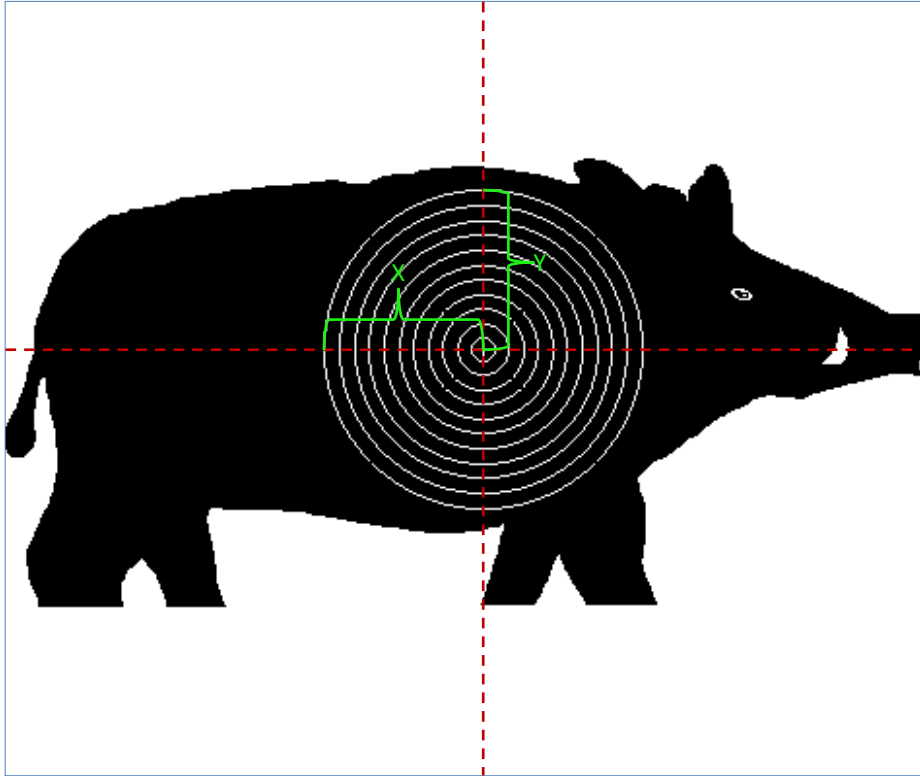

Diameter (mm)	Value
30	*
60	X
94	9
128	8
162	7
196	6
230	5
264	4
298	3
332	2
366	1

X	183 mm
Y	183 mm

Zoom levels

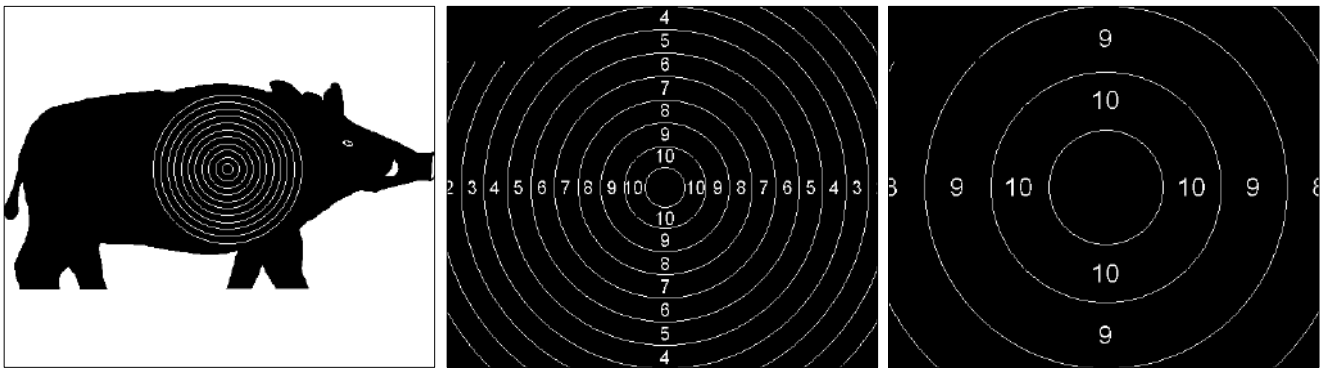

Technical data

Part No	735-0097-97-0033
Size	17 kb
Gauge (default)	8 mm
Aiming mark diameter	366 mm
Manufacture	
Manufacture Part No	

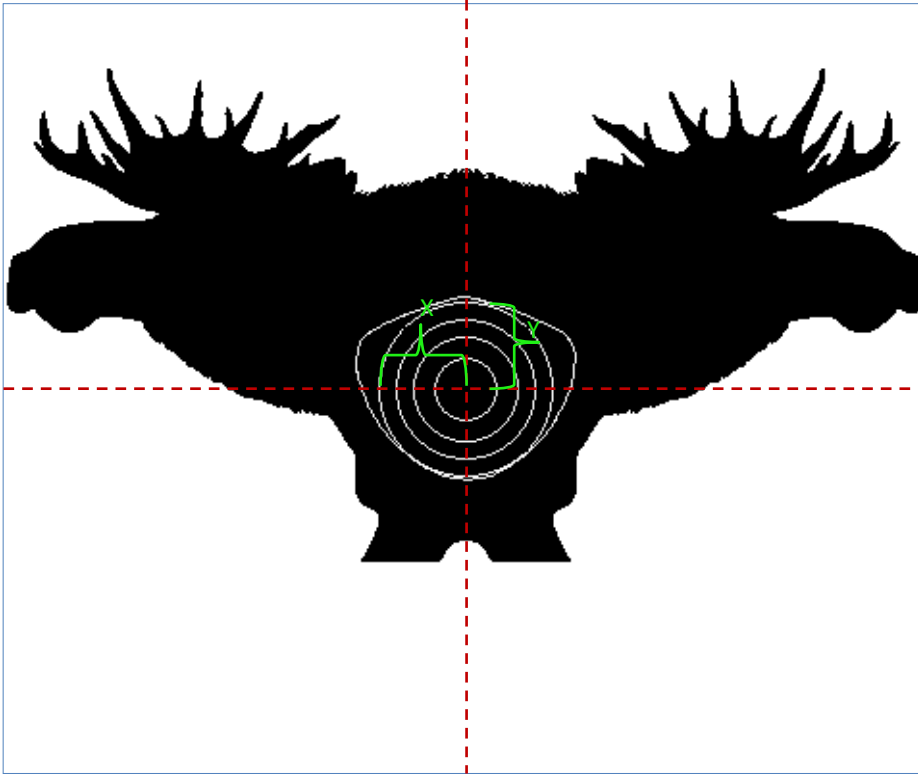

Diameter (mm)	Value
150	*
250	5
332	4
414	3

X	207 mm
Y	207 mm

Zoom levels

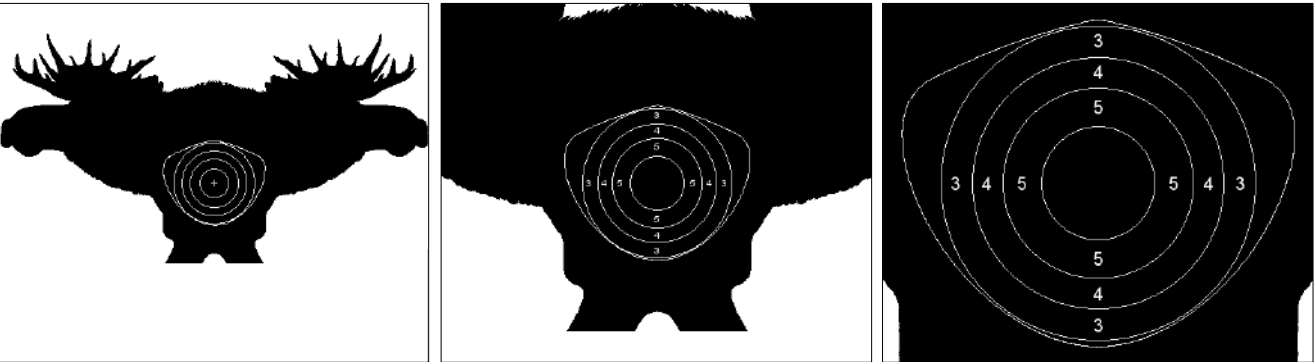

Technical data

Part No	735-0097-97-0034
Size	25 kb
Gauge (default)	8 mm
Aiming mark diameter	414 mm
Manufacture	
Manufacture Part No	

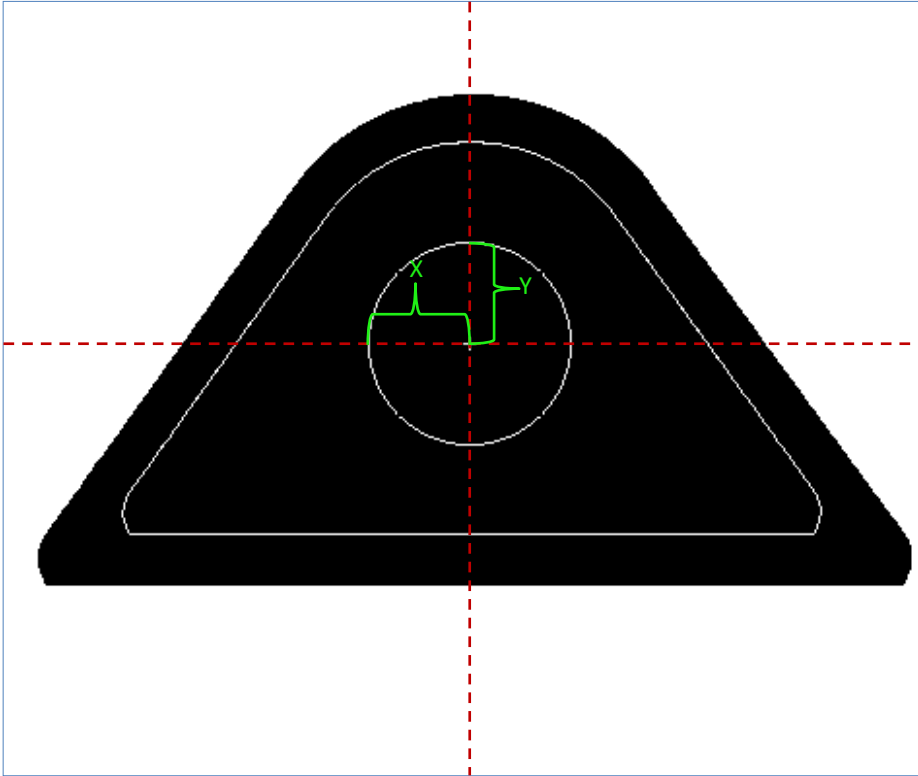

Diameter (mm)	Value
105	*

X	52,5 mm
Y	52,5 mm

Zoom levels

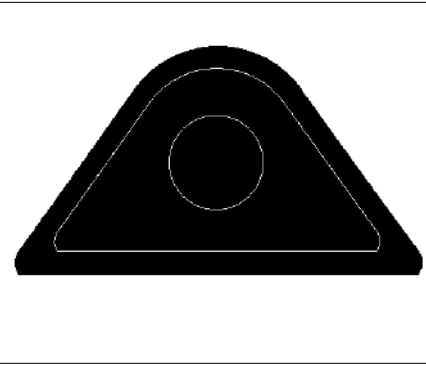

Technical data

Part No	735-0097-97-0035
Size	42 kb
Gauge (default)	8 mm
Aiming mark diameter	105 mm
Manufacture	
Manufacture Part No	

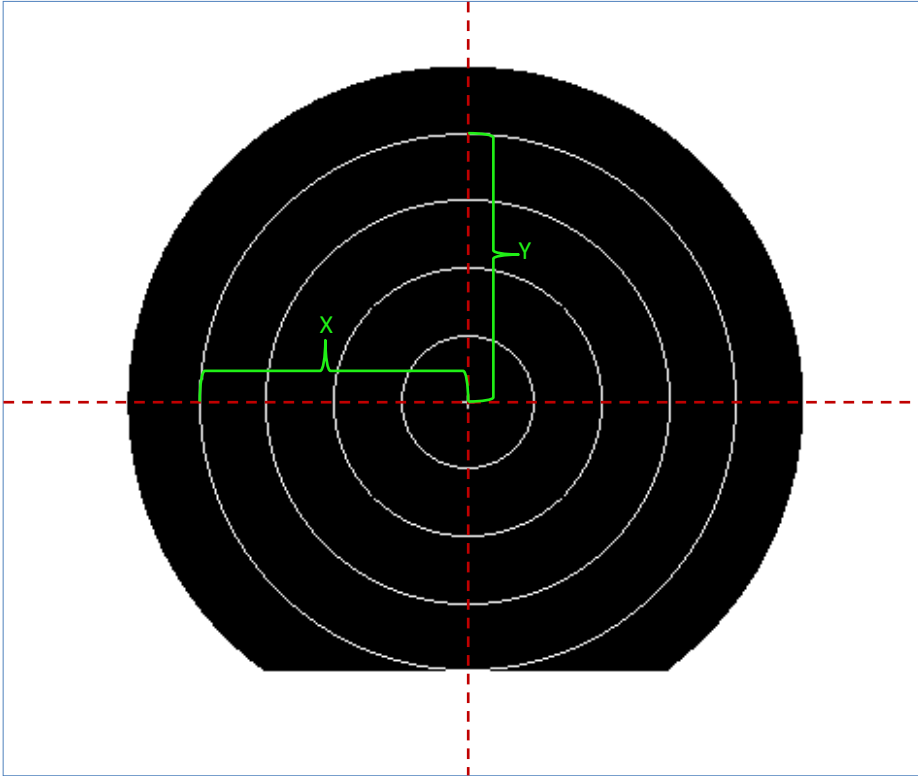

Diameter (mm)	Value
80	5
160	4
240	3
320	2

X	160 mm
Y	160 mm

Zoom levels

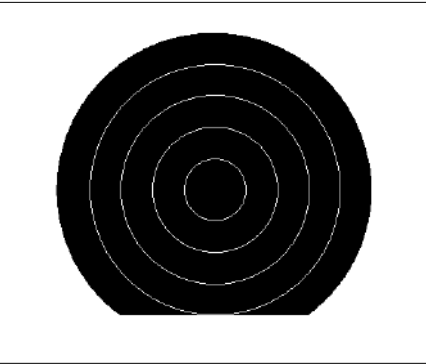

Technical data

Part No	735-0097-97-0036
Size	26 kb
Gauge (default)	8 mm
Aiming mark diameter	320 mm
Manufacture	
Manufacture Part No	

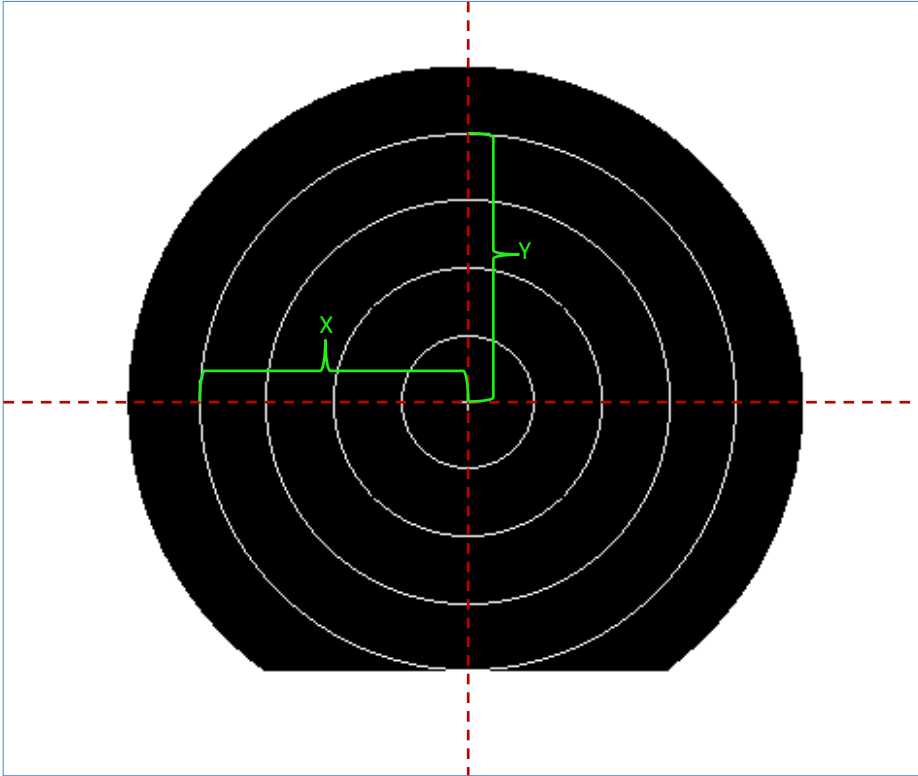

Diameter (mm)	Value
60	5
120	4
180	3
240	2

X	120 mm
Y	120 mm

Zoom levels

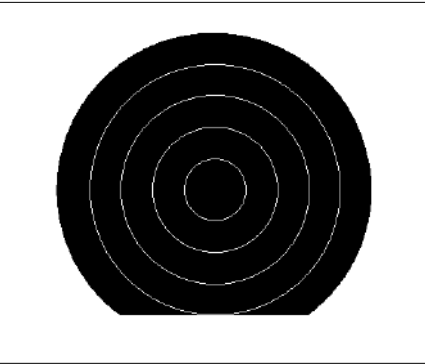

Technical data

Part No	735-0097-97-0037
Size	26 kb
Gauge (default)	8 mm
Aiming mark diameter	240 mm
Manufacture	
Manufacture Part No	

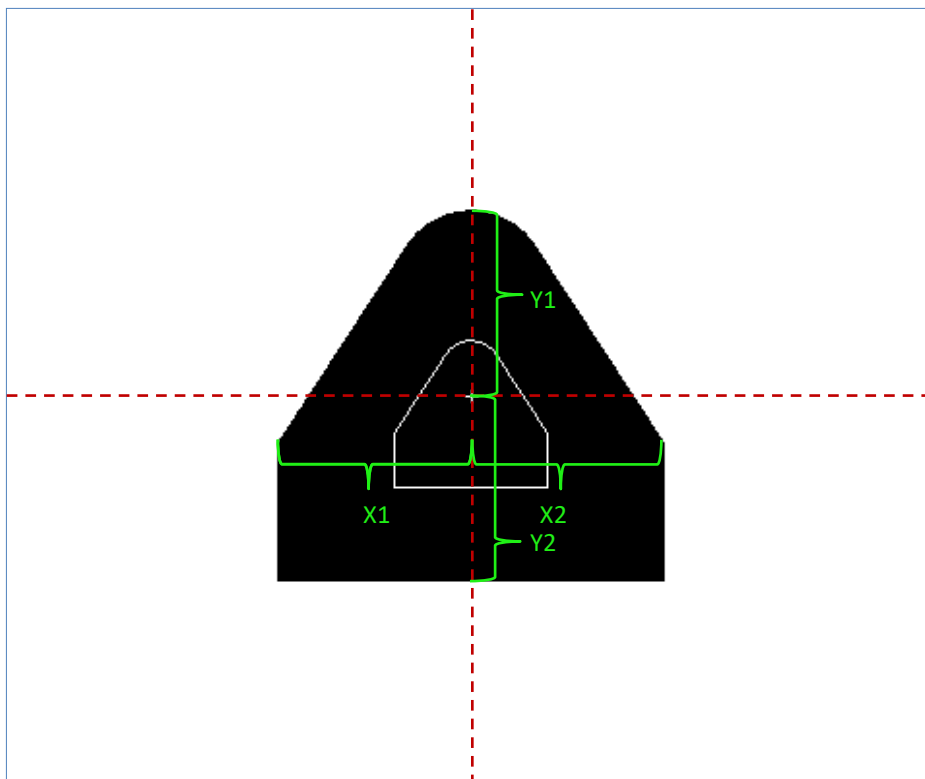

Diameter (mm)	Value

X1	250 mm	X2	250 mm
Y1	240 mm	Y2	240 mm

Zoom levels

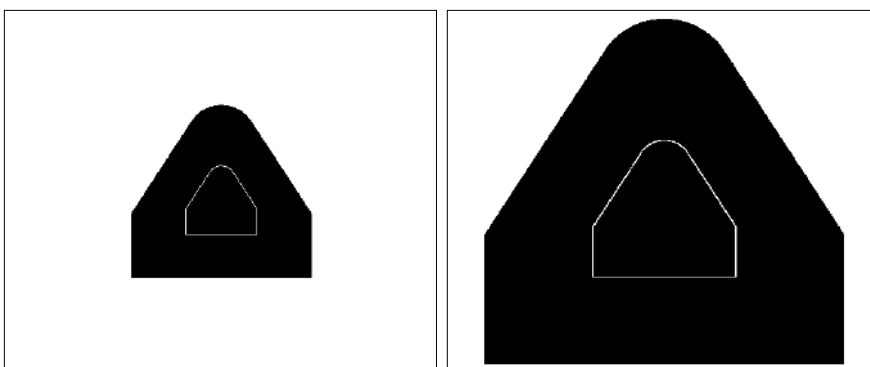

Technical data

Part No	735-0097-97-0038
Size	56 kb
Gauge (default)	8 mm
Aiming mark diameter	
Manufacture	
Manufacture Part No	

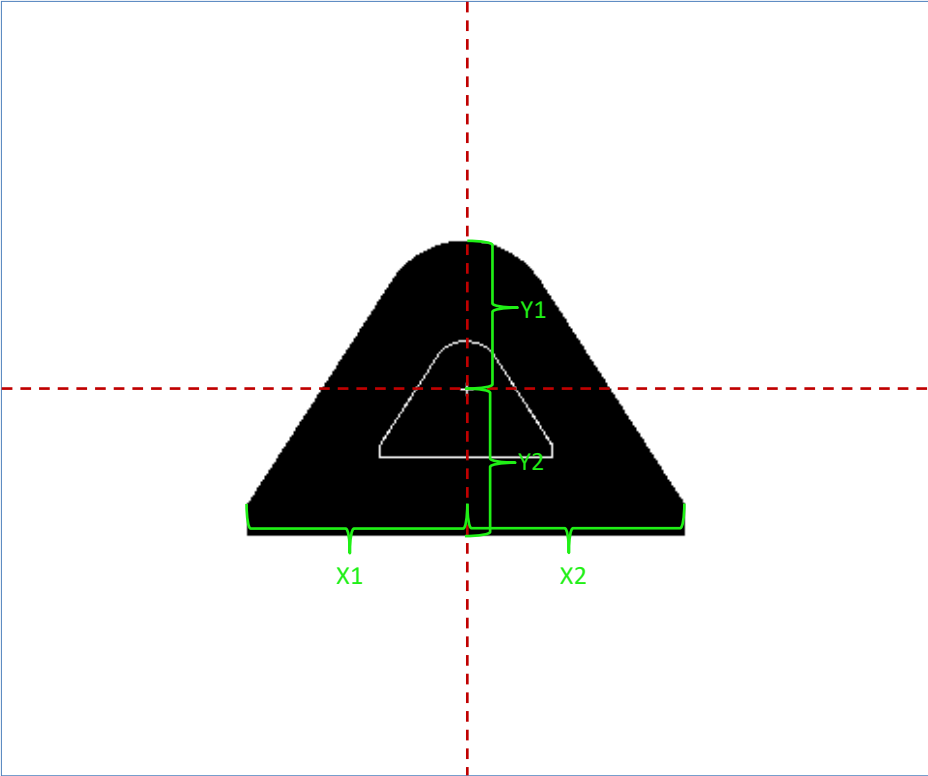

Diameter (mm)	Value

X1	245 mm	X2	245 mm
Y1	165 mm	Y2	165 mm

Zoom levels

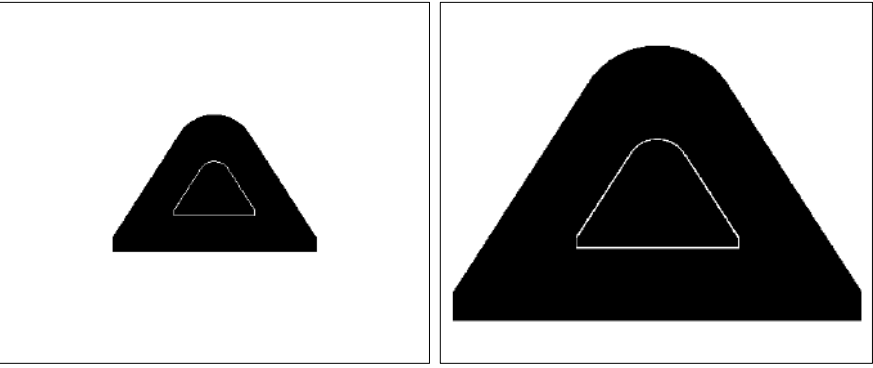

Technical data

Part No	735-0097-97-0039
Size	48 kb
Gauge (default)	8 mm
Aiming mark diameter	
Manufacture	
Manufacture Part No	

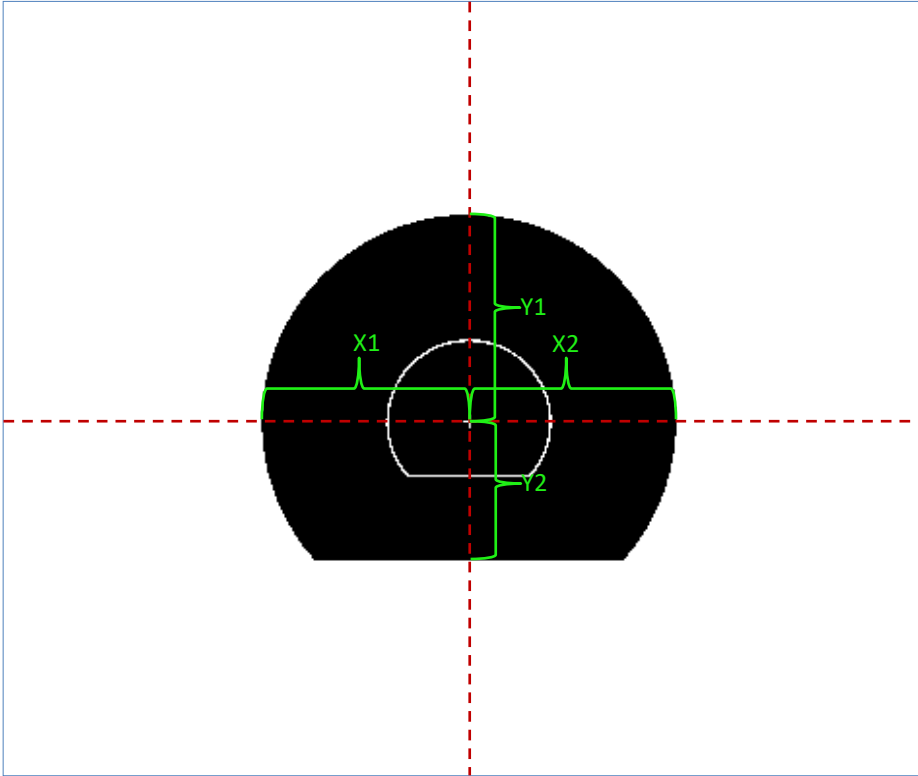

Diameter (mm)	Value

X1	150 mm	X2	150 mm
Y1	150 mm	Y2	100 mm

Zoom levels

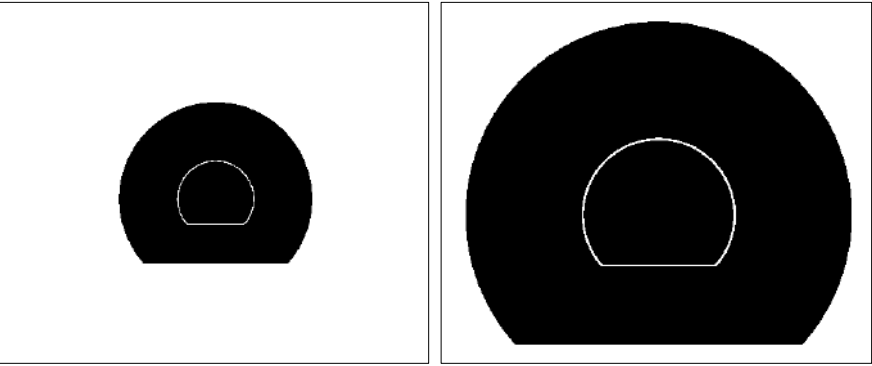

Technical data

Part No	735-0097-97-0040
Size	53 kb
Gauge (default)	8 mm
Aiming mark diameter	
Manufacture	
Manufacture Part No	

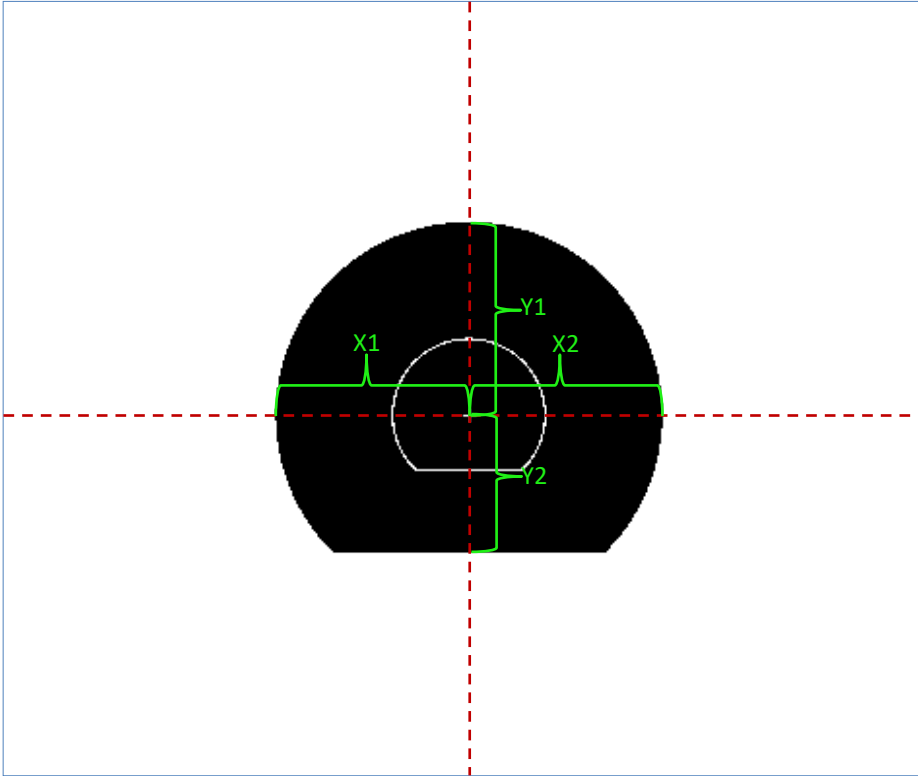

Diameter (mm)	Value

X1	175 mm	X2	175 mm
Y1	175 mm	Y2	125mm

Zoom levels

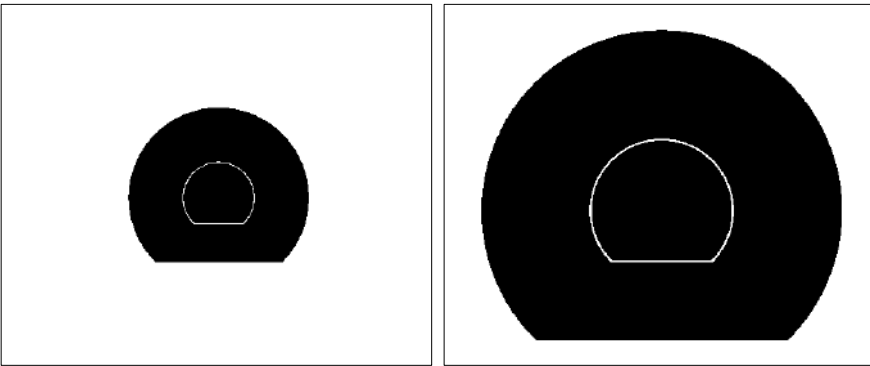

Technical data

Part No	735-0097-97-0041
Size	52 kb
Gauge (default)	8 mm
Aiming mark diameter	
Manufacture	
Manufacture Part No	

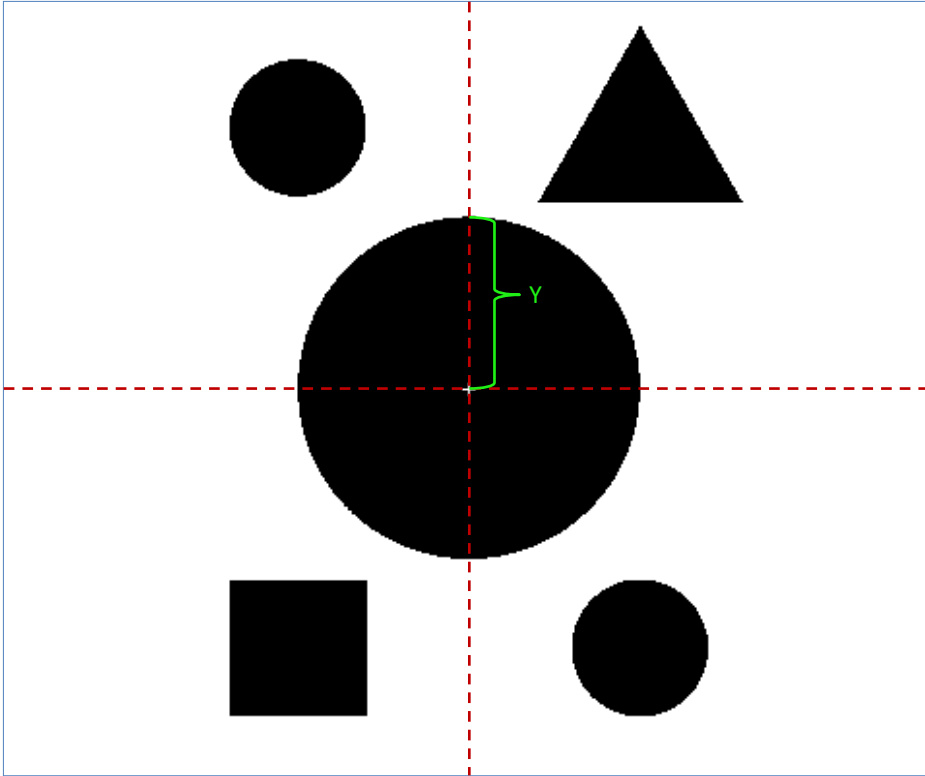

Diameter (mm)	Value

Y	125 mm

Zoom levels

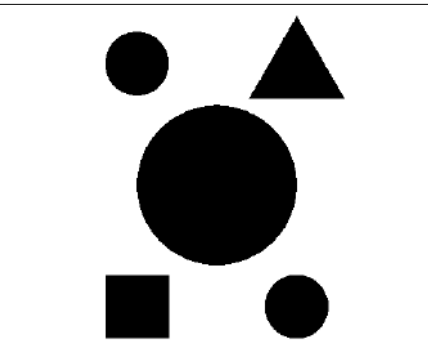

Technical data

Part No	735-0097-97-0042
Size	34 kb
Gauge (default)	8 mm
Aiming mark diameter	
Manufacture	
Manufacture Part No	

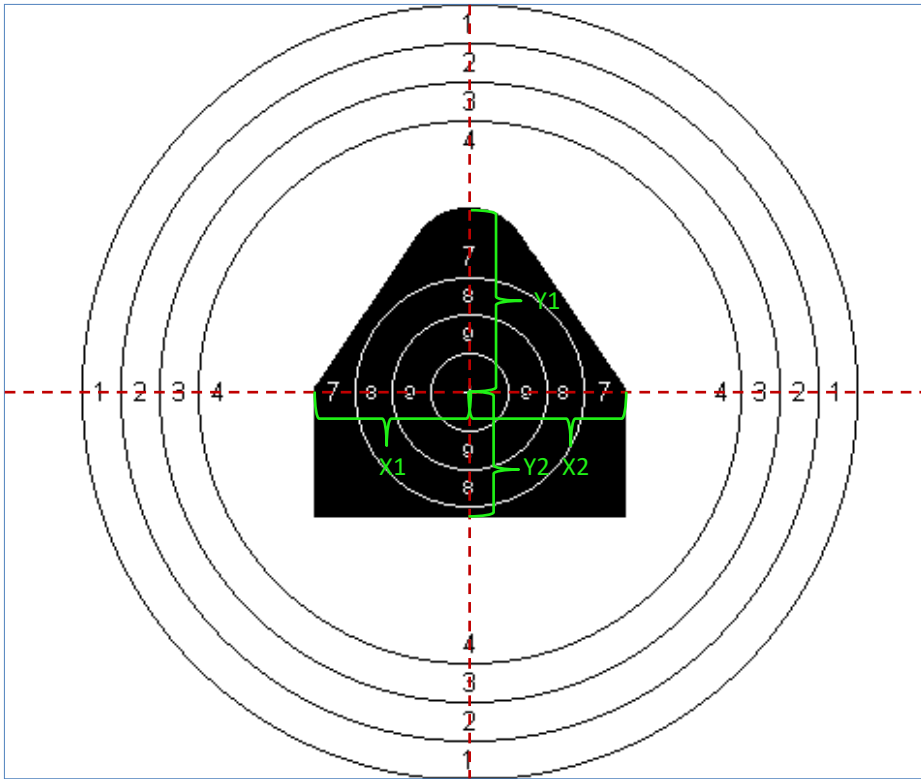

Diameter (mm)	Value
125	X
250	9
375	8
875	4
1000	3
1125	2
1250	1

X1	250 mm	X2	250 mm
Y1	297,5 mm	Y2	202,5 mm

Zoom levels

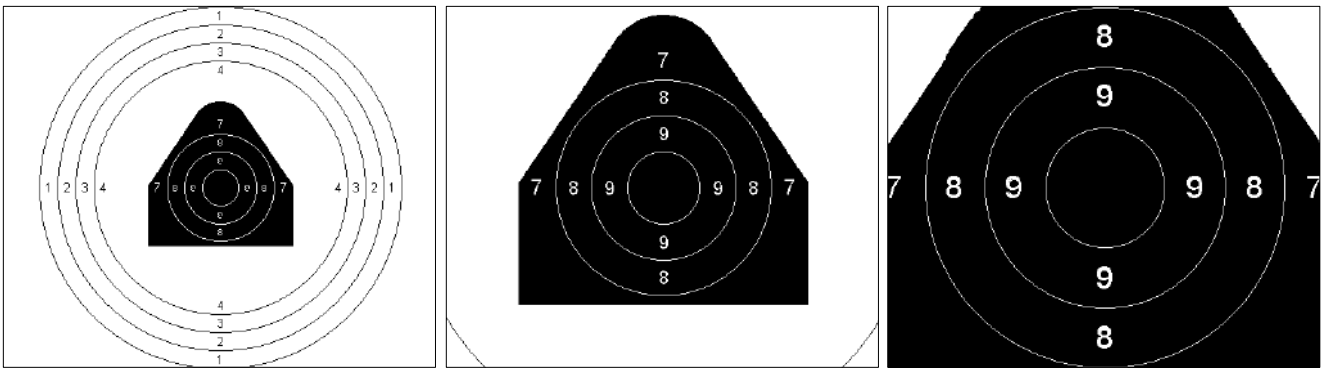

Technical data

Part No	735-0097-97-0043
Size	159 kb
Gauge (default)	8 mm
Aiming mark diameter	
Nato Stock Number	9310-22-620-4193
MED Part No:	1013006

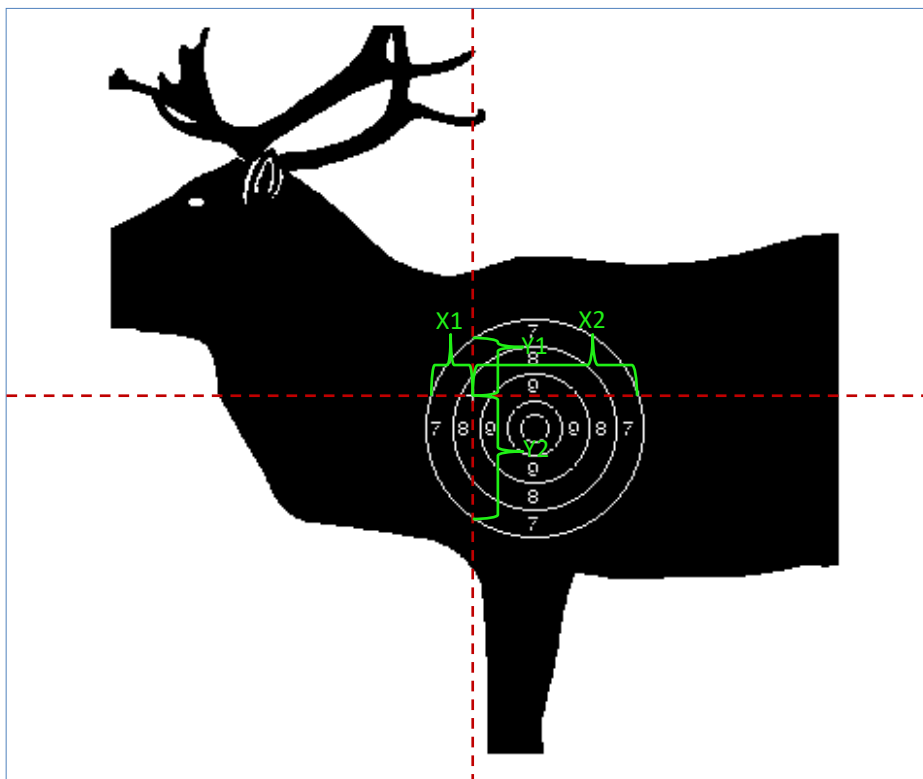

Diameter (mm)	Value
37,5	*
75	X
150	9
225	8
300	7

X1	65 mm	X2	235 mm
Y1	105 mm	Y2	195 mm

Zoom levels

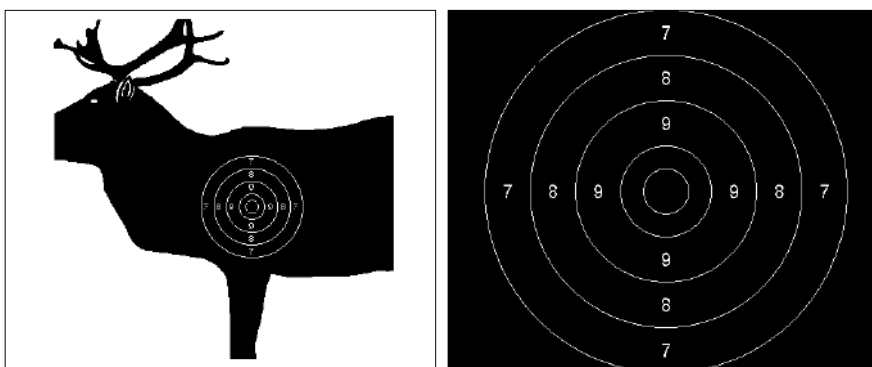

Technical data

Part No	735-0097-97-0044
Size	17 kb
Gauge (default)	8 mm
Aiming mark diameter	
Manufacture	
Manufacture Part No	

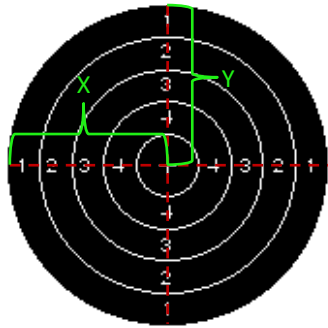

Diameter (mm)	Value
33,2	5
66,4	4
99,6	3
132,8	2
166	1

X	83 mm
Y	83 mm

Zoom levels

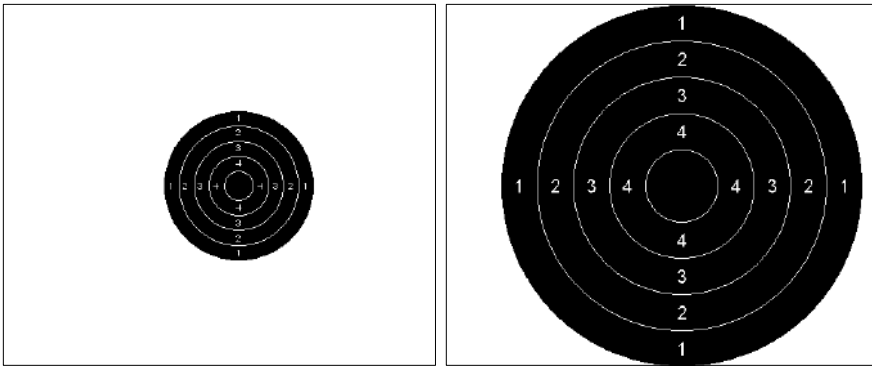

Technical data

Part No	735-0097-97-0045
Size	159 kb
Gauge (default)	8 mm
Aiming mark diameter	166
Manufacture	
Manufacture Part No	

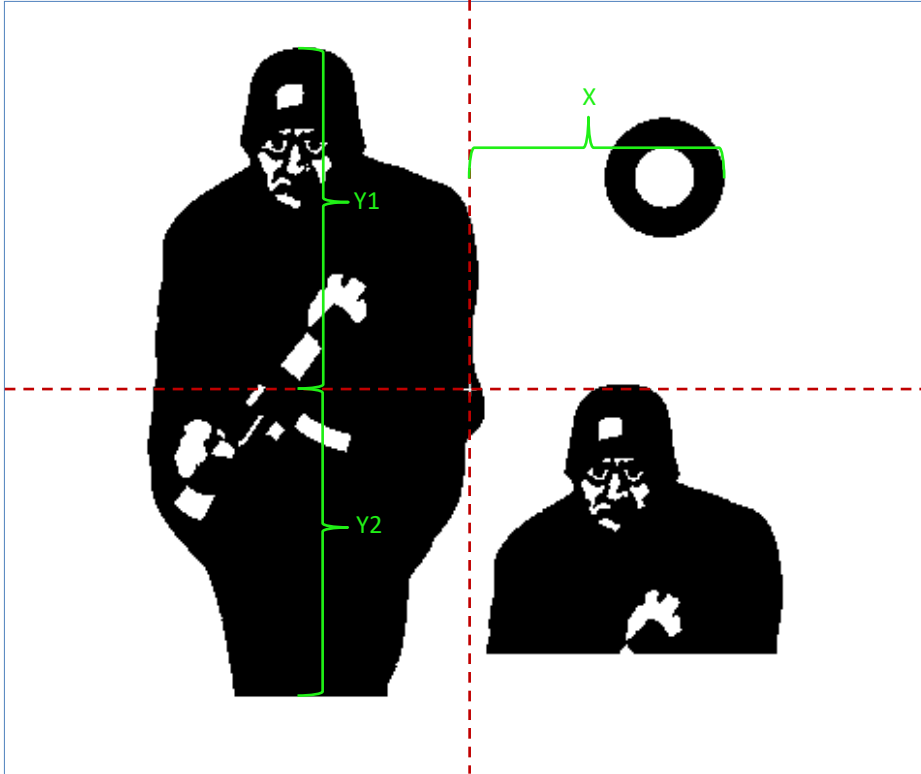

Diameter (mm)	Value

X	425,8 mm		
Y1	568,75 mm	Y2	514,15 mm

Zoom levels

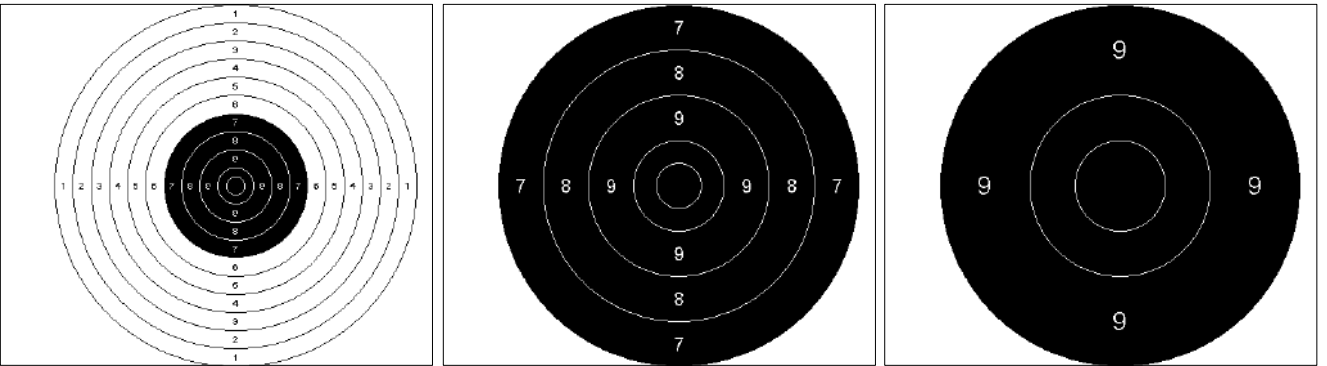

Technical data

Part No	735-0097-97-0046
Size	69 kb
Gauge (default)	8 mm
Aiming mark diameter	
Manufacture	
Manufacture Part No	

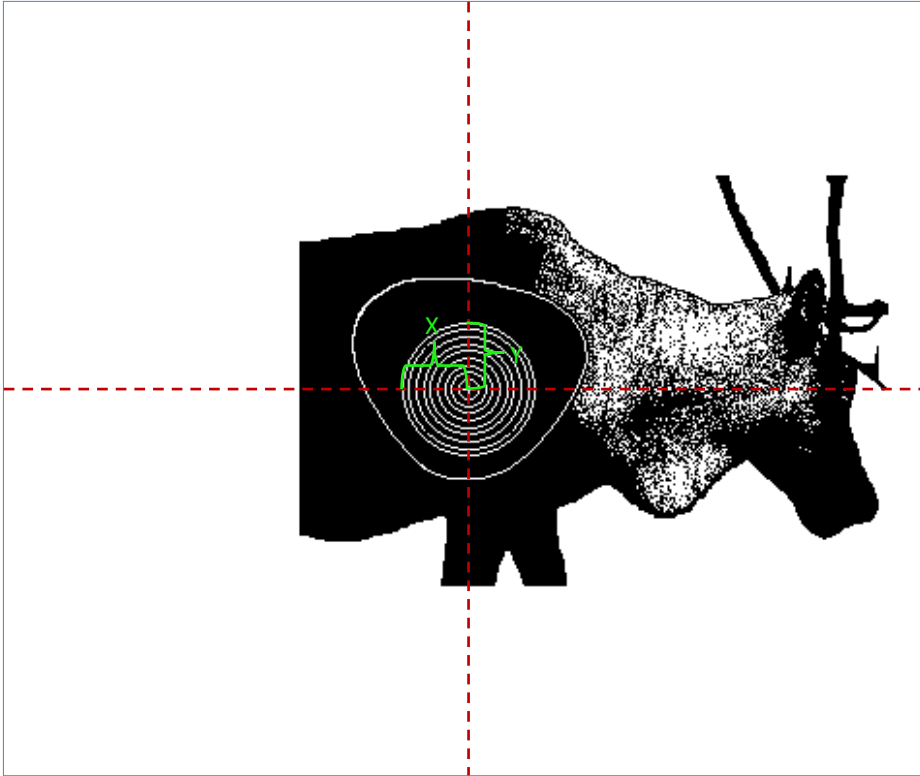

Diameter (mm)	Value
36	*
60	9
84	8
108	7
132	6
156	5
180	4
204	3
228	2

X	114 mm
Y	114 mm

Zoom levels

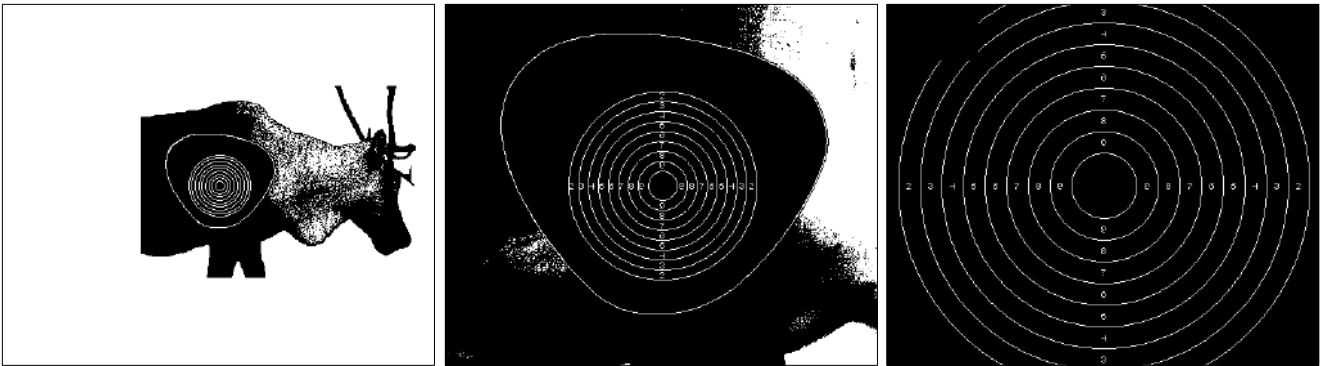

Technical data

Part No	735-0097-97-0047
Size	32 kb
Gauge (default)	8 mm
Aiming mark diameter	228 mm
Manufacture	BEO
Manufacture Part No	BEO-Rein-2

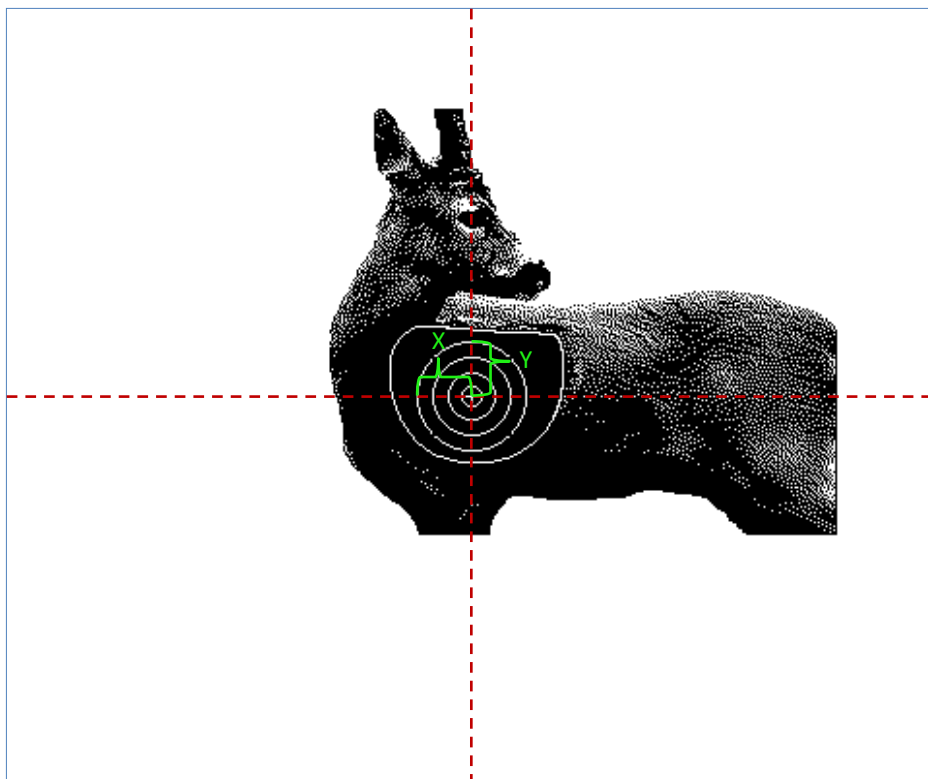

Diameter (mm)	Value
35	5
82	4
135	3
187	2

X	93,5 mm
Y	93,5 mm

Zoom levels

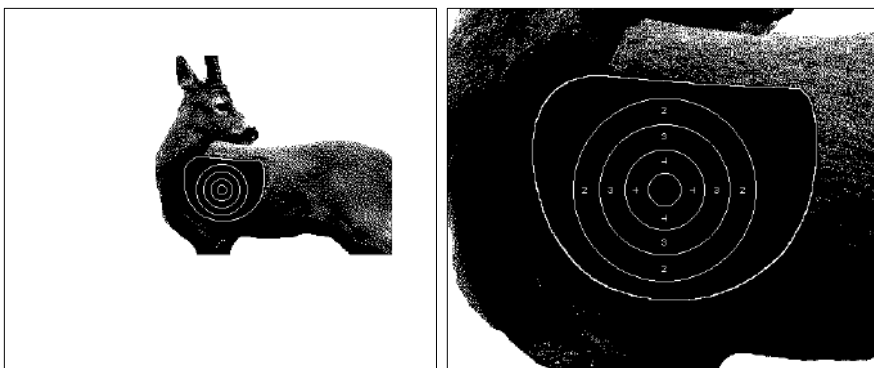

Technical data

Part No	735-0097-97-0048
Size	39
Gauge (default)	8 mm
Aiming mark diameter	187 mm
Manufacture	BEO
Manufacture Part No	BEO-Rådyr-2

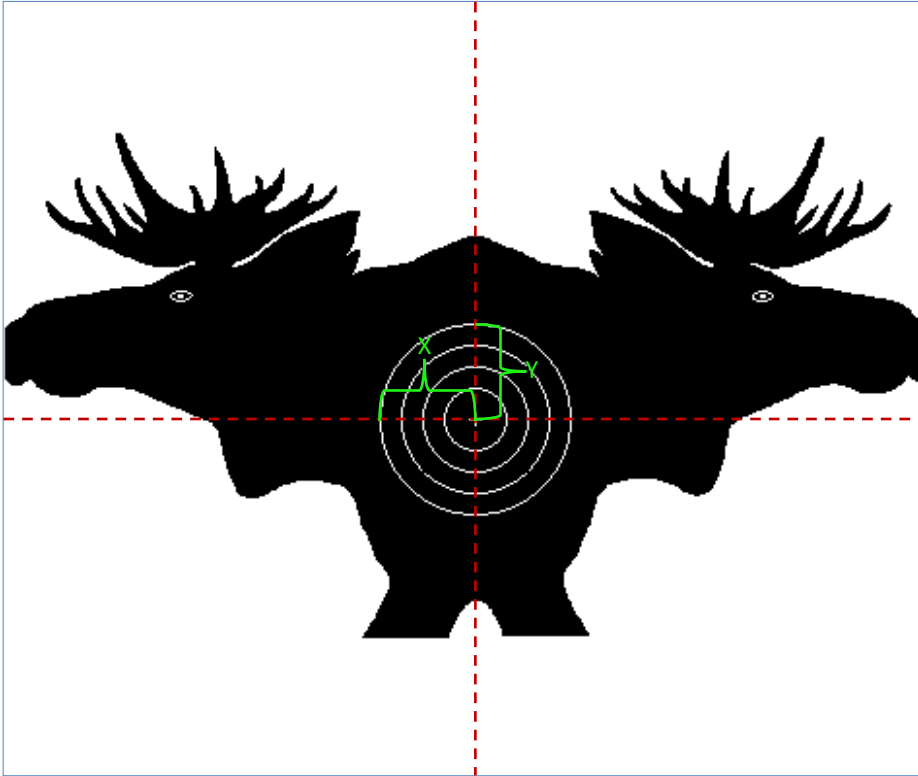

Diameter (mm)	Value
150	10
250	8
350	6
450	4

X	225 mm
Y	225 mm

Zoom levels

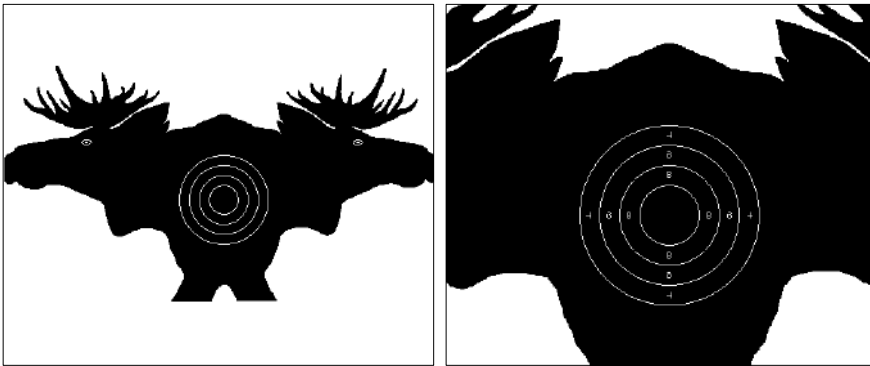

Technical data

Part No	735-0097-97-0049
Size	36 kb
Gauge (default)	8 mm
Aiming mark diameter	450 mm
Manufacture	
Manufacture Part No	

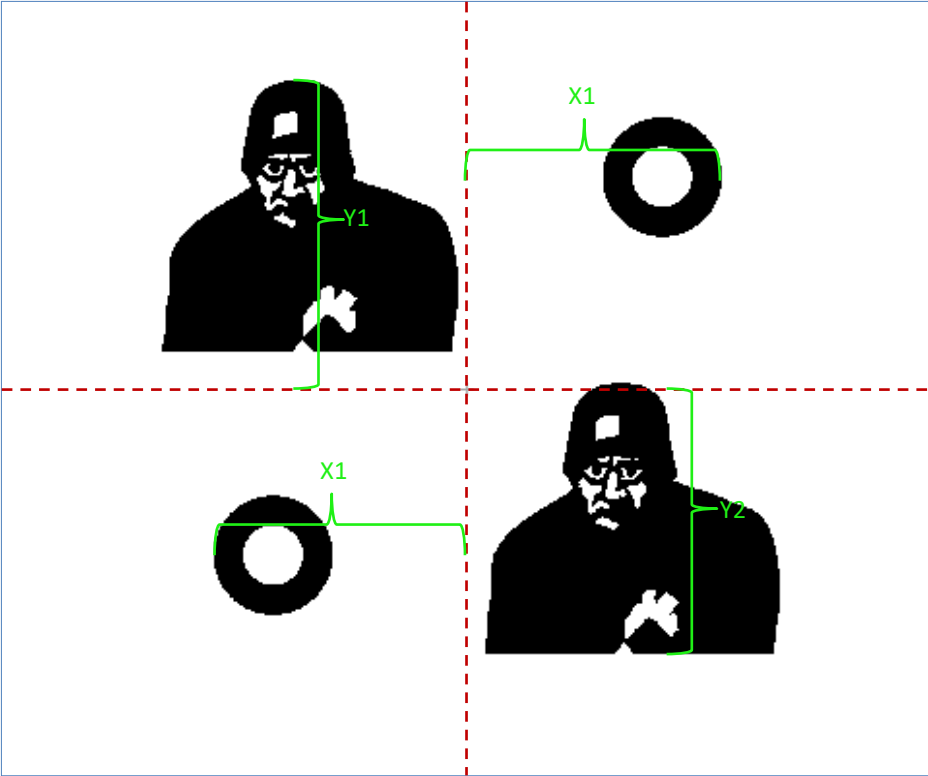

Diameter (mm)	Value

X1	426 mm	X2	424 mm
Y1	514 mm	Y2	445 mm

Zoom levels

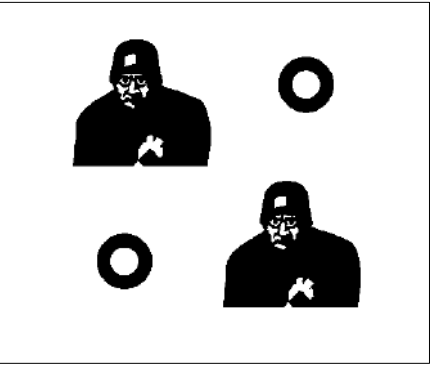

Technical data

Part No	735-0097-97-0050
Size	57 kb
Gauge (default)	8 mm
Aiming mark diameter	
Manufacture	
Manufacture Part No	

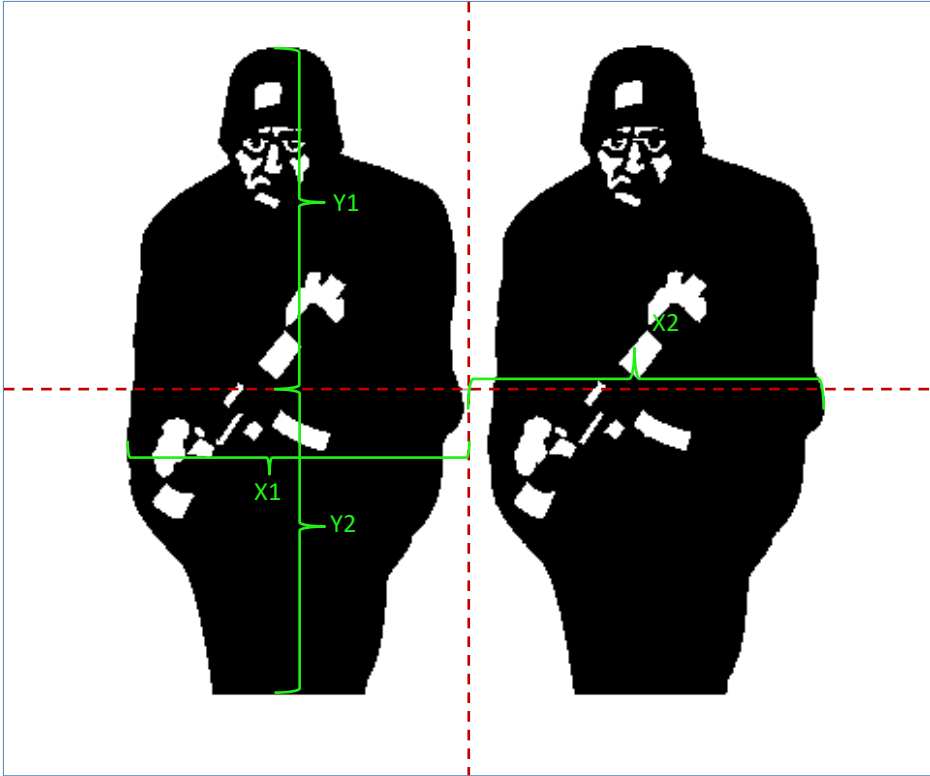

Diameter (mm)	Value

X1	573 mm	X2	594 mm
Y1	569 mm	Y2	514 mm

Zoom levels

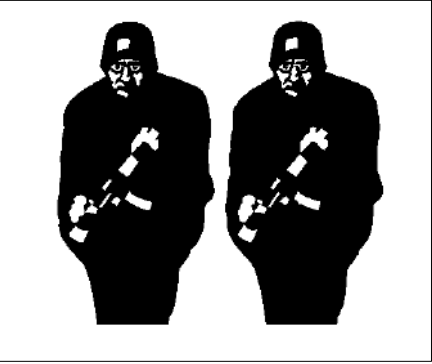

Technical data

Part No	735-0097-97-0051
Size	82 kb
Gauge (default)	8 mm
Aiming mark diameter	
Manufacture	
Manufacture Part No	

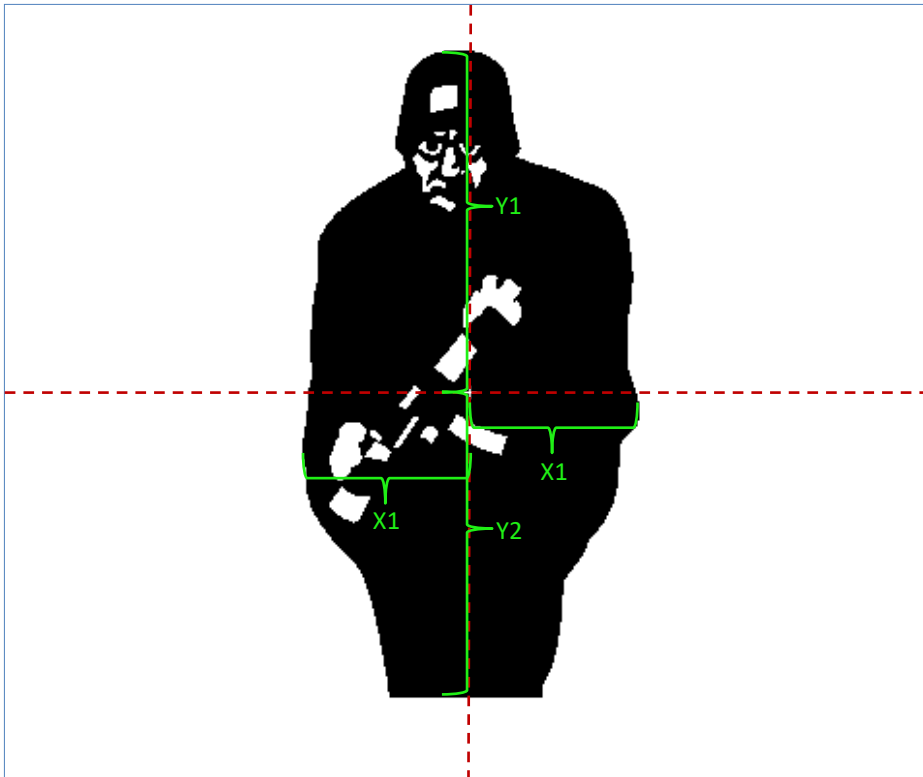

Diameter (mm)	Value

X1	283 mm	X2	279 mm
Y1	569 mm	Y2	514 mm

Zoom levels



Technical data

Part No	735-0097-97-0052
Size	46 kb
Gauge (default)	8 mm
Aiming mark diameter	
Manufacture	
Manufacture Part No	

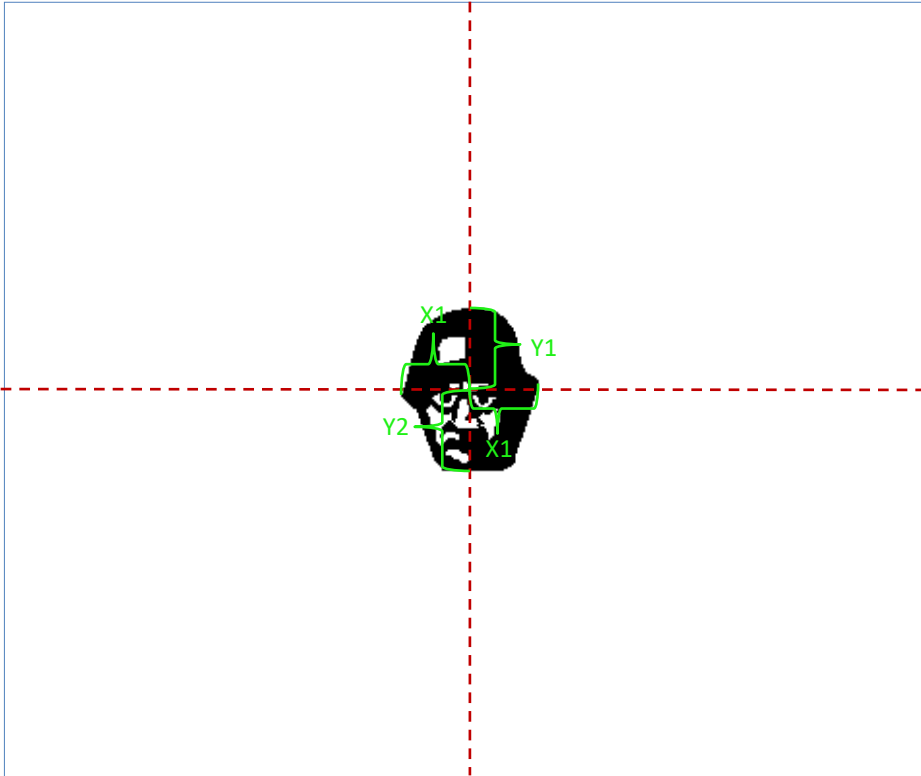

Diameter (mm)	Value

X1	114 mm	X2	116 mm
Y1	135 mm	Y2	137 mm

Zoom levels



Technical data

Part No	735-0097-97-0053
Size	32 kb
Gauge (default)	8 mm
Aiming mark diameter	
Manufacture	
Manufacture Part No	

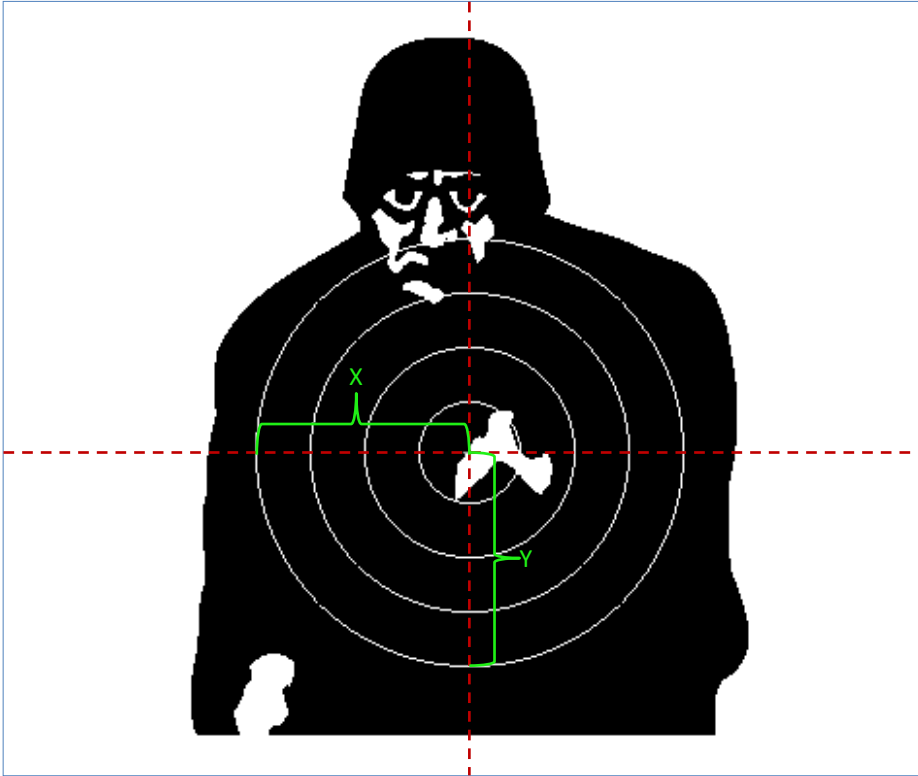

Diameter (mm)	Value
105	5
215	4
325	3
435	2

X	217,5 mm
Y	217,5 mm

Zoom levels



Technical data

Part No	735-0097-97-0054
Size	15 kb
Gauge (default)	8 mm
Aiming mark diameter	435 mm
Manufacture	
Manufacture Part No	

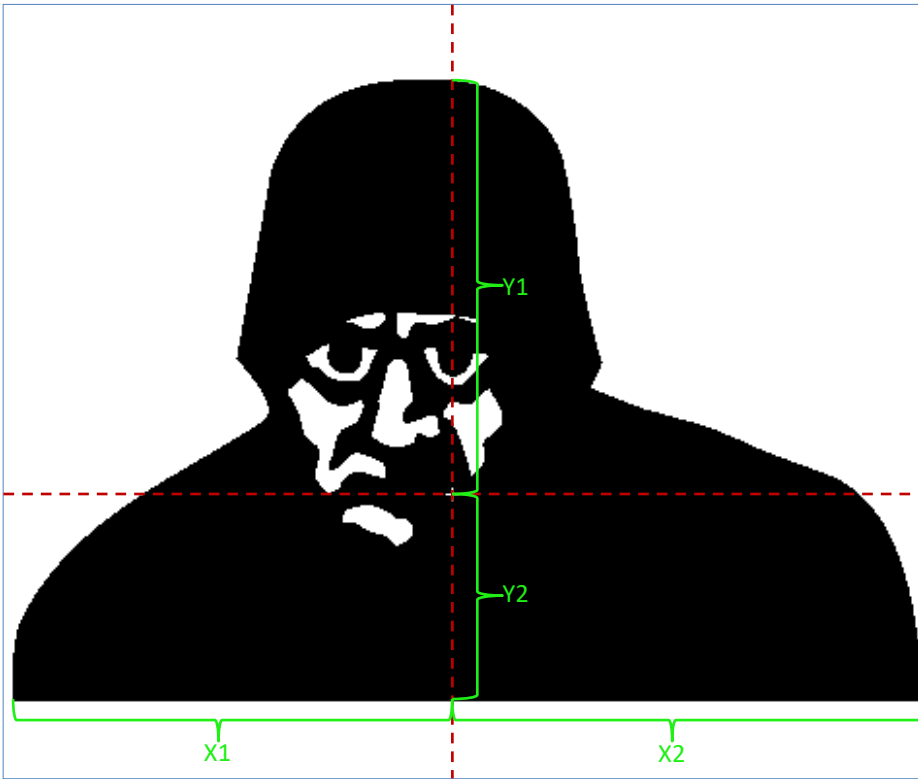

Diameter (mm)	Value

X1	253,035 mm	X2	271,435 mm
Y1	237,405 mm	Y2	118,805 mm

Zoom levels

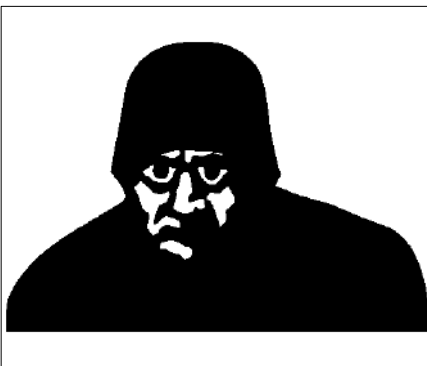

Technical data

Part No	735-0097-97-0055
Size	48 kb
Gauge (default)	8 mm
Aiming mark diameter	
Manufacture	
Manufacture Part No	

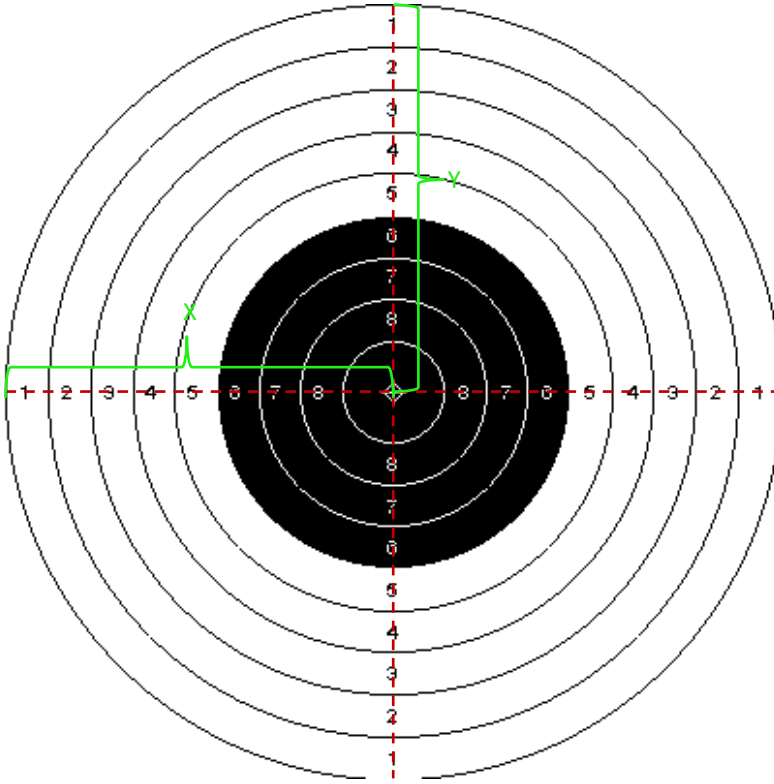

Diameter (mm)	Value
1	*
2	X
11	9
20	8
29	7
38	6
47	5
56	4
65	3
74	2
83	1

X	41,5 mm
Y	41,5 mm

Zoom levels

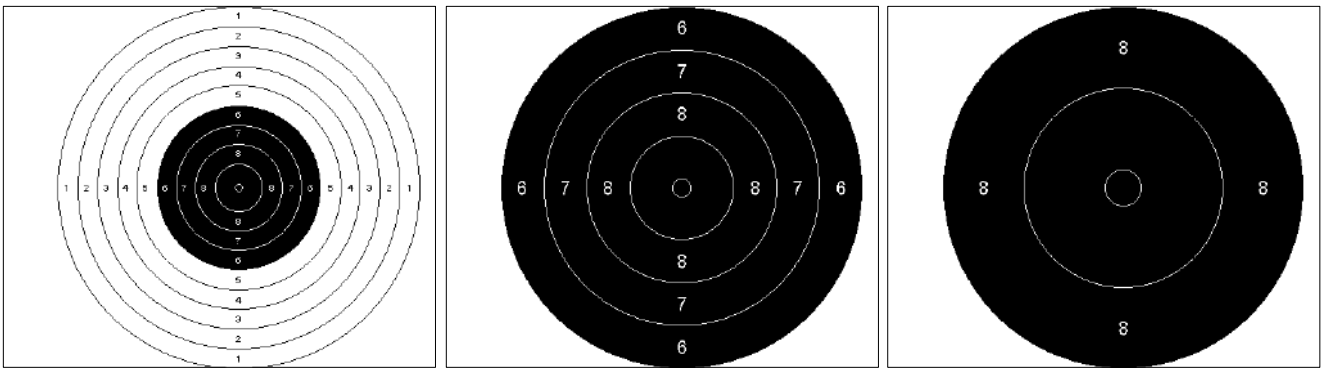

Technical data

Part No	735-0097-97-0056
Size	N/A
Gauge (default)	5,6 mm
Aiming mark diameter	38 mm
Manufacture	
Manufacture Part No	

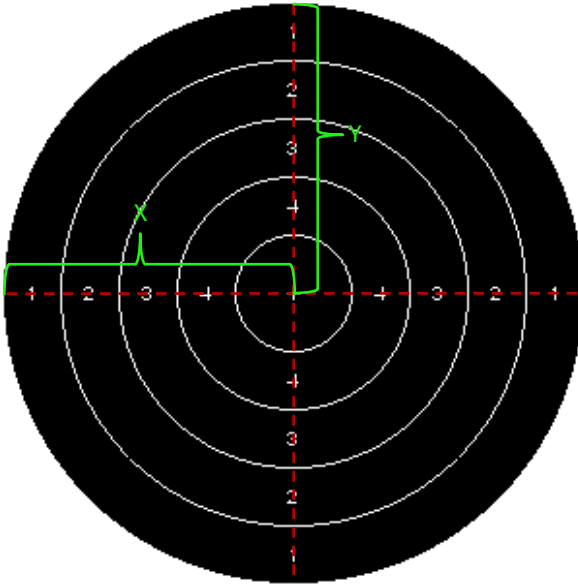

Diameter (mm)	Value
150	5
300	4
450	3
600	2
750	1

X	375 mm
Y	375 mm

Zoom levels

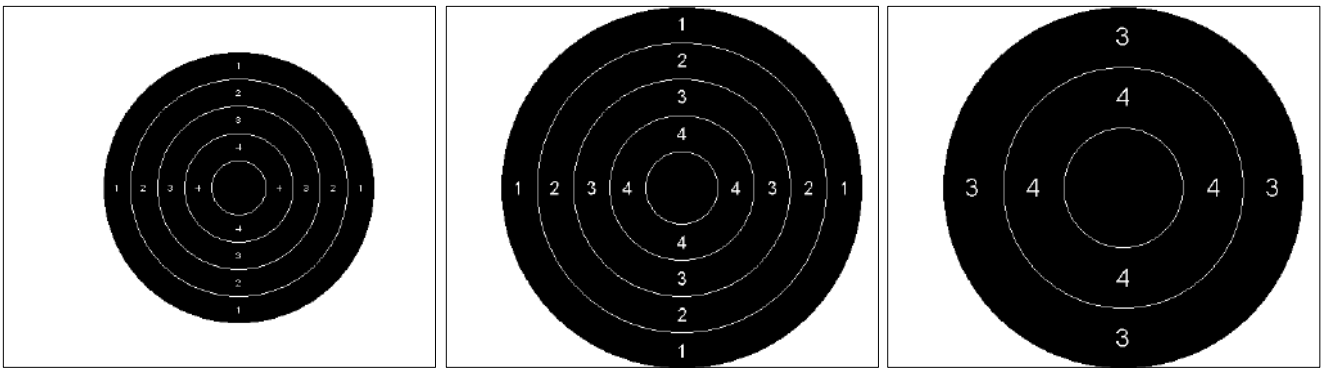

Technical data

Part No	735-0097-97-0057
Size	N/A
Gauge (default)	8 mm
Aiming mark diameter	750 mm
Manufacture	
Manufacture Part No	

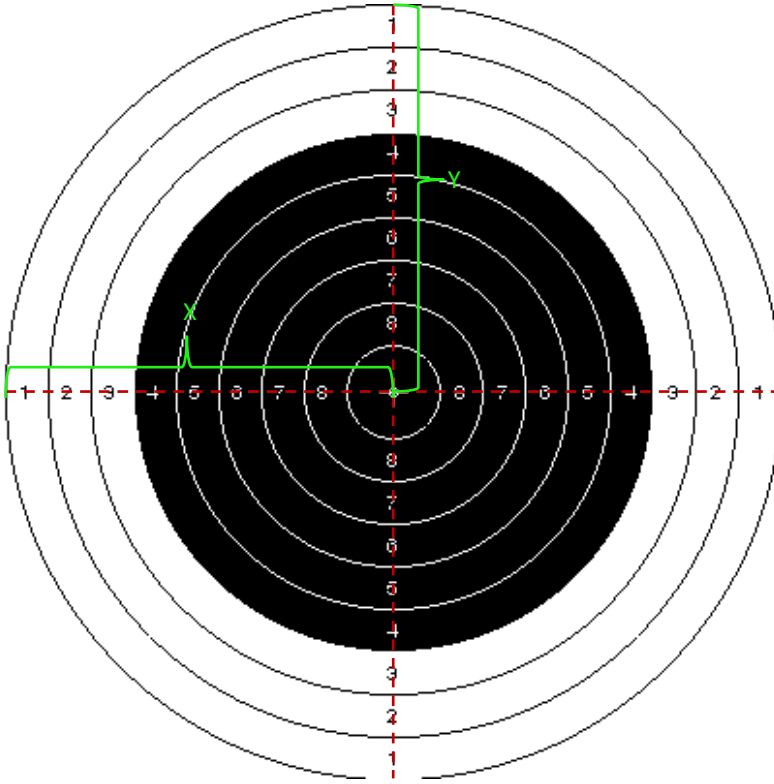

Diameter (mm)	Value
0,300	*
0,500	X
5,5	9
10,5	8
15,5	7
20,5	6
25,5	5
30,5	4
35,5	3
40,5	2
45,5	1

X	22,75 mm
Y	22,75 mm

Zoom levels

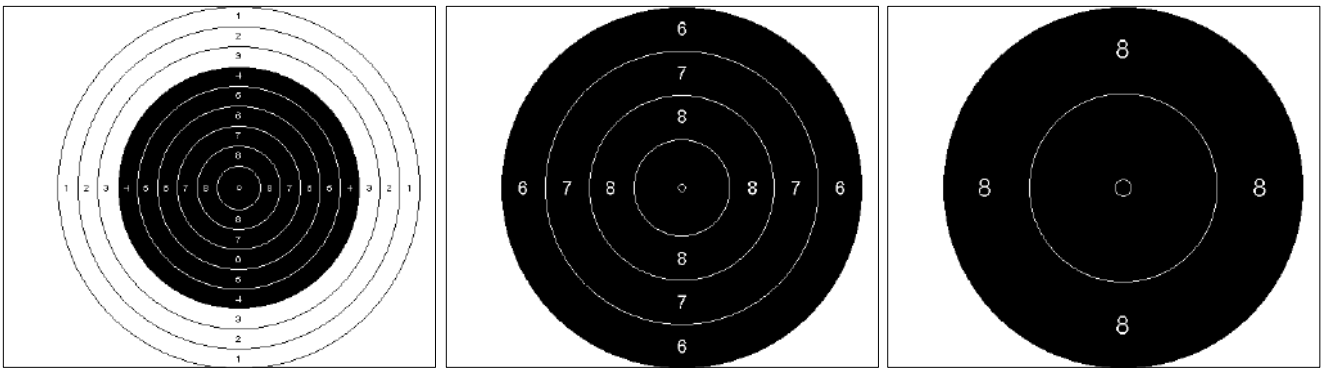

Technical data

Part No	735-0097-97-0058
Size	N/A
Gauge (default)	4,5 mm
Aiming mark diameter	30,5 mm
Manufacture	
Manufacture Part No	

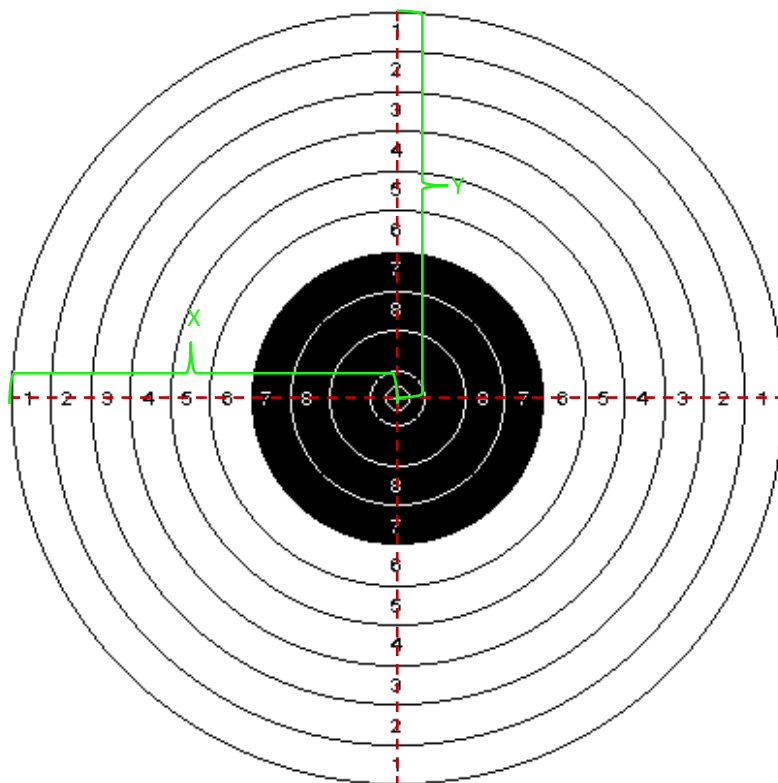

Diameter (mm)	Value
5	*
11,5	X
27,5	9
43,5	8
59,5	7
75,5	6
91,5	5
107,5	4
123,5	3
139,5	2
155,5	1

X	77,75 mm
Y	77,75 mm

Zoom levels

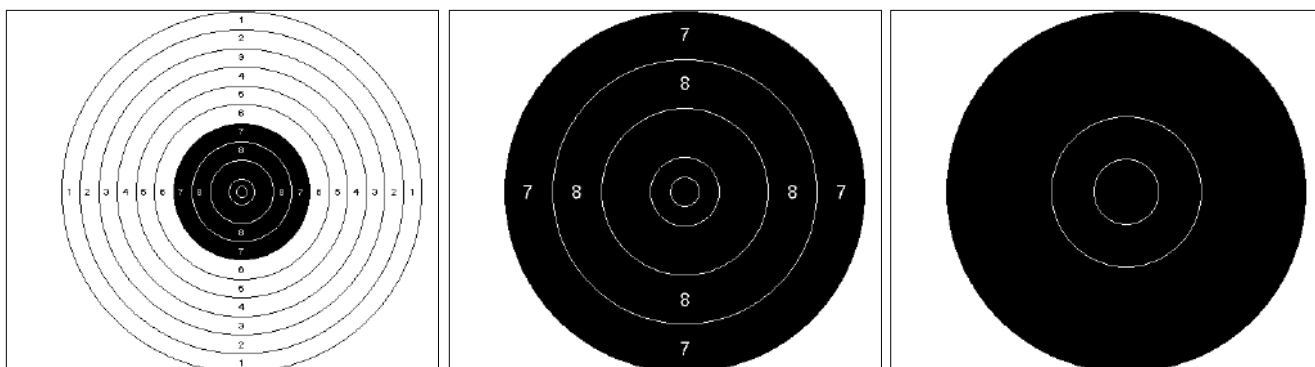

Technical data

Part No	735-0097-97-0059
Size	N/A
Gauge (default)	4,5 mm
Aiming mark diameter	59,5 mm
Manufacture	
Manufacture Part No	

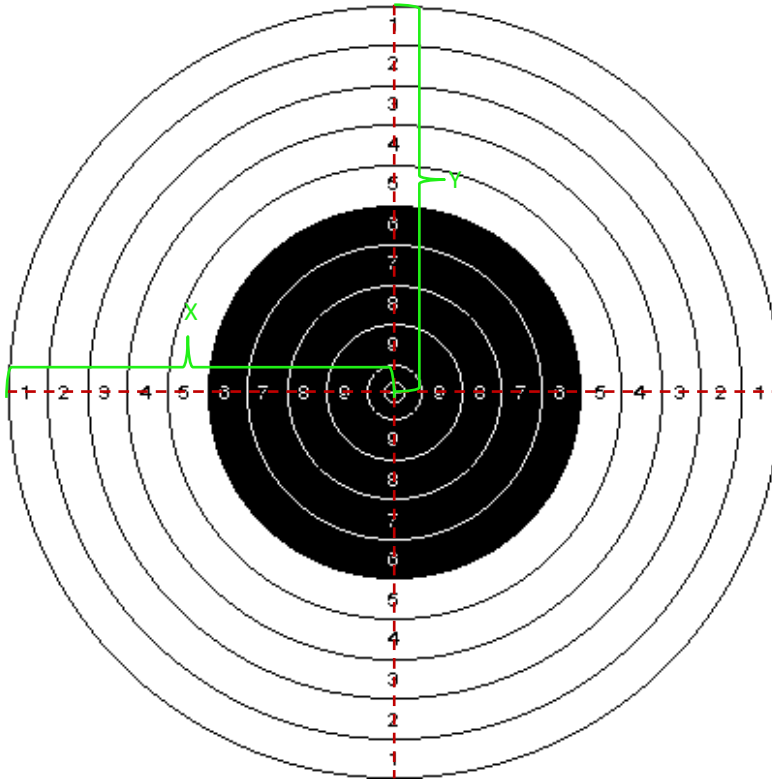

Diameter (mm)	Value
2,4	*
6,4	X
15,4	9
24,4	8
33,4	7
42,4	6
51,4	5
60,4	4
69,4	3
78,4	2
87,4	1

X	43,7 mm
Y	43,7 mm

Zoom levels

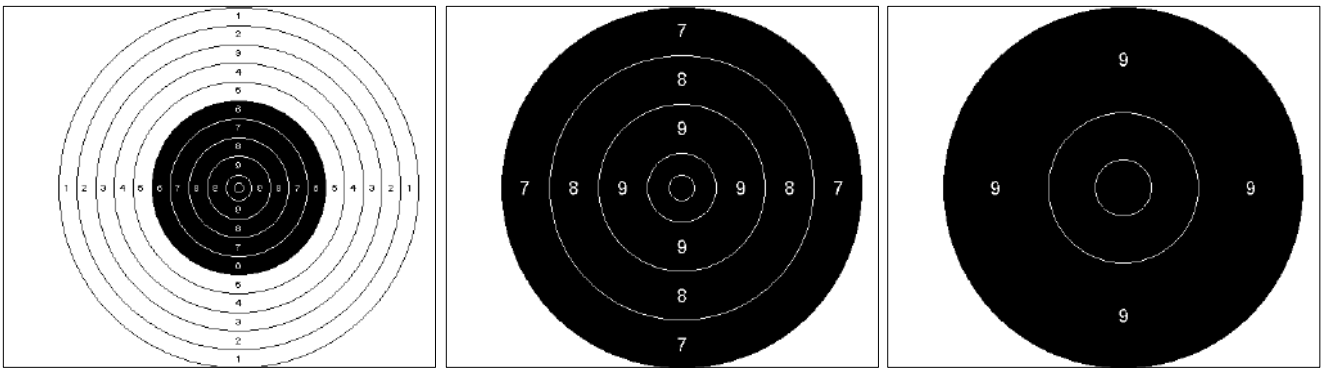

Technical data

Part No	735-0097-97-0060
Size	N/A
Gauge (default)	1,2 mm
Aiming mark diameter	42,4 mm
Manufacture	
Manufacture Part No	

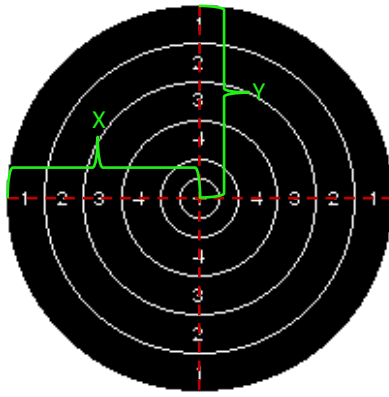

Diameter (mm)	Value
29,6	*
59	5
115	4
171	3
228	2
285	1

X	142,5 mm
Y	142,5 mm

Zoom levels

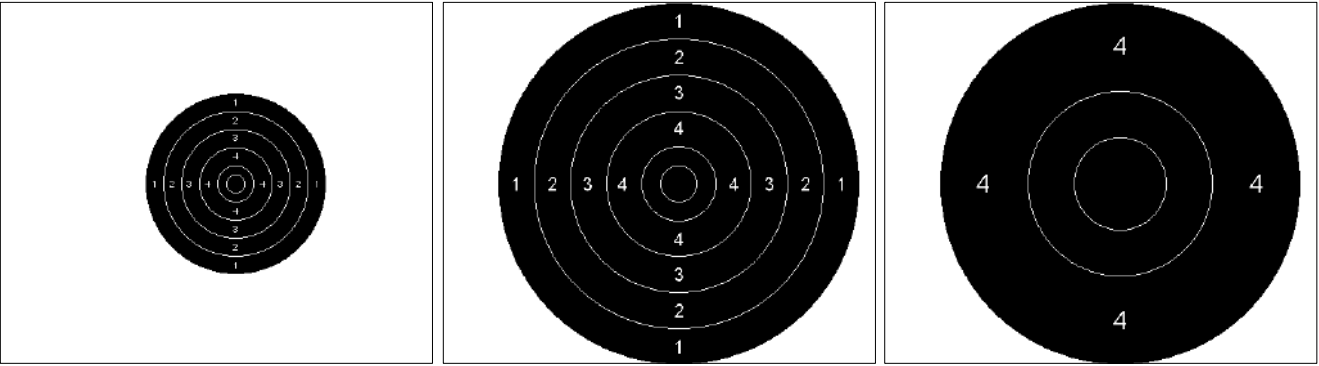

Technical data

Part No	735-0097-97-0061
Size	N/A
Gauge (default)	8 mm
Aiming mark diameter	285 mm
Manufacture	
Manufacture Part No	

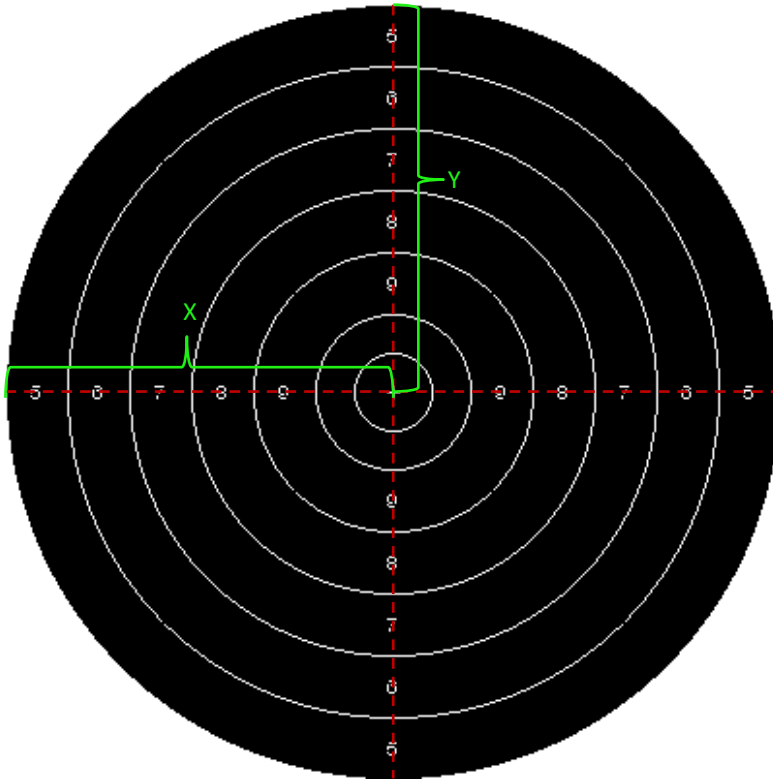

Diameter (mm)	Value
50	*
100	X
180	9
260	8
340	7
420	6
500	5

X	250 mm
Y	250 mm

Zoom levels

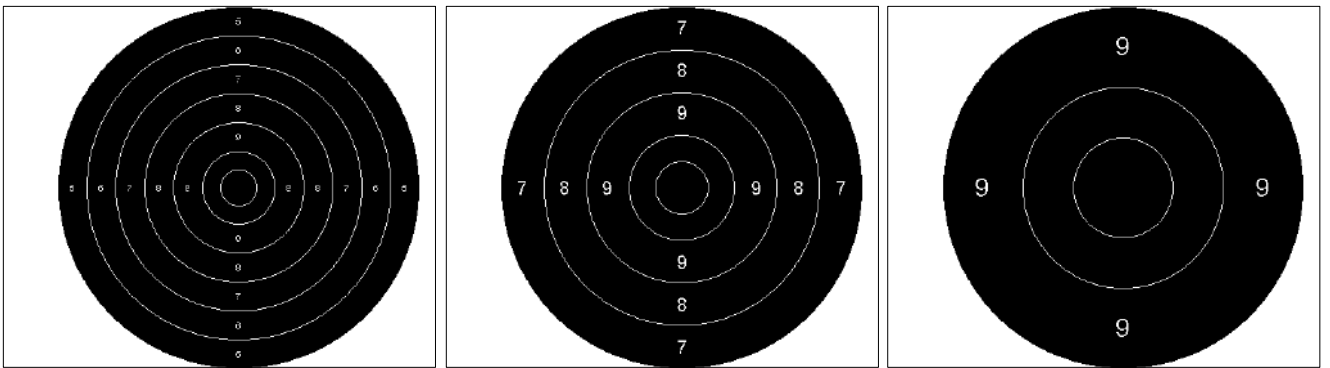

Technical data

Part No	735-0097-97-0062
Size	N/A
Gauge (default)	5,6 mm
Aiming mark diameter	500 mm
Manufacture	
Manufacture Part No	

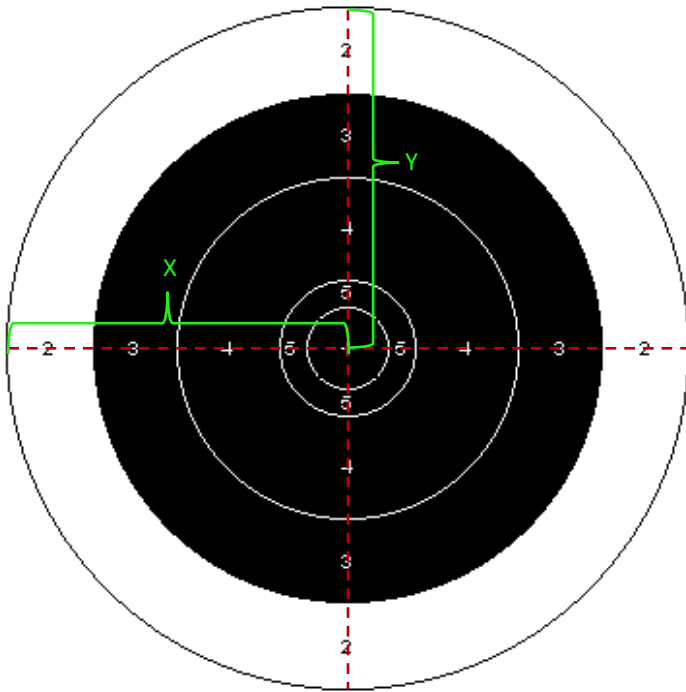

Diameter (mm)	Value
180	V
266	5
660	4
990	3
1320	2

X	660 mm
Y	660 mm

Zoom levels

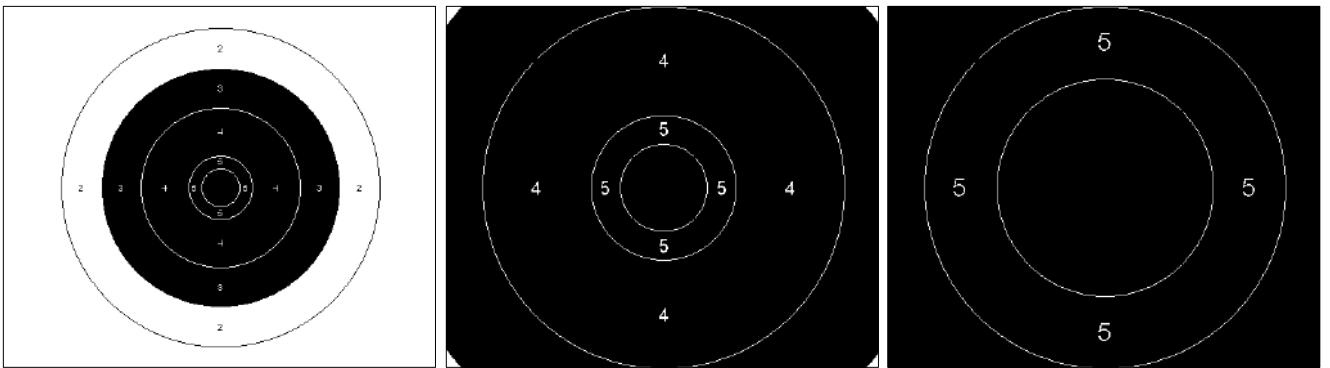

Technical data

Part No	735-0097-97-0063
Size	11 kb
Gauge (default)	8 mm
Aiming mark diameter	990 mm
Manufacture	
Manufacture Part No	

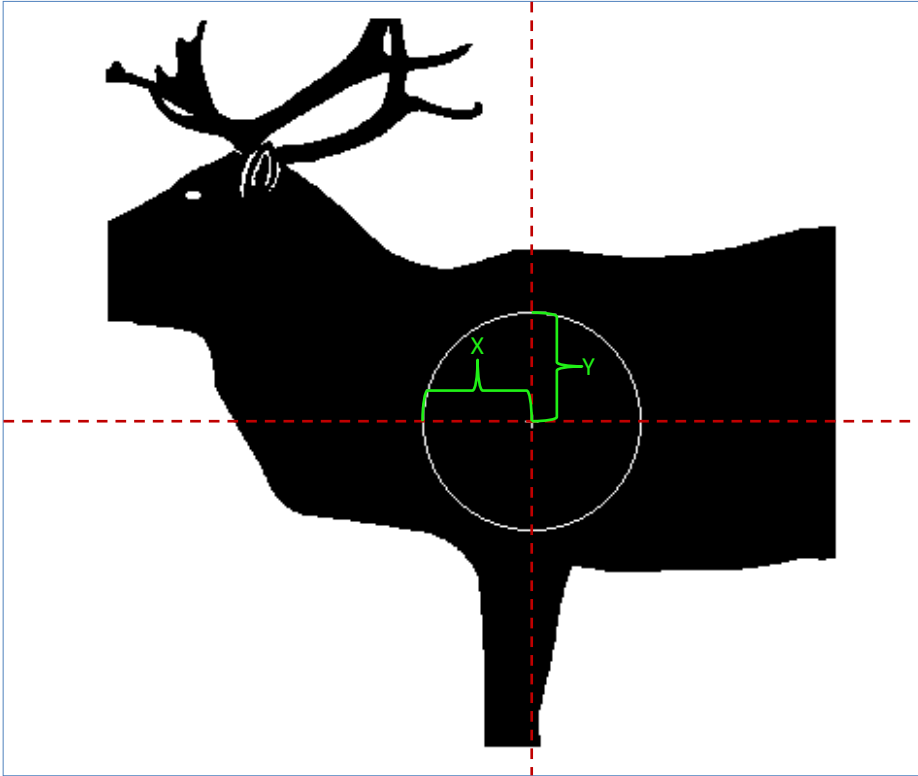

Diameter (mm)	Value
300	X

X	150 mm
Y	150 mm

Zoom levels

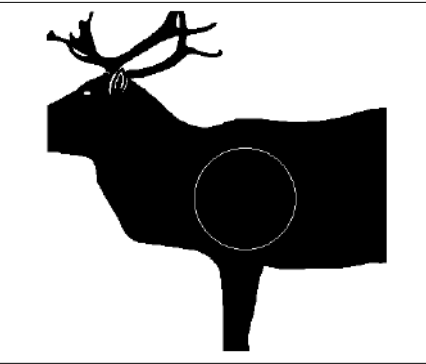

Technical data

Part No	735-0097-97-0064
Size	17 kb
Gauge (default)	8 mm
Aiming mark diameter	300 mm
Manufacture	
Manufacture Part No	

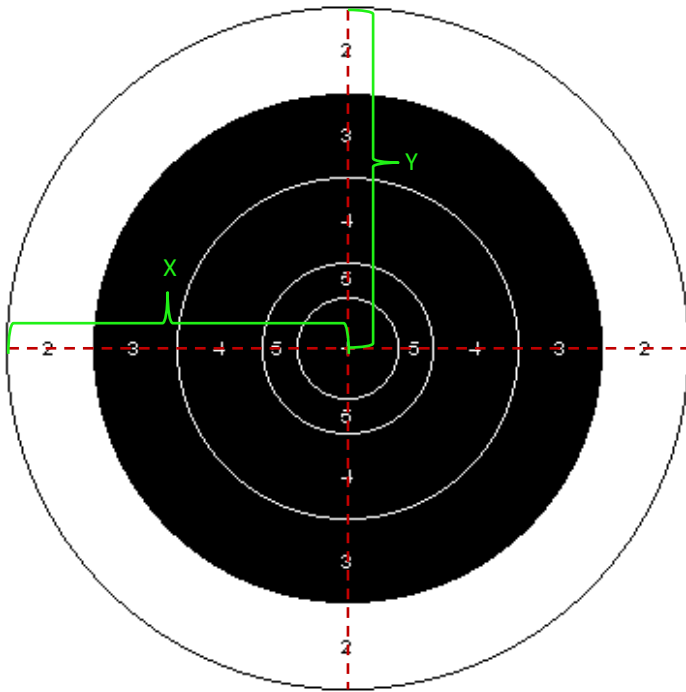

Diameter (mm)	Value
198	V
330	5
660	4
990	3
1320	2

X	660 mm
Y	660 mm

Zoom levels



Technical data

Part No	735-0097-97-0065
Size	11 kb
Gauge (default)	8 mm
Aiming mark diameter	990 mm
Manufacture	
Manufacture Part No	

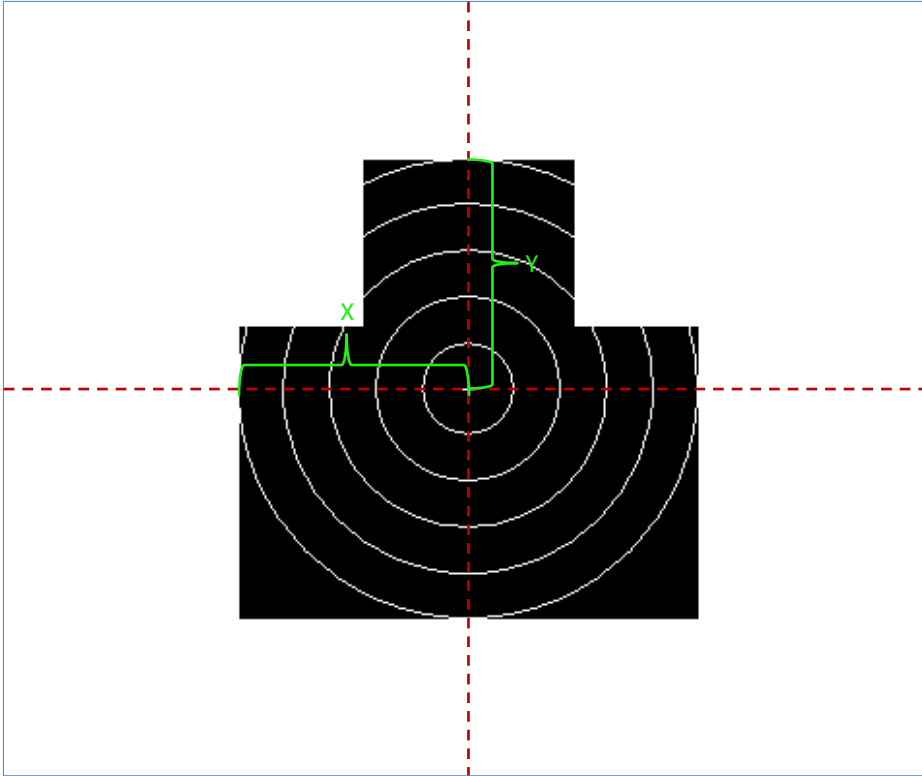

Diameter (mm)	Value
100	5
200	4
300	3
400	2
500	1

X	250 mm
Y	250 mm

Zoom levels

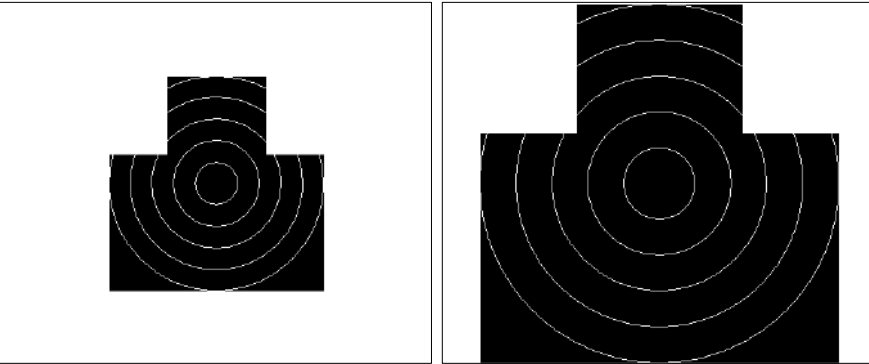

Technical data

Part No	735-0097-97-0066
Size	108 kb
Gauge (default)	8 mm
Aiming mark diameter	500 mm
Manufacture	
Manufacture Part No	

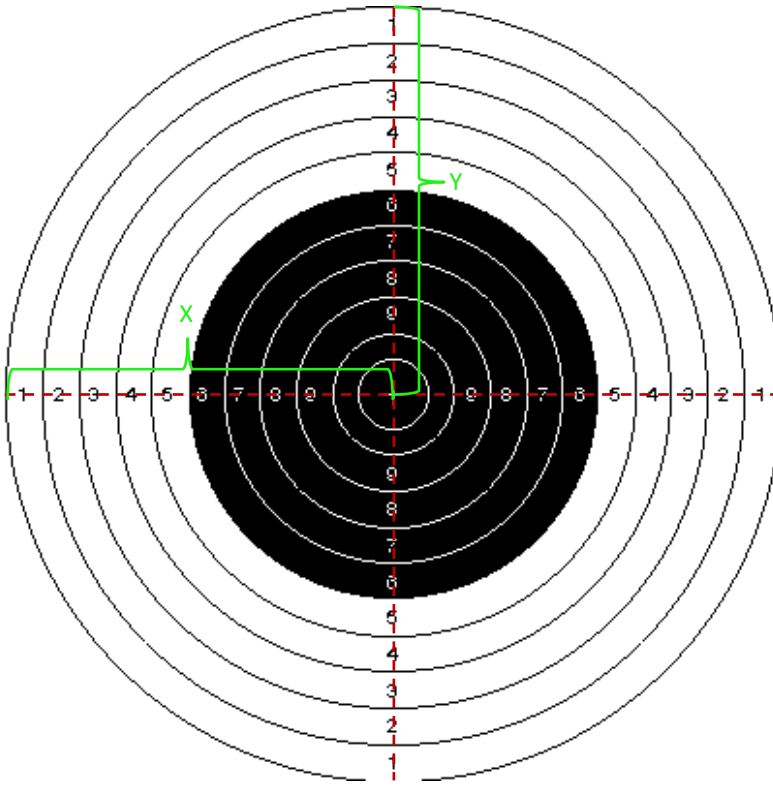

Diameter (mm)	Value
7,5	*
12,75	X
20,25	9
27,75	8
35,25	7
42,75	6
50,25	5
57,75	4
65,25	3
72,75	2
80,25	1

X	40,125 mm
Y	40,125 mm

Zoom levels

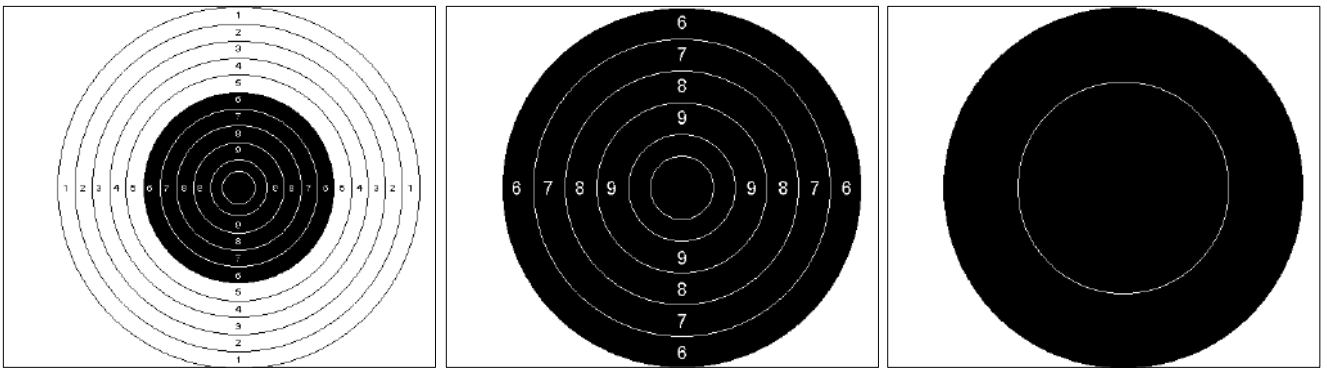

Technical data

Part No	735-0097-97-0067
Size	N/A
Gauge (default)	4,5 mm
Aiming mark diameter	42,75 mm
Manufacture	
Manufacture Part No	

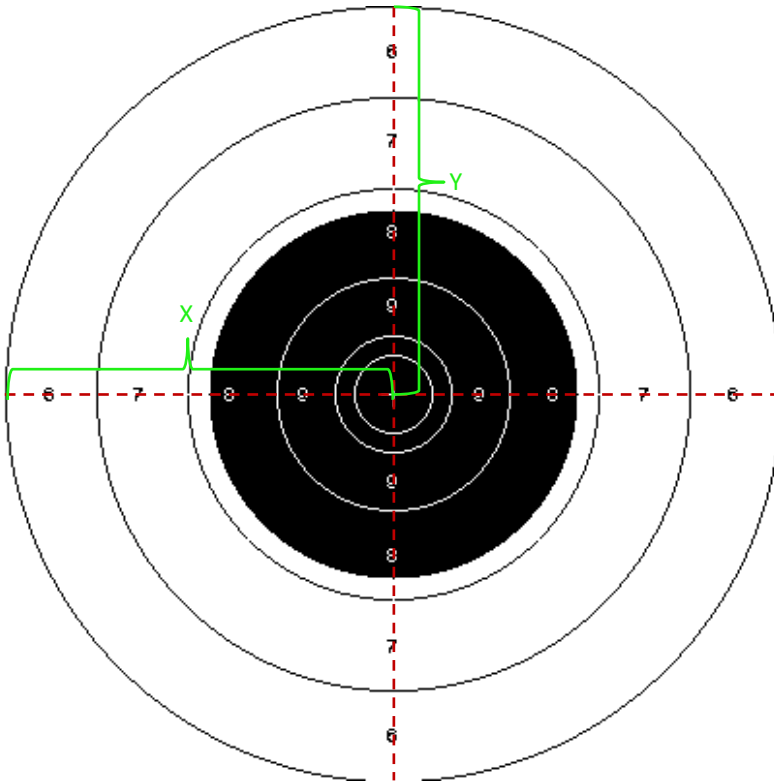

Diameter (mm)	Value
9	*
13	X
26	9
46	8
66	7
86	6

X	43 mm
Y	43 mm

Zoom levels

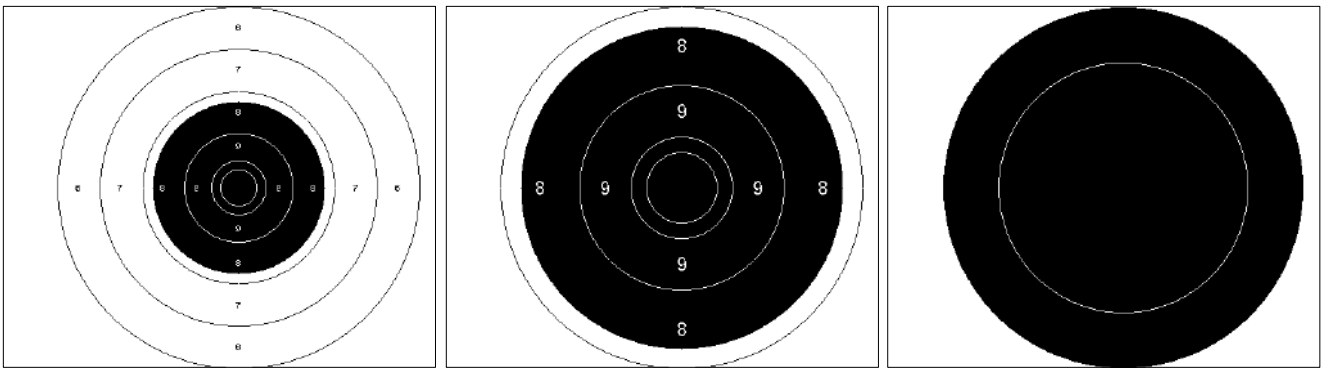

Technical data

Part No	735-0097-97-0068
Size	N/A
Gauge (default)	5,6 mm
Aiming mark diameter	41 mm
Manufacture	
Manufacture Part No	

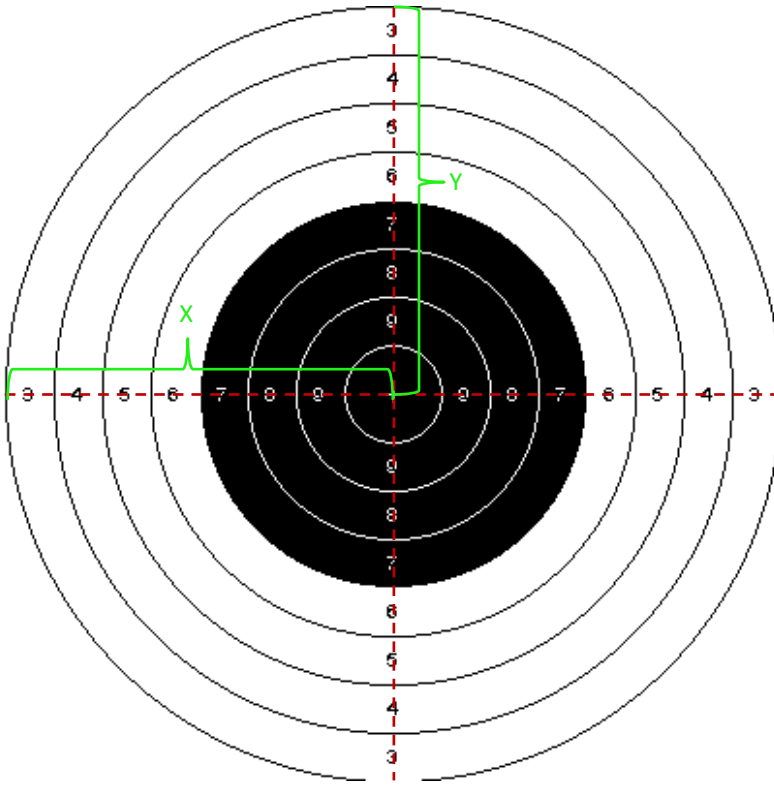

Diameter (mm)	Value
25	X
50	9
75	8
100	7
125	6
150	5
175	4
200	3

X	100 mm
Y	100 mm

Zoom levels

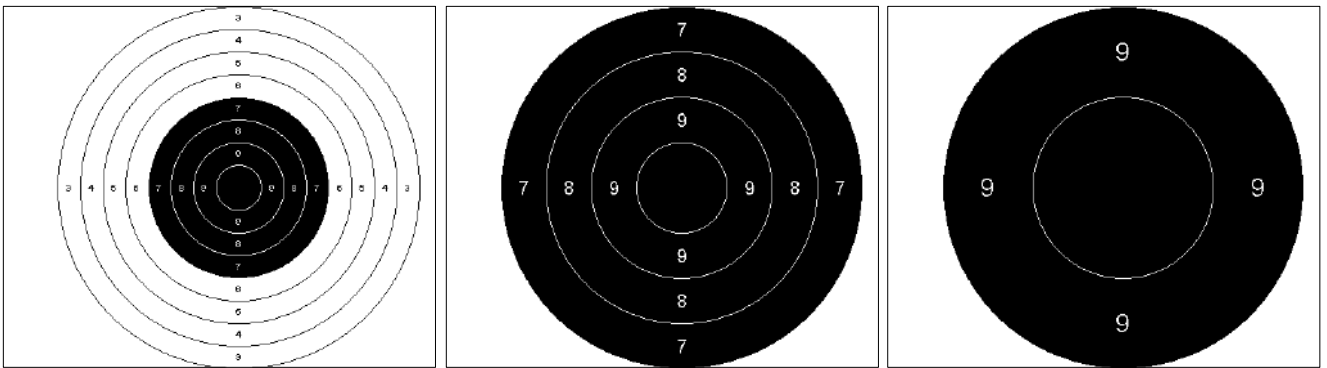

Technical data

Part No	735-0097-97-0069
Size	N/A
Gauge (default)	4,5 mm
Aiming mark diameter	100 mm
Manufacture	
Manufacture Part No	

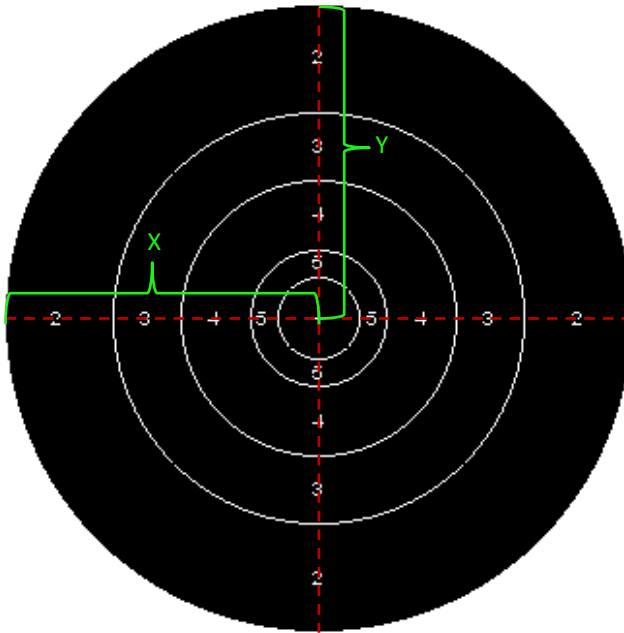

Diameter (mm)	Value
53,3	V
88,9	5
177,8	4
266,7	3
406,4	2

X	203,2 mm
Y	203,2 mm

Zoom levels

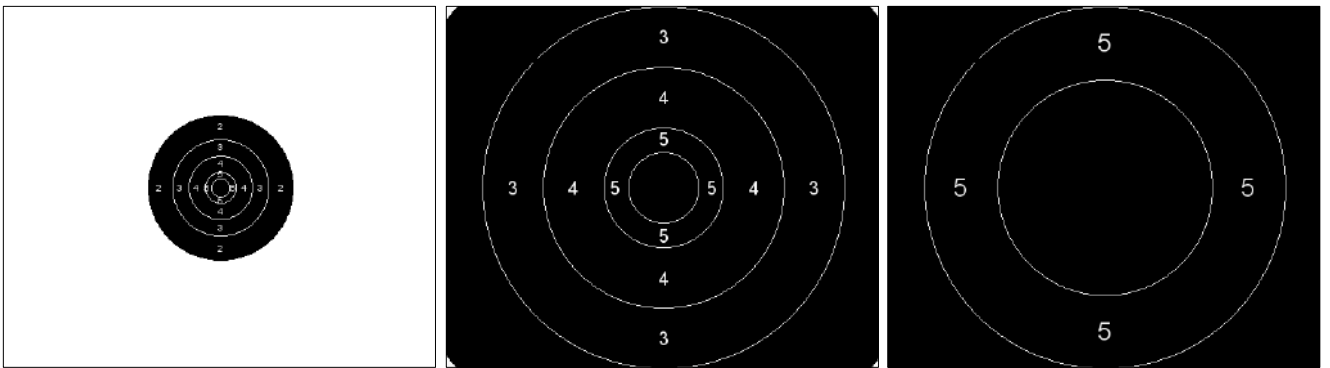

Technical data

Part No	735-0097-97-0070
Size	11 kB
Gauge (default)	8 mm
Aiming mark diameter	406,4 mm
Manufacture	
Manufacture Part No	

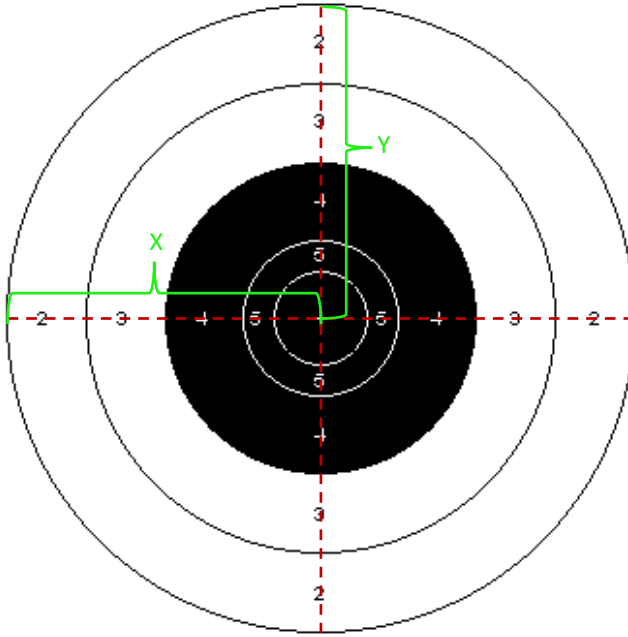

Diameter (mm)	Value
365,8	V
609,6	5
1219	4
1828,8	3
2438,4	2

X	1219,2 mm
Y	1219,2 mm

Zoom levels

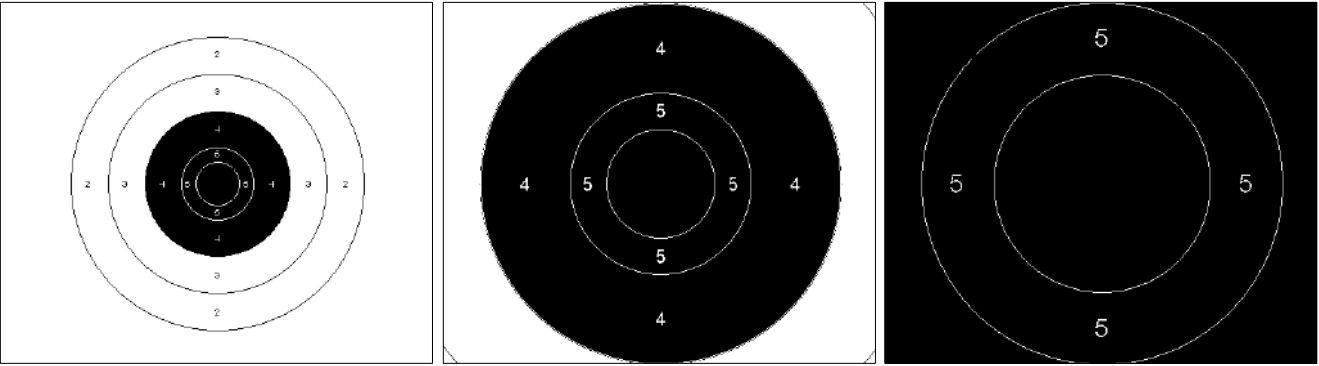

Technical data

Part No	735-0097-97-0071
Size	11 kb
Gauge (default)	8 mm
Aiming mark diameter	1219,2 mm
Manufacture	
Manufacture Part No	

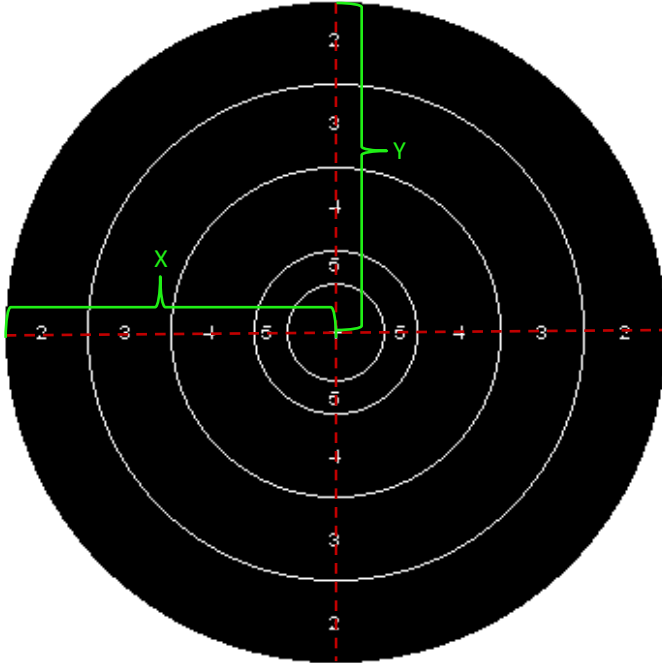

Diameter (mm)	Value
83,8	V
139,7	5
279,4	4
419,1	3
558,8	2

X	279,4 mm
Y	279,4 mm

Zoom levels



Technical data

Part No	735-0097-97-0072
Size	11 kb
Gauge (default)	8 mm
Aiming mark diameter	558,8 mm
Manufacture	
Manufacture Part No	

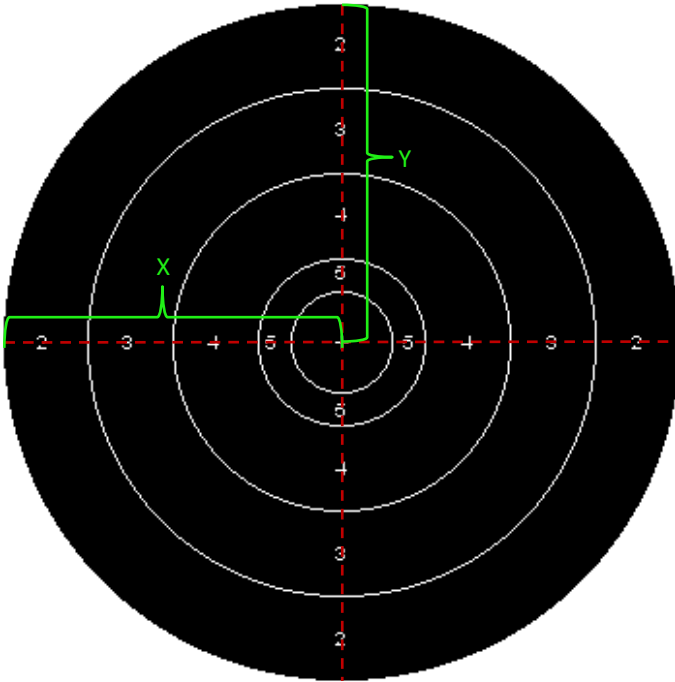

Diameter (mm)	Value
121,9	V
203,2	5
406,4	4
609,6	3
812,8	2

X	406,4 mm
Y	406,4 mm

Zoom levels



Technical data

Part No	735-0097-97-0073
Size	11 kb
Gauge (default)	8 mm
Aiming mark diameter	812,8 mm
Manufacture	
Manufacture Part No	

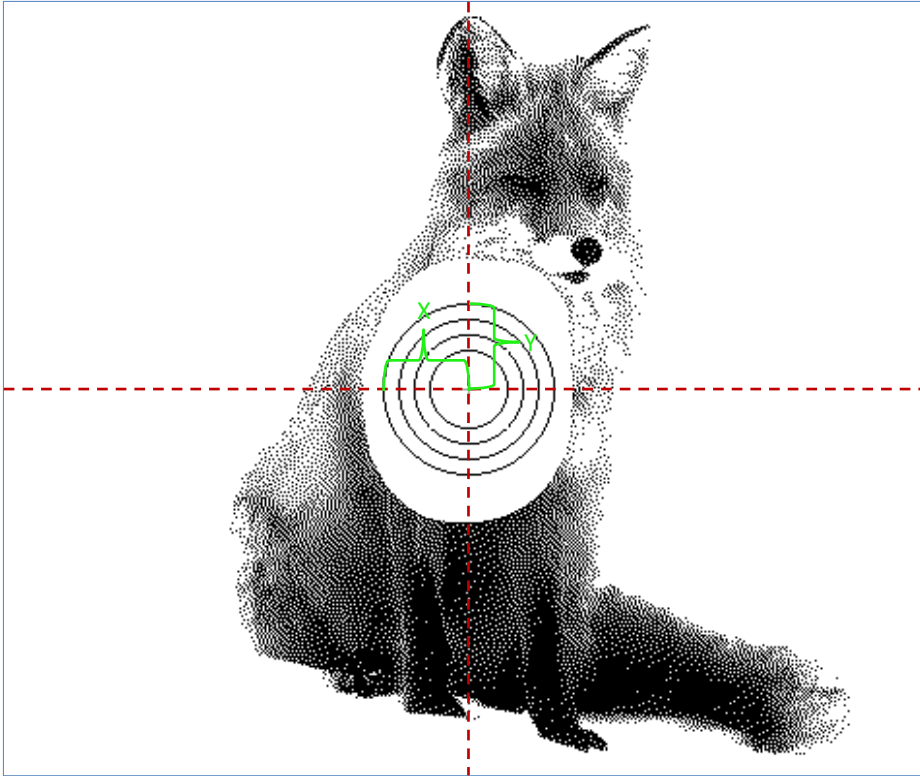

Diameter (mm)	Value
65	5
90	4
115	3
140	2

X	70 mm
Y	70 mm

Zoom levels

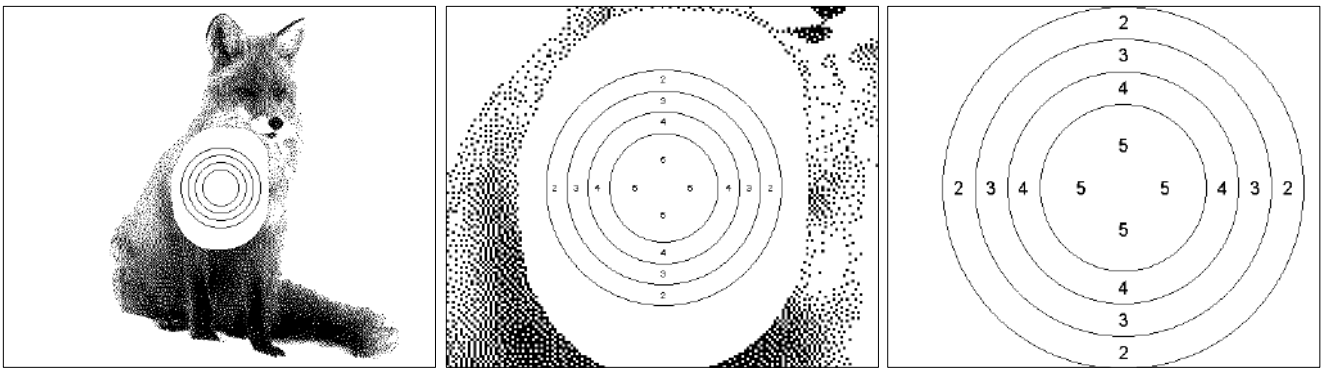

Technical data

Part No	735-0097-97-0074
Size	52 kb
Gauge (default)	8 mm
Aiming mark diameter	140 mm
Manufacture	BEO
Manufacture Part No	BEO-Rev-2

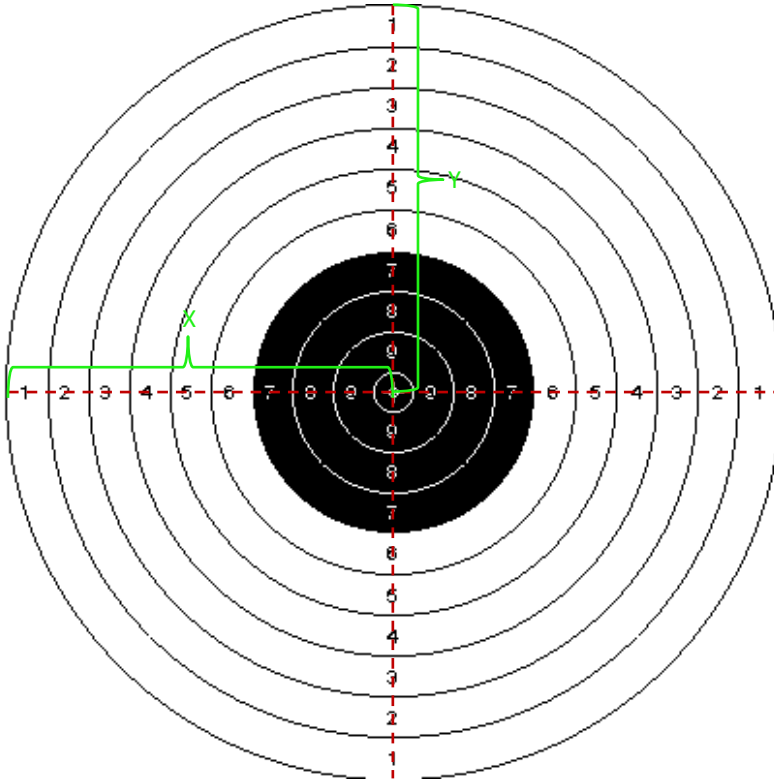

Diameter (mm)	Value
1	*
4,8	X
14,8	9
24,8	8
34,8	7
44,8	6
54,8	5
64,8	4
74,8	3
84,8	2
94,8	1

X	47,4 mm
Y	47,4 mm

Zoom levels

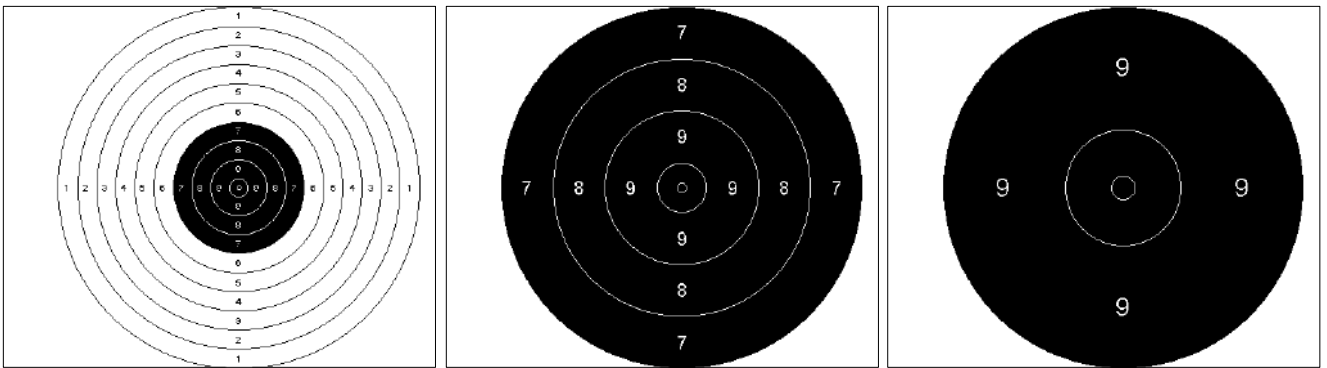

Technical data

Part No	735-0097-97-0075
Size	N/A
Gauge (default)	5,6 mm
Aiming mark diameter	34,8 mm
Manufacture	
Manufacture Part No	

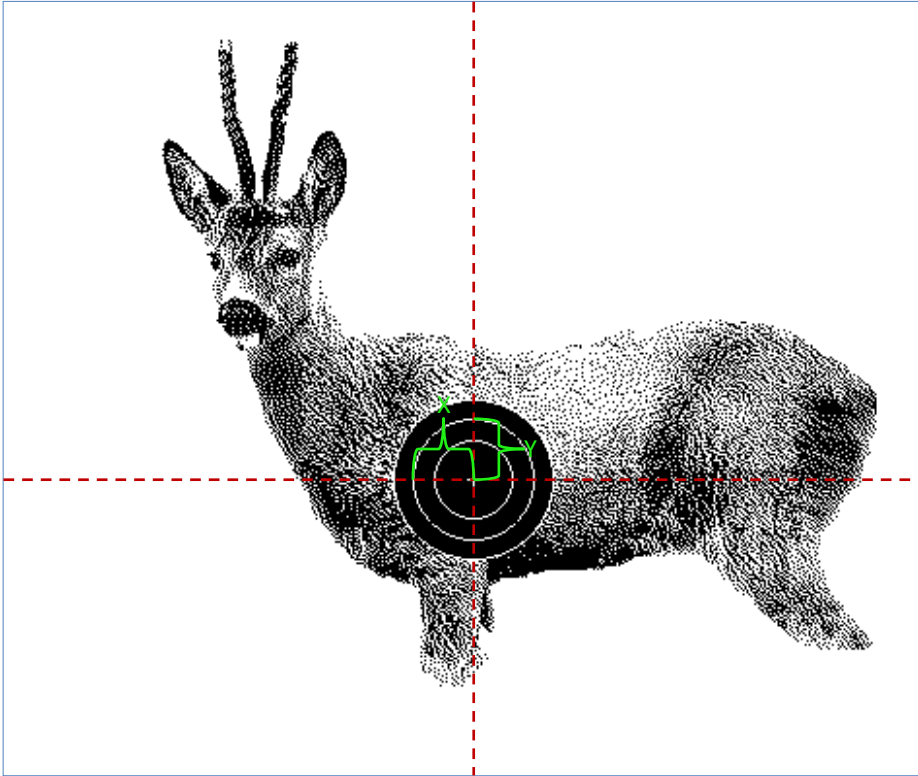

Diameter (mm)	Value
100	X
150	9
200	8

X	100 mm
Y	100 mm

Zoom levels

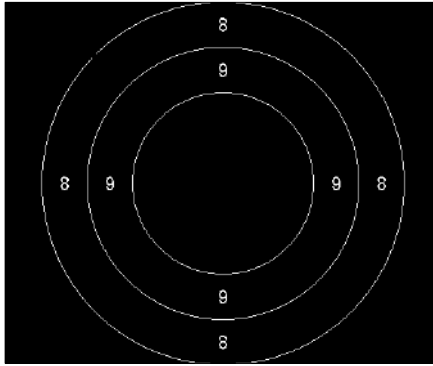
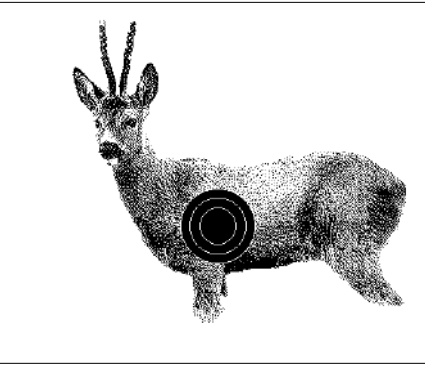

Technical data

Part No	735-0097-97-0076
Size	38 kb
Gauge (default)	8 mm
Aiming mark diameter	200 mm
Manufacture	
Manufacture Part No	

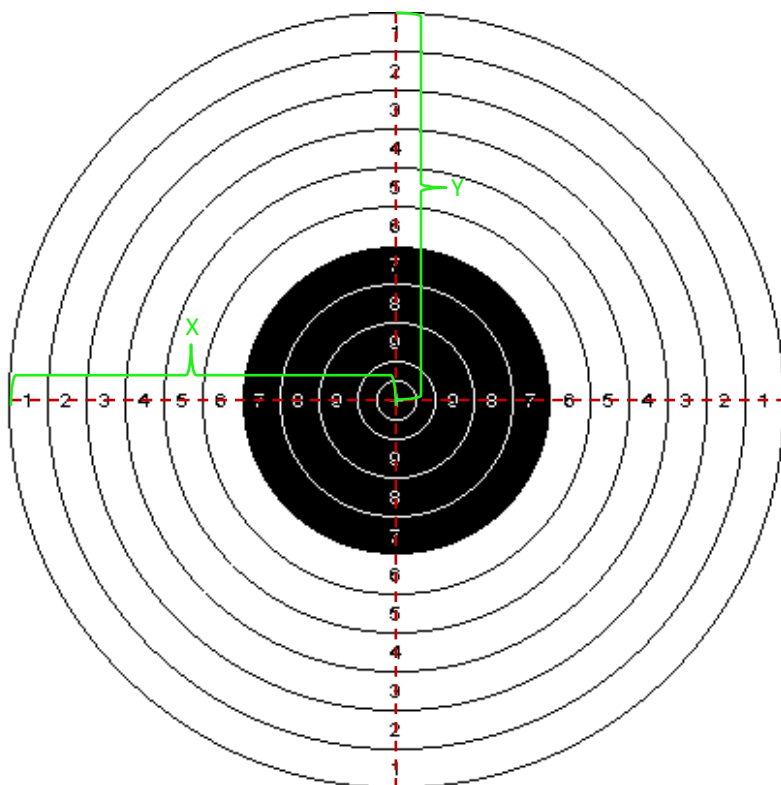

Diameter (mm)	Value
25	*
50	X
100	9
150	8
200	7
250	6
300	5
350	4
400	3
450	2
500	1

X	250 mm
Y	250 mm

Zoom levels

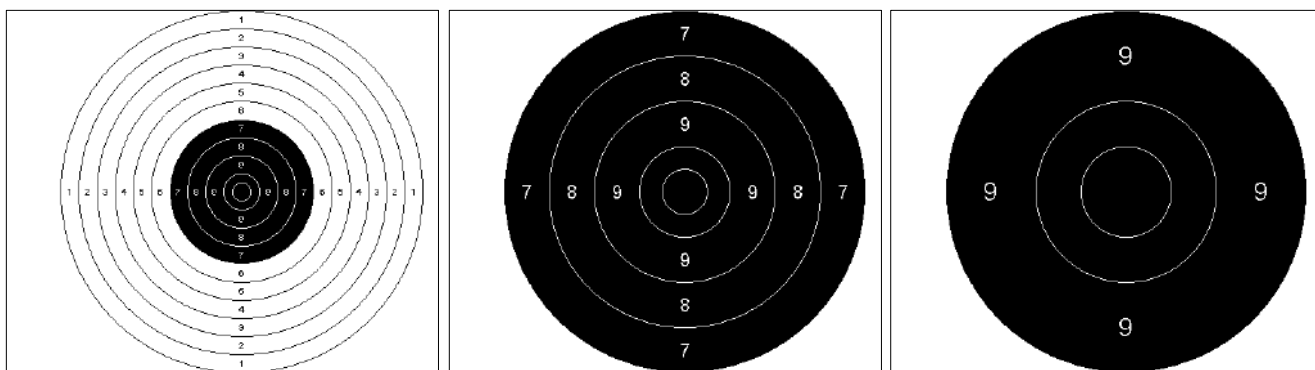

Technical data

Part No	735-0097-97-0077
Size	N/A
Gauge (default)	9,65 mm
Aiming mark diameter	200 mm
Manufacture	
Manufacture Part No	

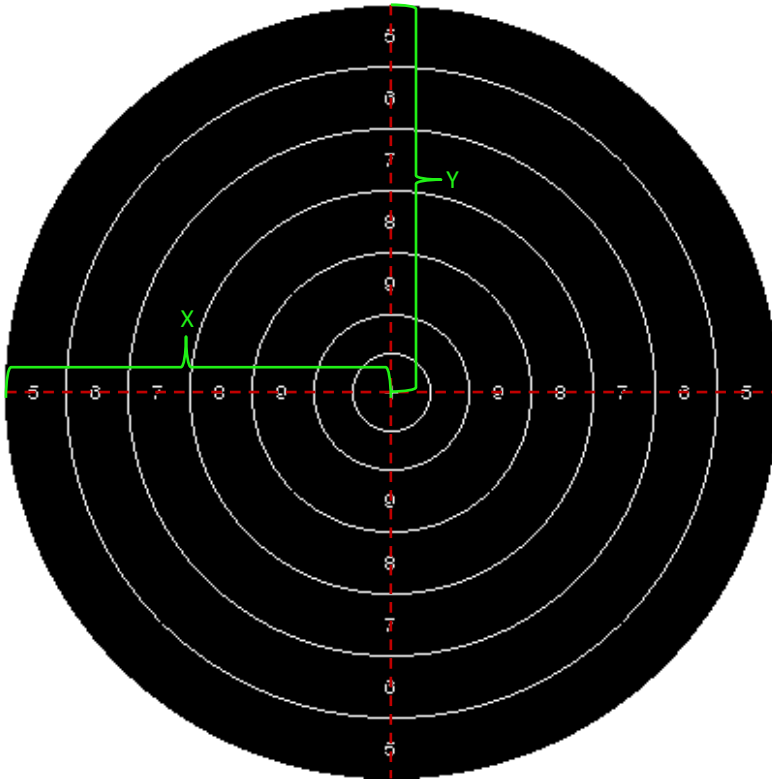

Diameter (mm)	Value
50	*
100	X
180	9
260	8
340	7
420	6
500	5

X	250 mm
Y	250 mm

Zoom levels

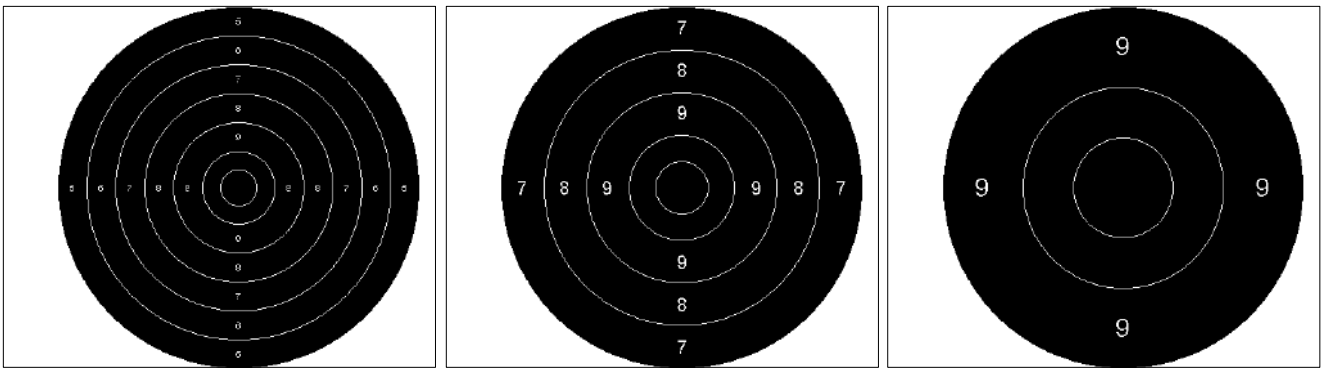

Technical data

Part No	735-0097-97-0078
Size	N/A
Gauge (default)	9,650 mm
Aiming mark diameter	500 mm
Manufacture	
Manufacture Part No	

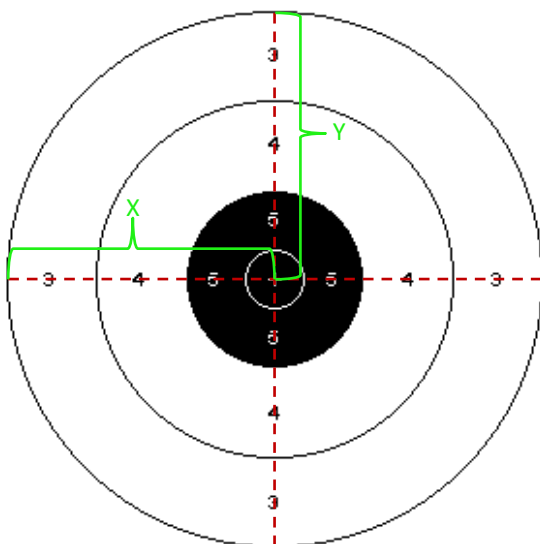

Diameter (mm)	Value
50	V
300	5
600	4
900	3

X	450 mm
Y	450 mm

Zoom levels

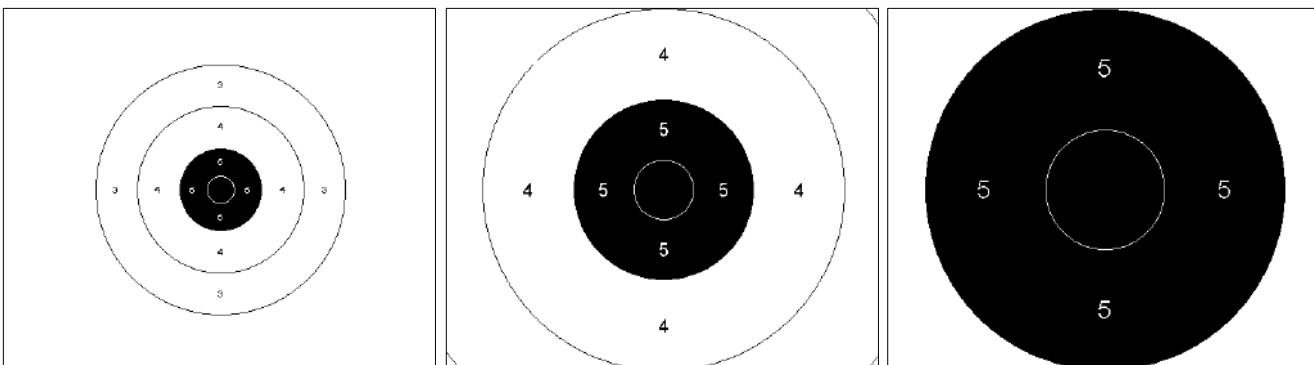

Technical data

Part No	735-0097-97-0079
Size	2 kb
Gauge (default)	8 mm
Aiming mark diameter	300 mm
Manufacture	
Manufacture Part No	

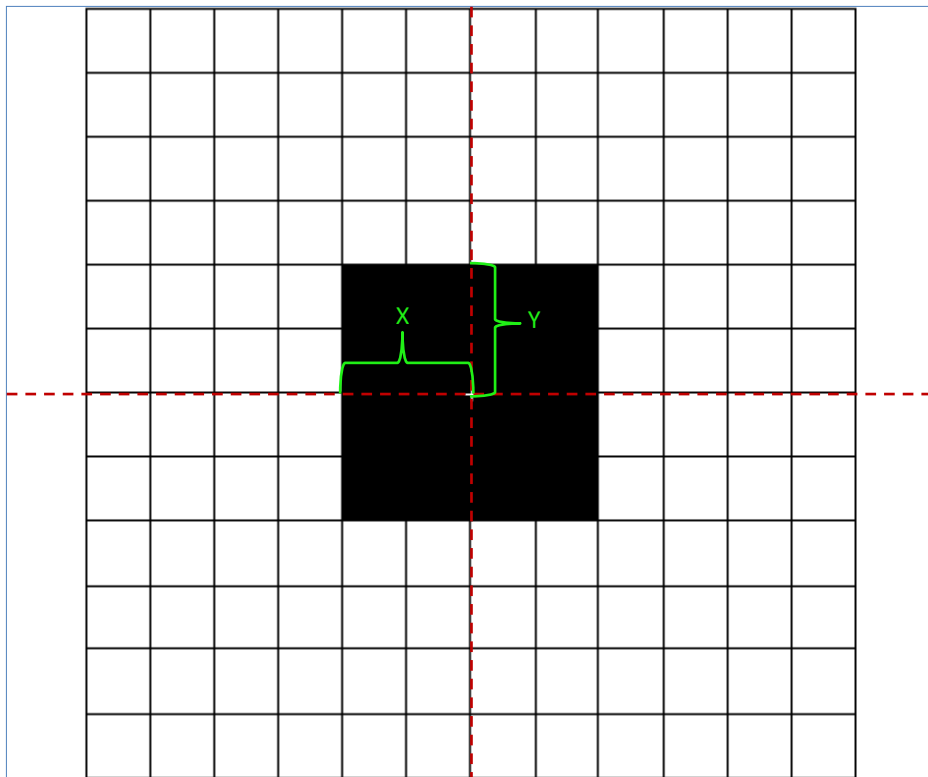

Diameter (mm)	Value

X	200 mm
Y	200 mm

Zoom levels

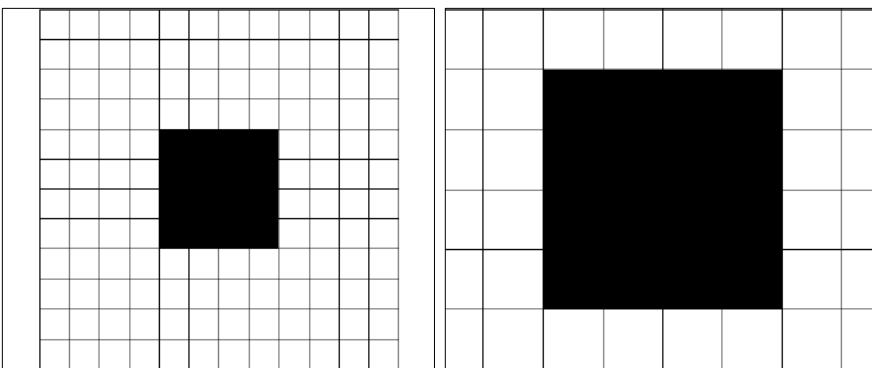

Technical data

Part No	735-0097-97-0080
Size	44 kb
Gauge (default)	8 mm
Aiming mark diameter	
Manufacture	
Manufacture Part No	

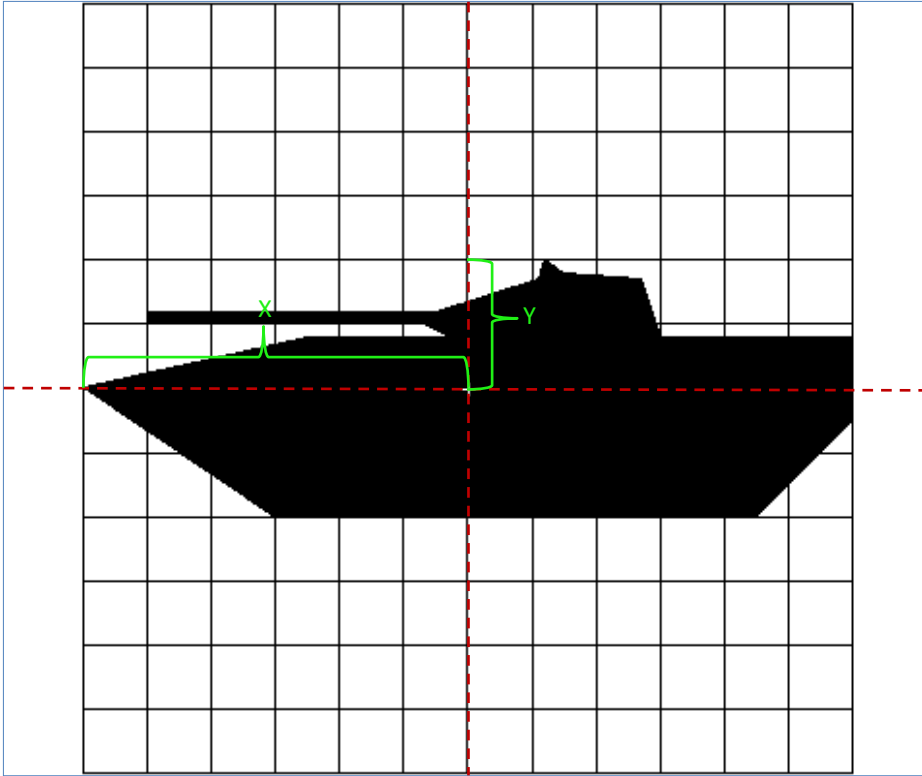

Diameter (mm)	Value

X	600 mm
Y	200 mm

Zoom levels

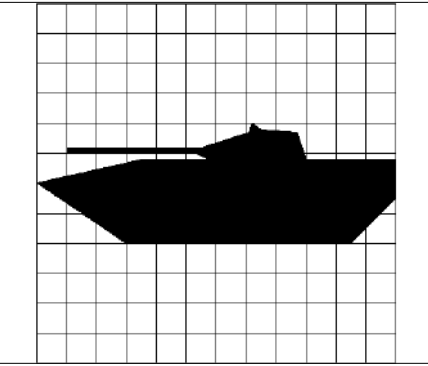

Technical data

Part No	735-0097-97-0081
Size	41 kb
Gauge (default)	12,7 mm
Aiming mark diameter	
Manufacture	
Manufacture Part No	

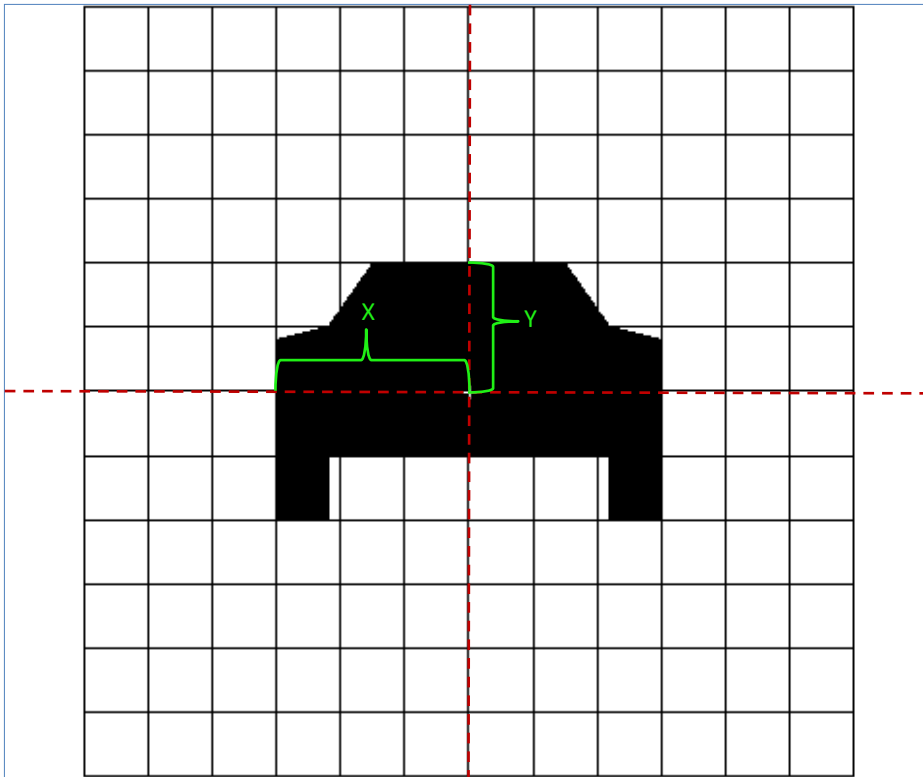

Diameter (mm)	Value

X	300 mm
Y	200 mm

Zoom levels

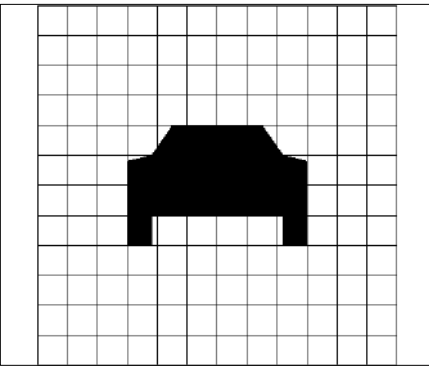

Technical data

Part No	735-0097-97-0082
Size	42 kb
Gauge (default)	12,7 mm
Aiming mark diameter	
Manufacture	
Manufacture Part No	

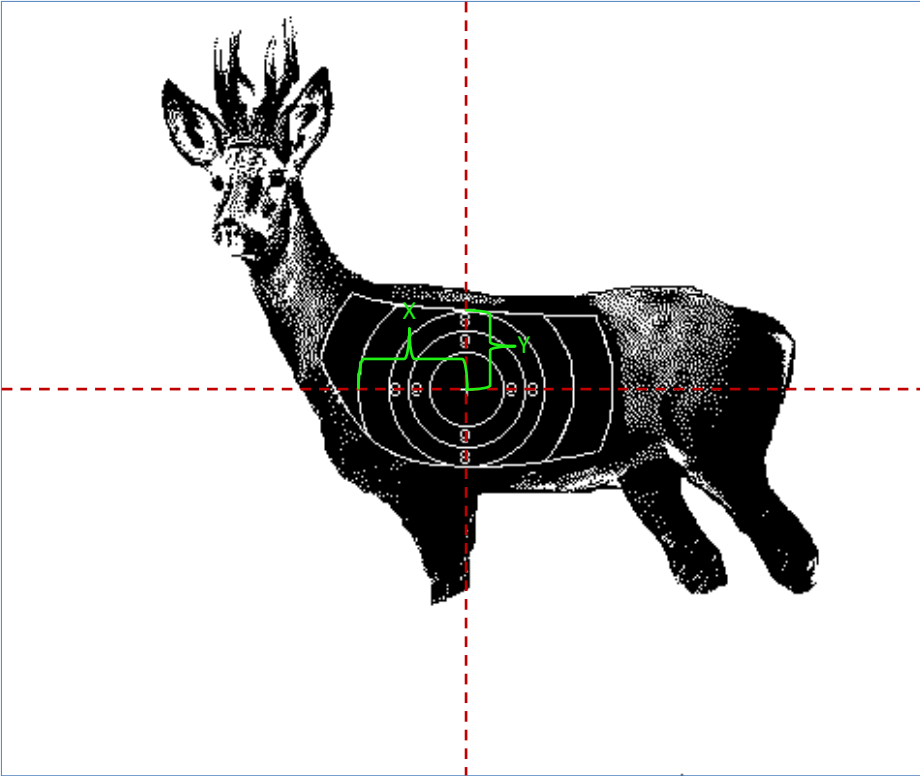

Diameter (mm)	Value
95	X
144	9
194	8

X	97 mm
Y	97 mm

Zoom levels

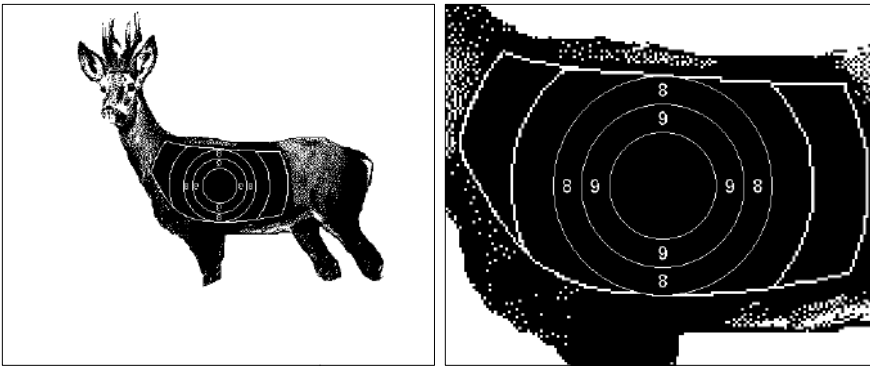

Technical data

Part No	735-0097-97-0083
Size	38 kb
Gauge (default)	8 mm
Aiming mark diameter	194 mm
Manufacture	DJV
Manufacture Part No	DJV NR1 Links (Rehbock)

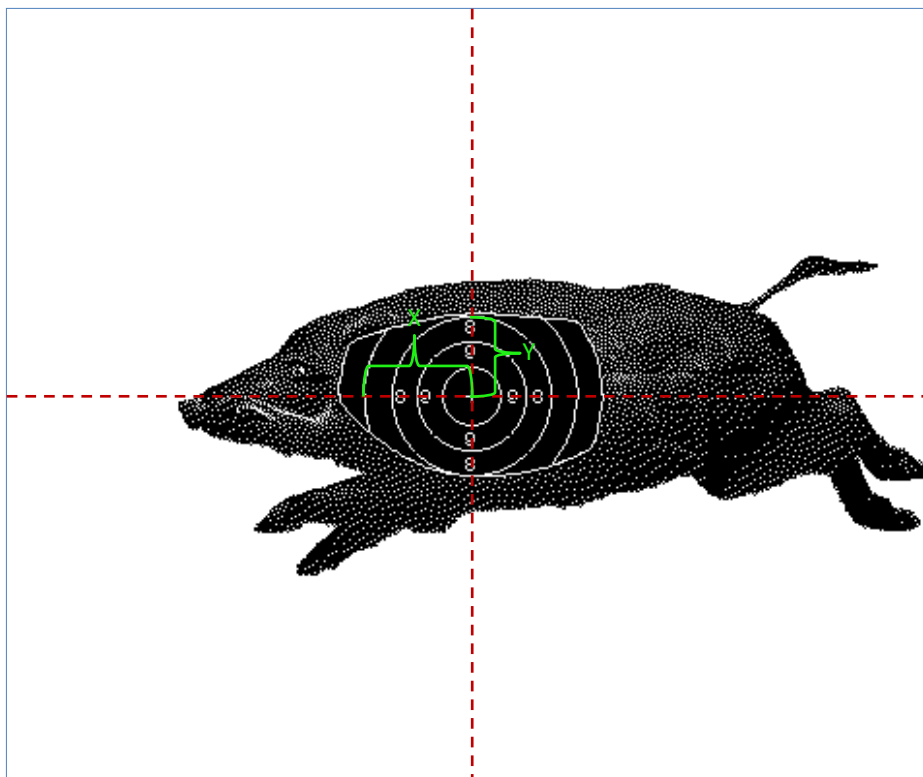

Diameter (mm)	Value
100	X
185	9
270	8

X	135 mm
Y	135 mm

Zoom levels

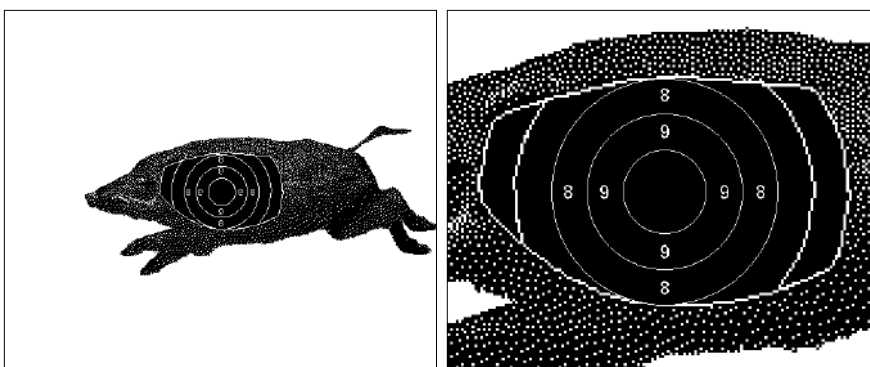

Technical data

Part No	735-0097-97-0084
Size	39 kb
Gauge (default)	8 mm
Aiming mark diameter	270 mm
Manufacture	DJV
Manufacture Part No	DJV NR5 Links (lfd.Keiler)

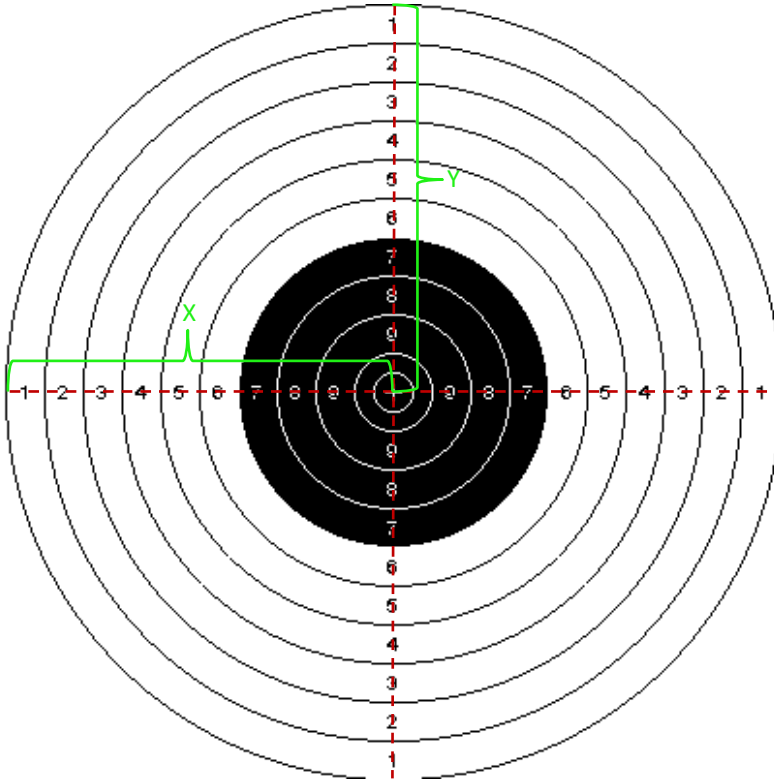

Diameter (mm)	Value
12,5	*
25	X
50	9
75	8
100	7
125	6
150	5
175	4
200	3
225	2
250	1

X	125 mm
Y	125 mm

Zoom levels

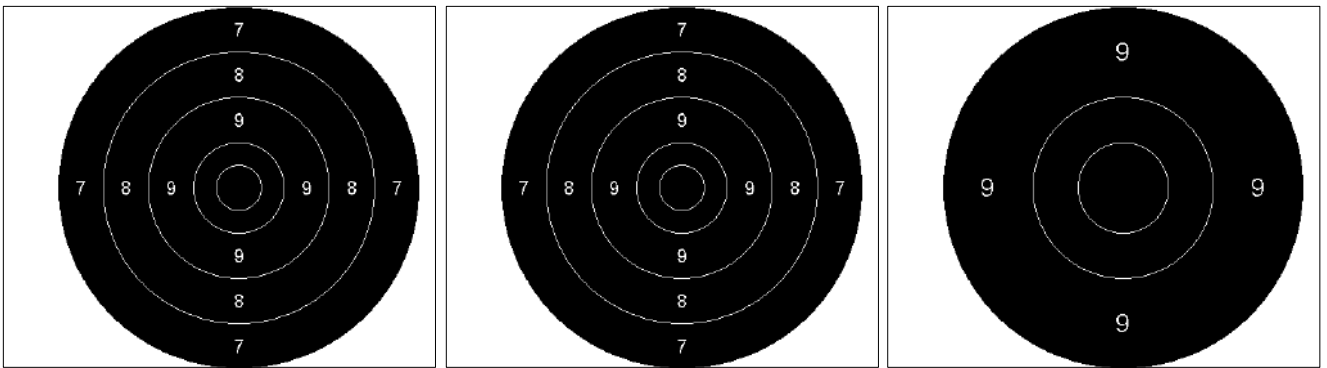

Technical data

Part No	735-0097-97-0085
Size	N/A
Gauge (default)	5,6 mm
Aiming mark diameter	100 mm
Manufacture	
Manufacture Part No	

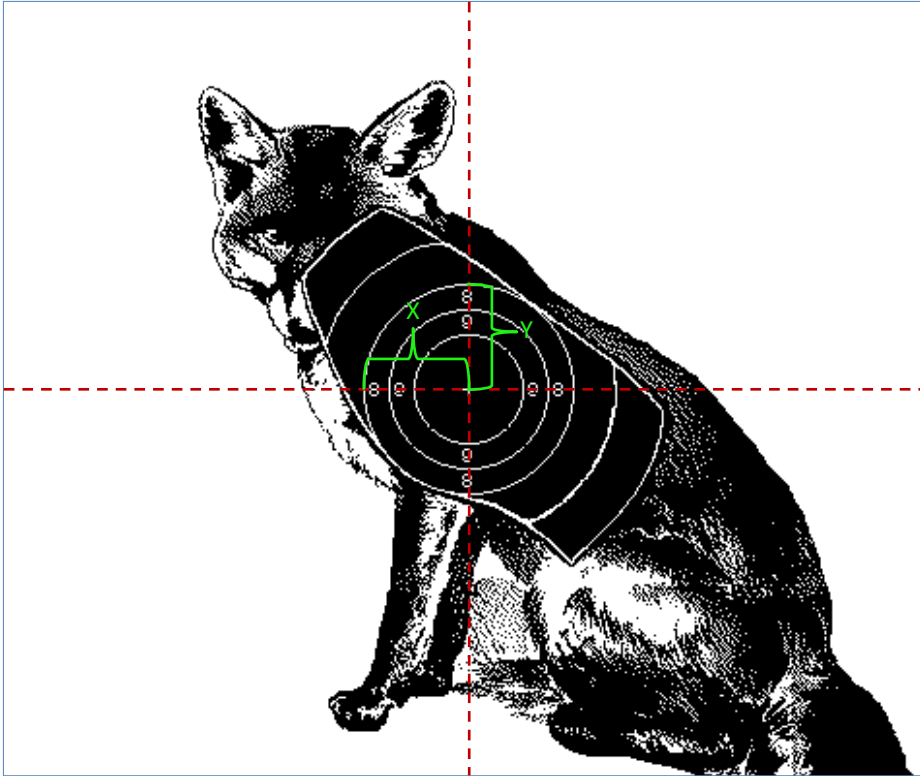

Diameter (mm)	Value
90	X
130	9
170	8

X	85 mm
Y	85 mm

Zoom levels

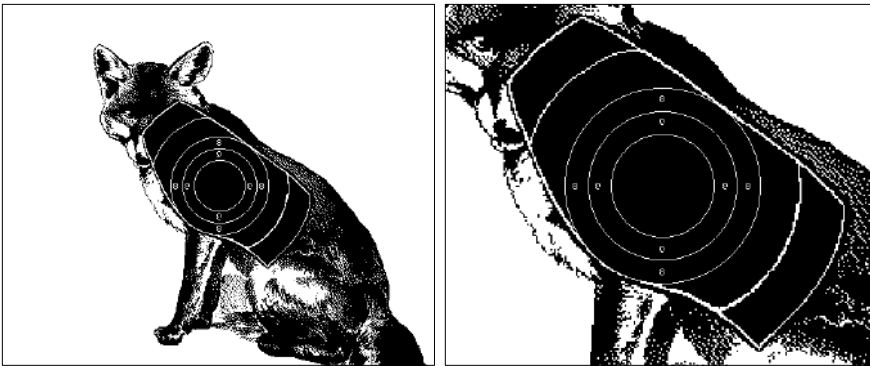

Technical data

Part No	735-0097-97-0086
Size	39 kb
Gauge (default)	8 mm
Aiming mark diameter	170 mm
Manufacture	DJV
Manufacture Part No	DJV NR 3 Links (Funchs)

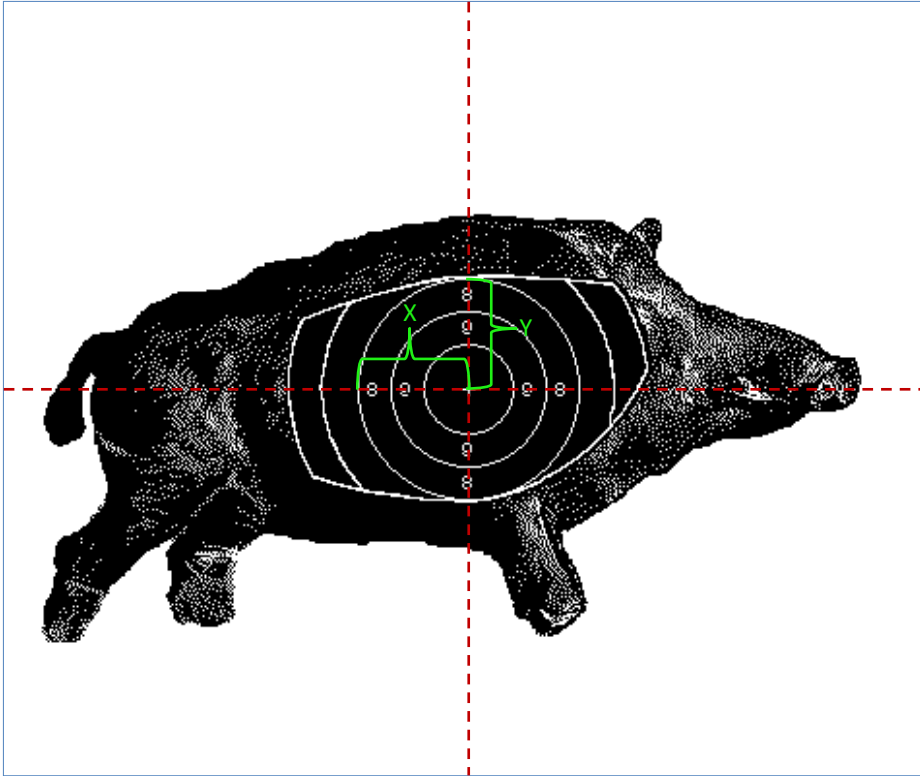

Diameter (mm)	Value
100	X
175	9
250	8

X	125 mm
Y	125 mm

Zoom levels

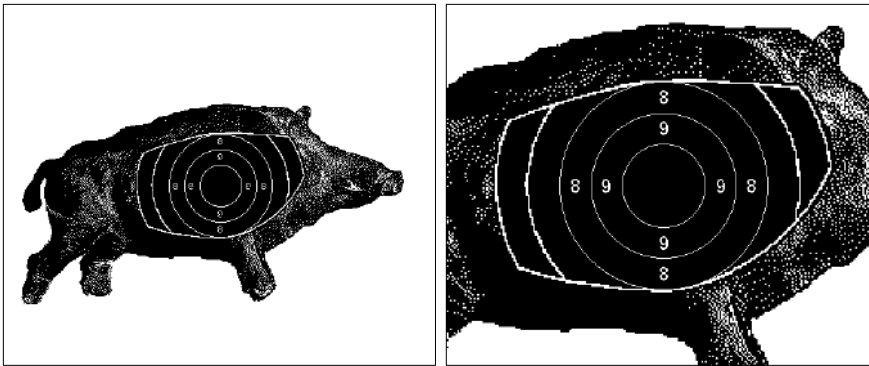

Technical data

Part No	735-0097-97-0087
Size	44 kb
Gauge (default)	8 mm
Aiming mark diameter	250 mm
Manufacture	DJV
Manufacture Part No	DJV NR2 Rechts (Überläufer)

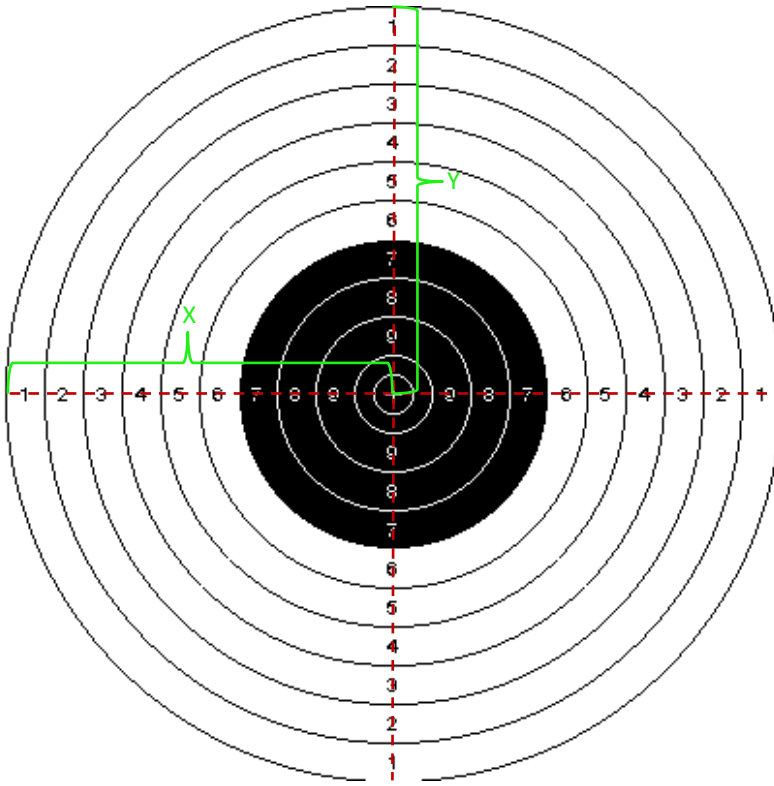

Diameter (mm)	Value
25	*
50	X
100	9
150	8
200	7
250	6
300	5
350	4
400	3
450	2
500	1

X	250 mm
Y	250 mm

Zoom levels

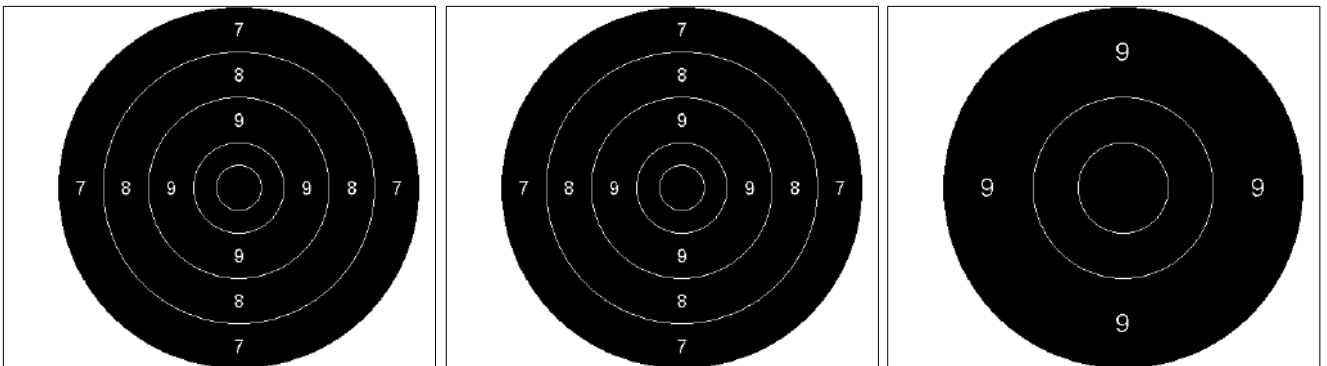

Technical data

Part No	735-0097-97-0088
Size	N/A
Gauge (default)	8 mm
Aiming mark diameter	200 mm
Manufacture	
Manufacture Part No	

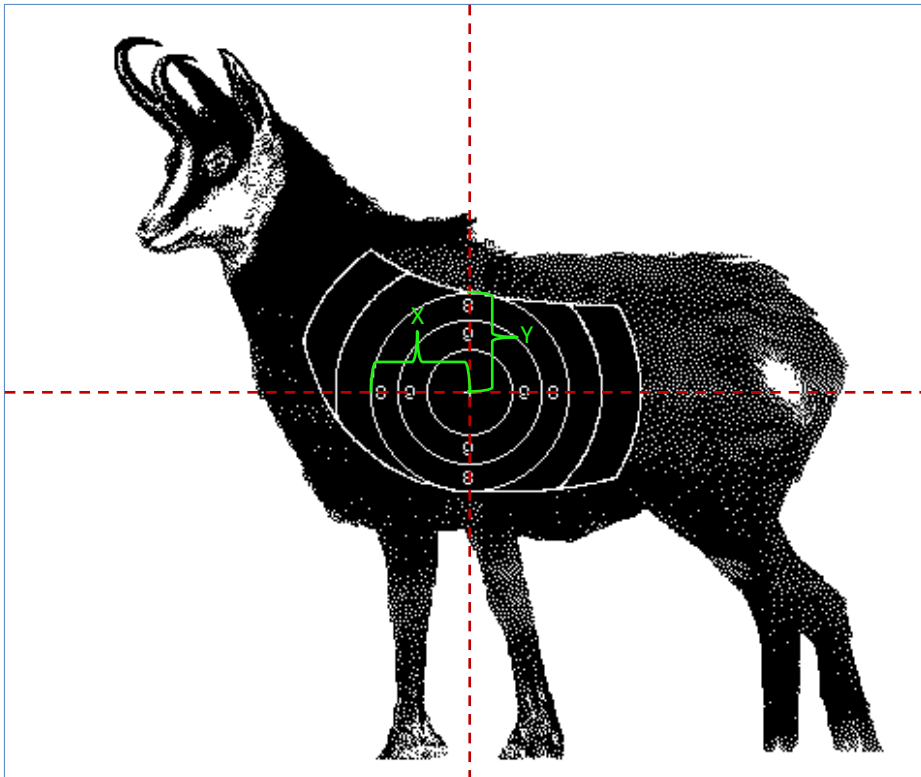

Diameter (mm)	Value
100	X
165	9
230	8

X	115 mm
Y	115 mm

Zoom levels

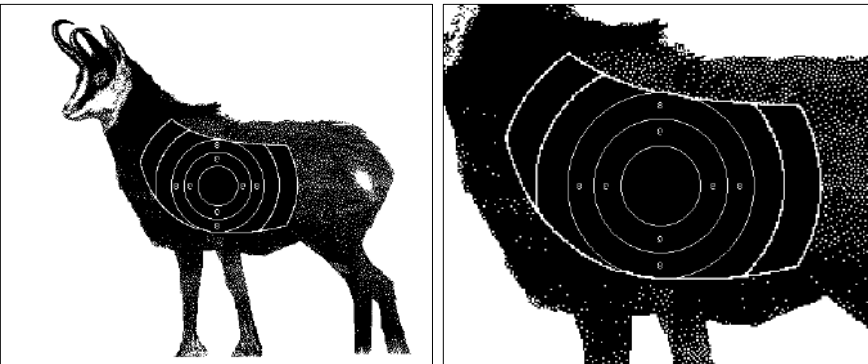

Technical data

Part No	735-0097-97-0089
Size	72 kb
Gauge (default)	8 mm
Aiming mark diameter	230 mm
Manufacture	DJV
Manufacture Part No	DJV NR4 Links (Gamsbock)

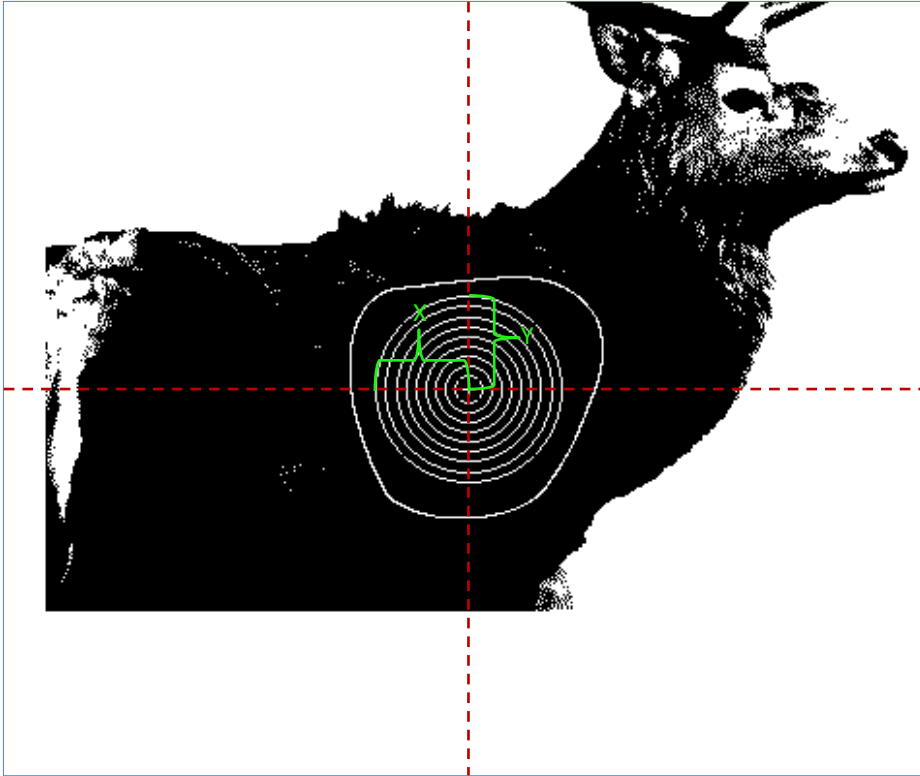

Diameter (mm)	Value
33	X
55	9
77	8
99	7
121	6
143	5
165	4
187	3
209	2

X	104,5 mm
Y	104,5 mm

Zoom levels

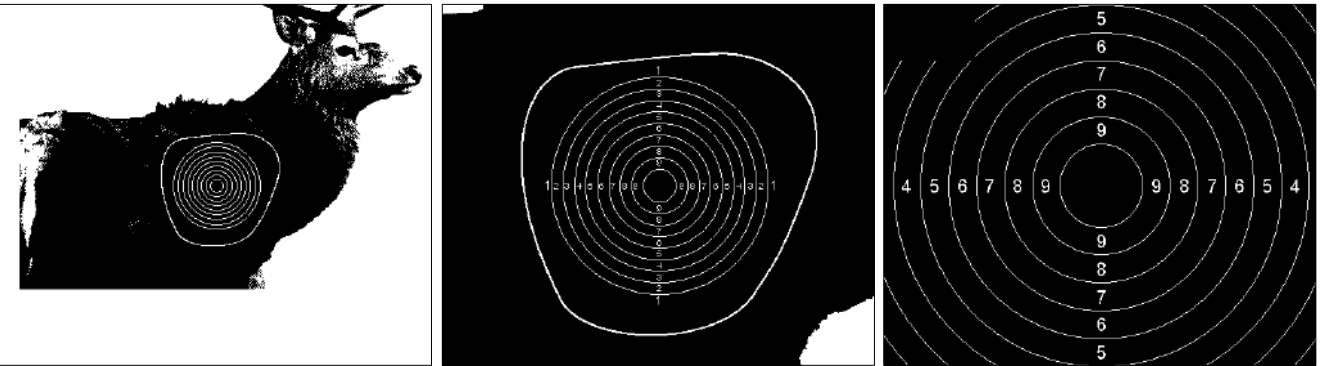

Technical data

Part No	735-0097-97-0090
Size	27 kb
Gauge (default)	8 mm
Aiming mark diameter	209 mm
Manufacture	BEO
Manufacture Part No	BEO-Hjort-2

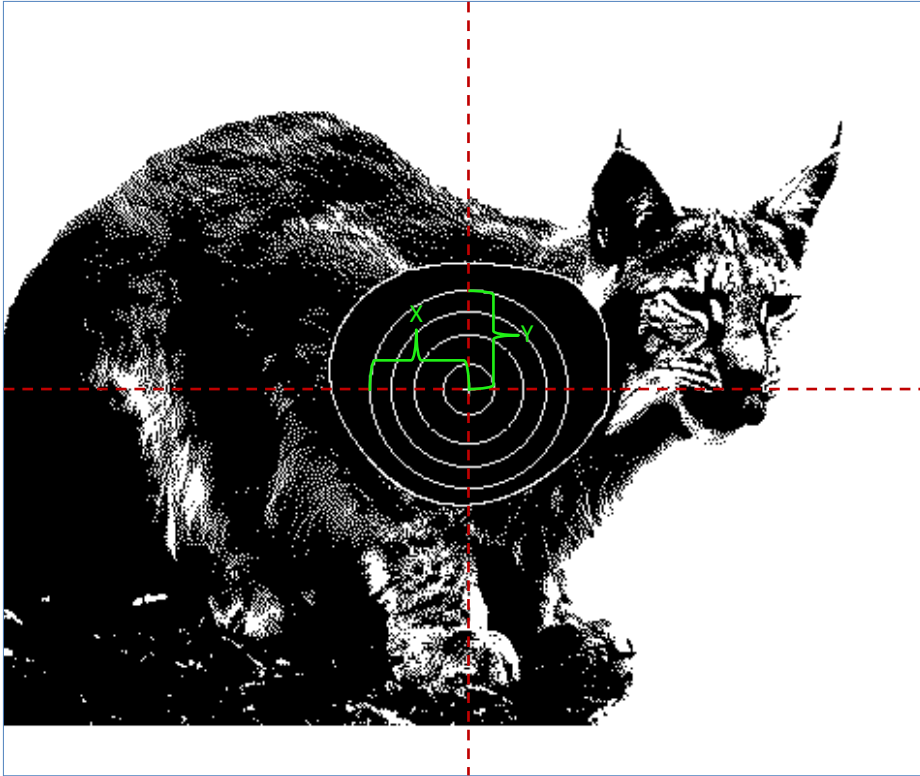

Diameter (mm)	Value
58	X
119	4
167	3
215	2

X	107,5 mm
Y	107,5 mm

Zoom levels

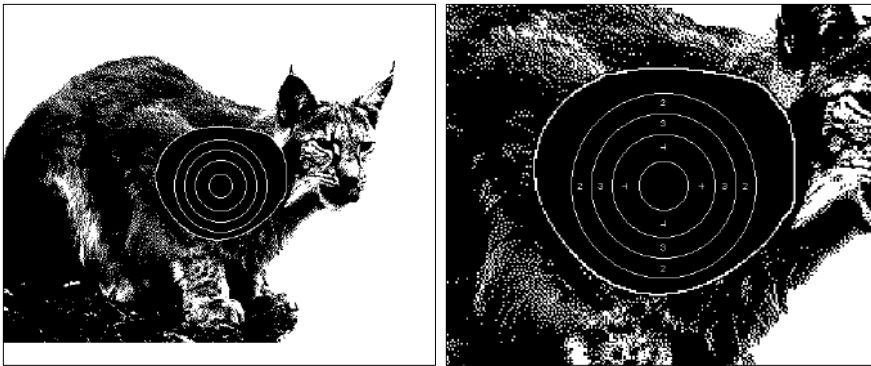

Technical data

Part No	735-0097-97-0091
Size	49 kb
Gauge (default)	8 mm
Aiming mark diameter	215 mm
Manufacture	BEO
Manufacture Part No	BEO-Gaupe-2

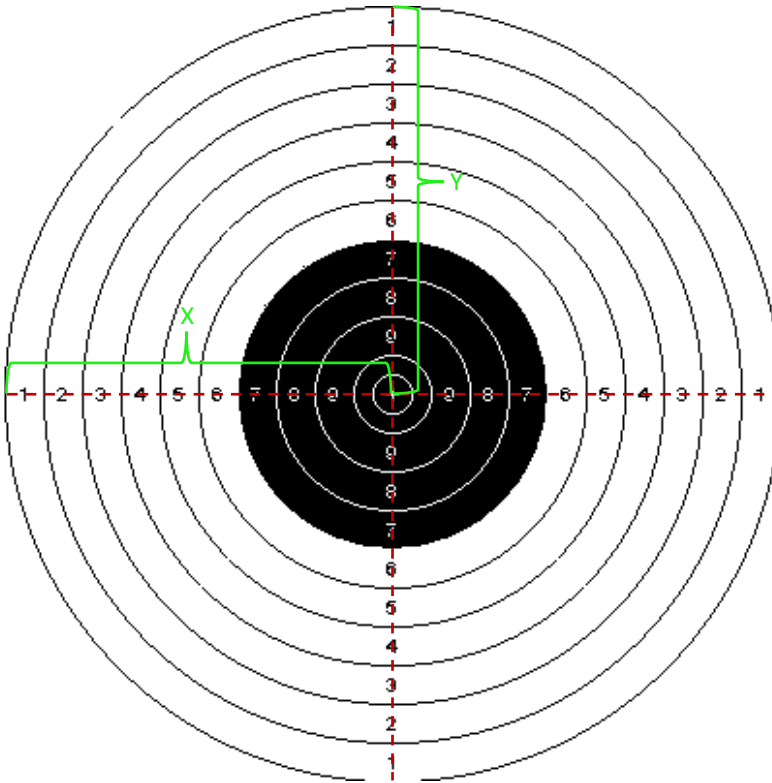

Diameter (mm)	Value
30	*
60	X
120	9
180	8
240	7
300	6
360	5
420	4
480	3
540	2
600	1

X	300 mm
Y	300 mm

Zoom levels

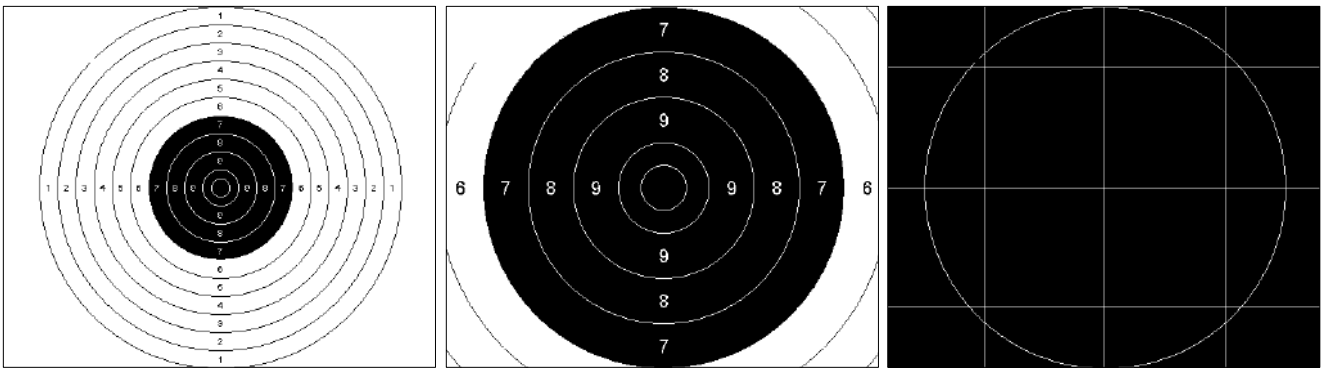

Technical data

Part No	735-0097-97-0092
Size	9 kb
Gauge (default)	8 mm
Aiming mark diameter	240 mm
Manufacture	
Manufacture Part No	

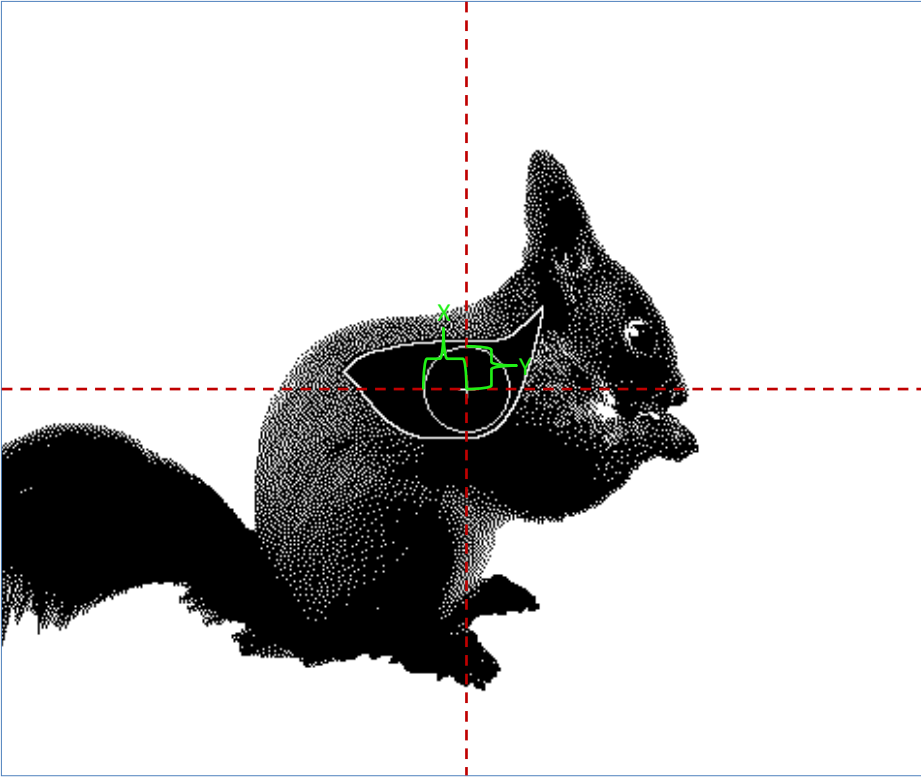

Diameter (mm)	Value
37	5

X	18,5 mm
Y	18,5 mm

Zoom levels

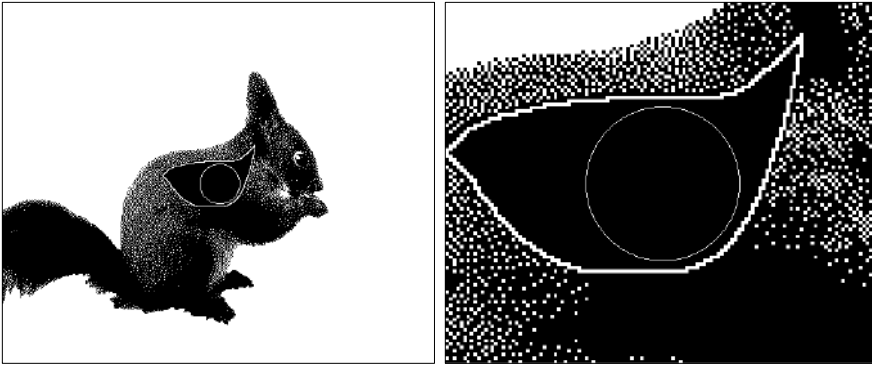

Technical data

Part No	735-0097-97-0093
Size	37 kb
Gauge (default)	8 mm
Aiming mark diameter	37 mm
Manufacture	BEO
Manufacture Part No	BEO-Ekorn

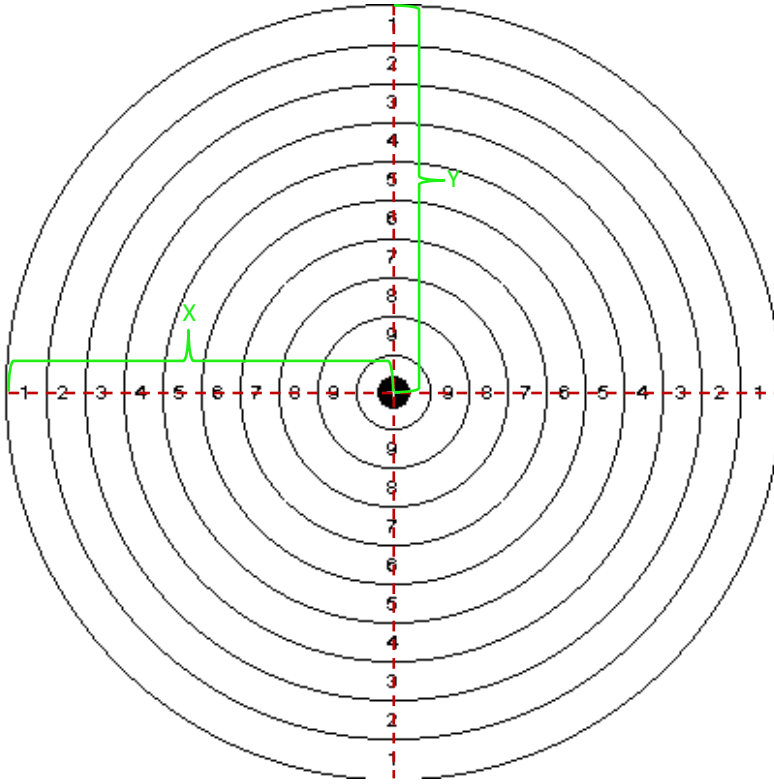

Diameter (mm)	Value
30,7	*
64	X
130,6	9
197,2	8
263,8	7
330,4	6
397,3	5
463,9	4
530,5	3
597,1	2
664	1

X	332 mm
Y	332 mm

Zoom levels

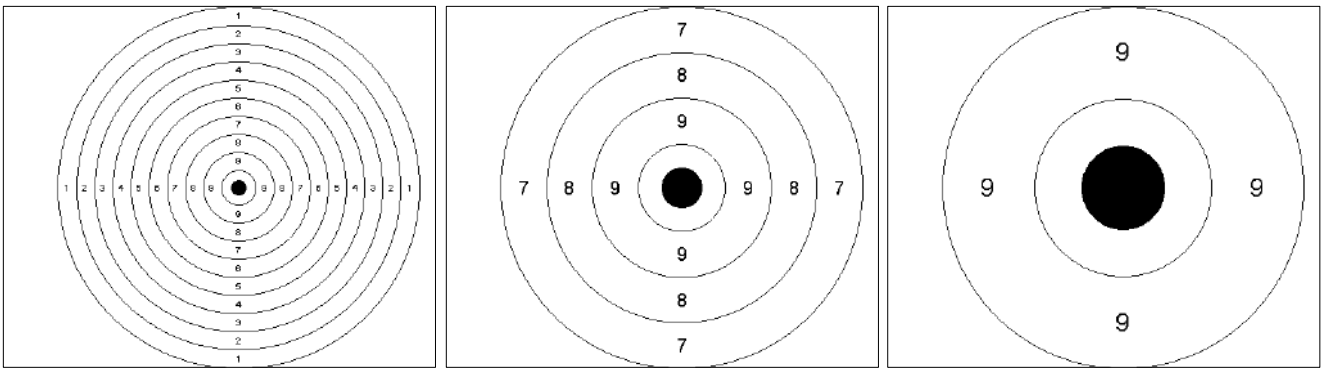

Technical data

Part No	735-0097-97-0094
Size	N/A
Gauge (default)	8 mm
Aiming mark diameter	30,7 mm
Manufacture	
Manufacture Part No	

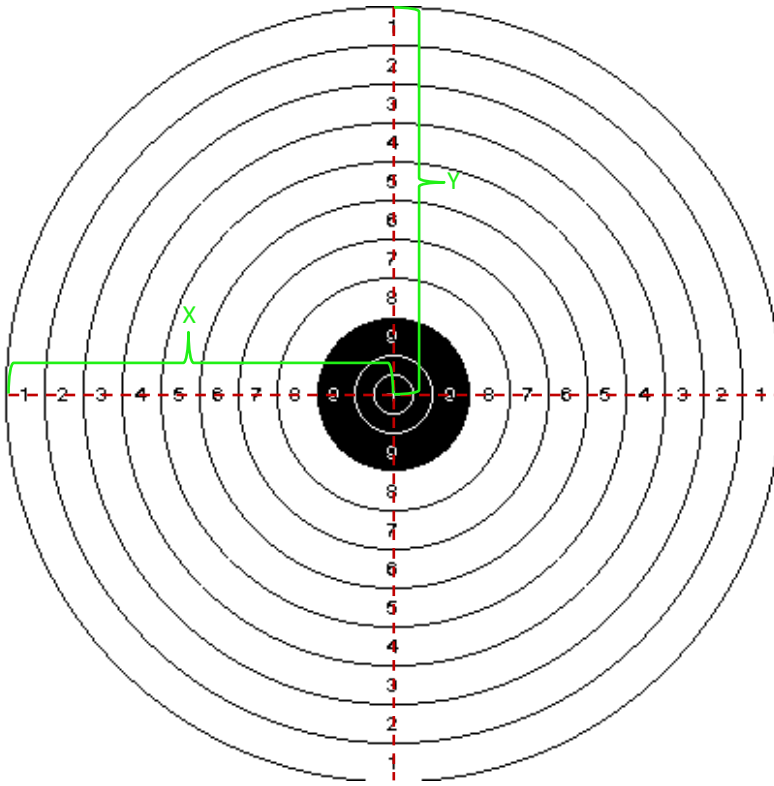

Diameter (mm)	Value
50	*
100	X
200	9
300	8
400	7
500	6
600	5
700	4
800	3
900	2
1000	1

X	500 mm
Y	500 mm

Zoom levels

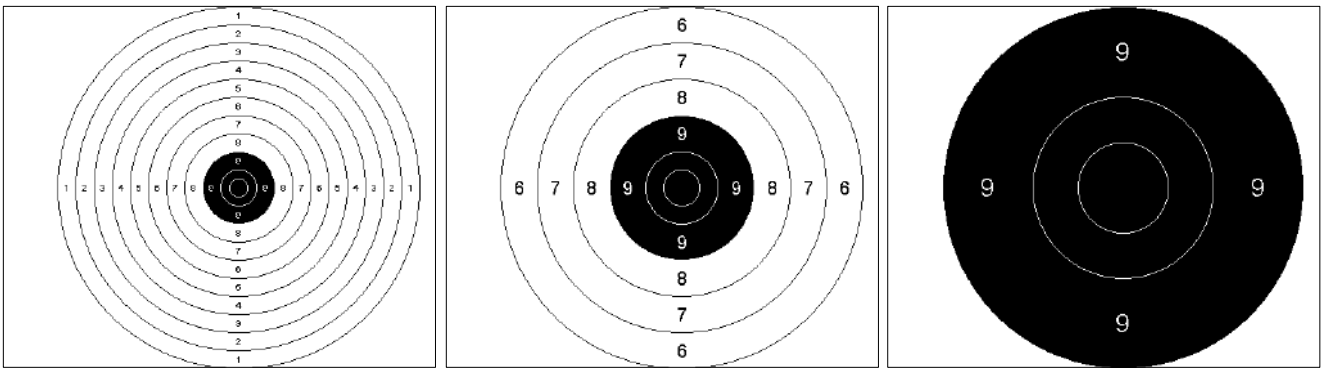

Technical data

Part No	735-0097-97-0095
Size	N/A
Gauge (default)	8 mm
Aiming mark diameter	200 mm
Manufacture	
Manufacture Part No	

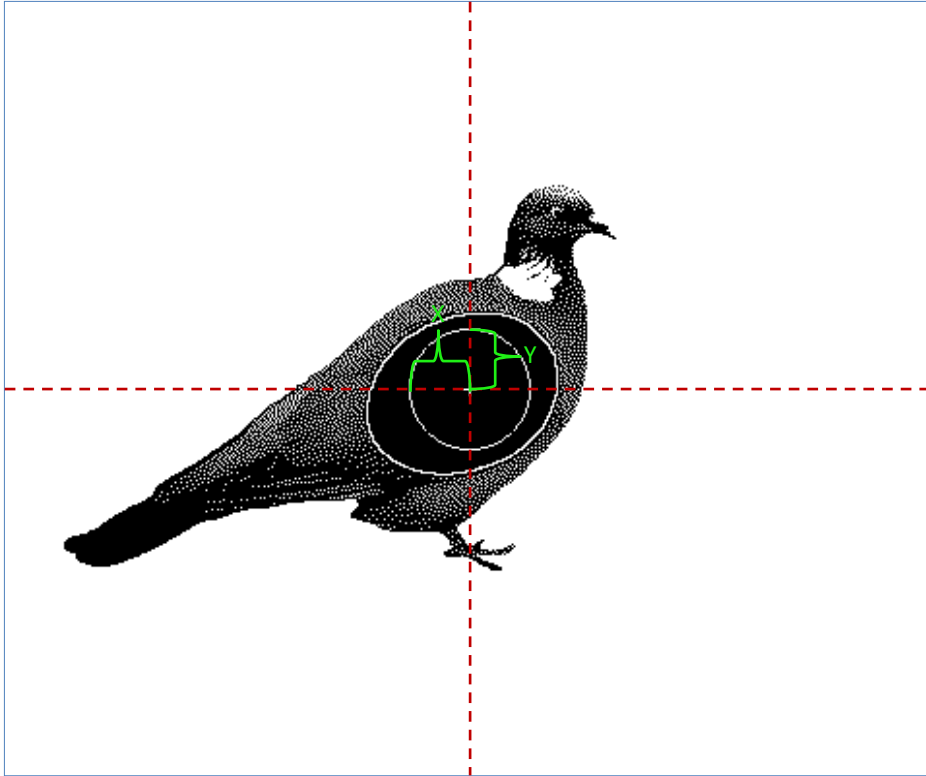

Diameter (mm)	Value
66	5

X	33 mm
Y	33 mm

Zoom levels

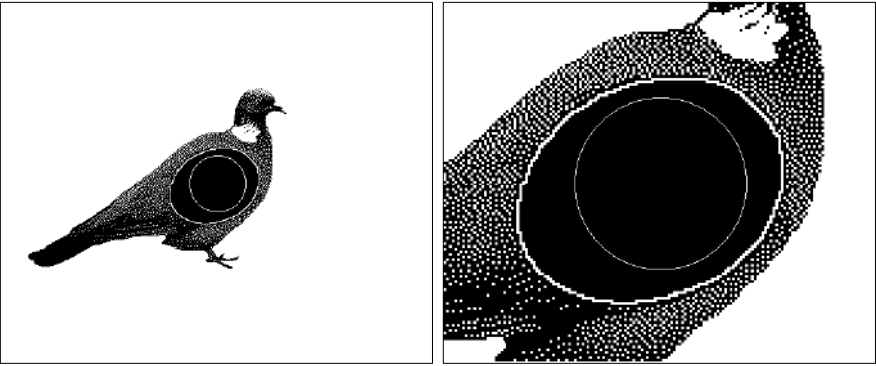

Technical data

Part No	735-0097-97-0096
Size	33 kb
Gauge (default)	8 mm
Aiming mark diameter	66 mm
Manufacture	BEO
Manufacture Part No	BEO-Due

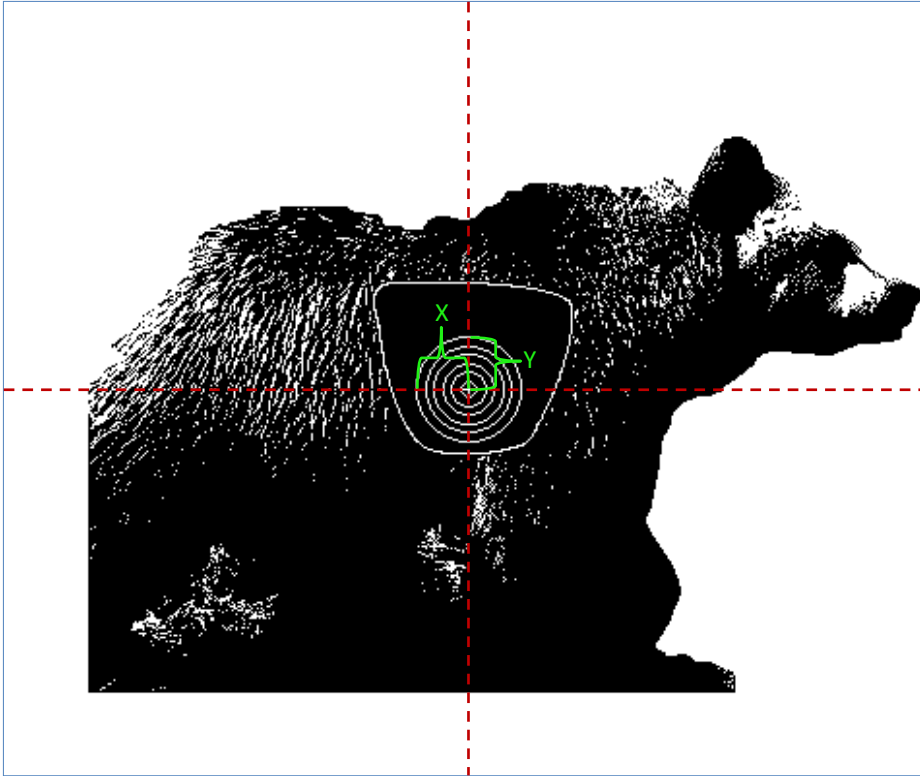

Diameter (mm)	Value
20,6	X
41	9
61,6	8
82	7
102,6	6
123	5

X	61,5 mm
Y	61,5 mm

Zoom levels

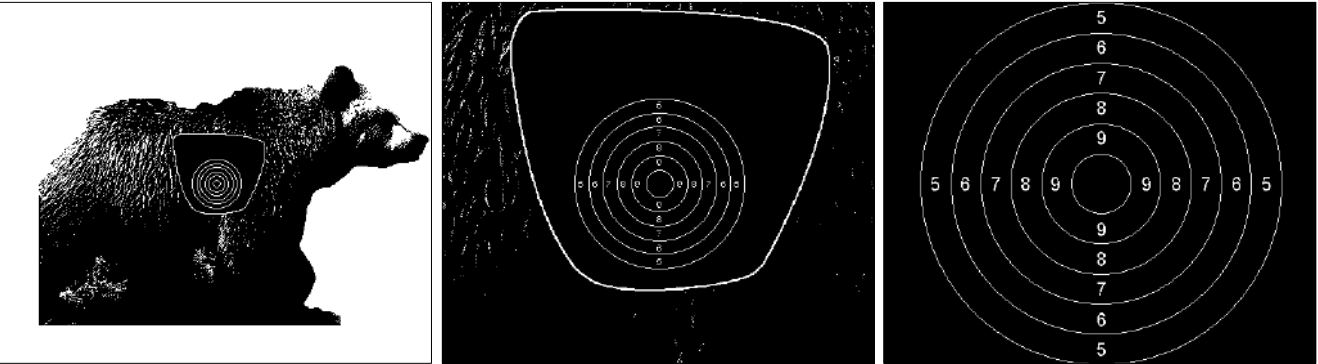

Technical data

Part No	735-0097-97-0097
Size	43 kb
Gauge (default)	8 mm
Aiming mark diameter	123 mm
Manufacture	BEO
Manufacture Part No	BEO-Bjørn

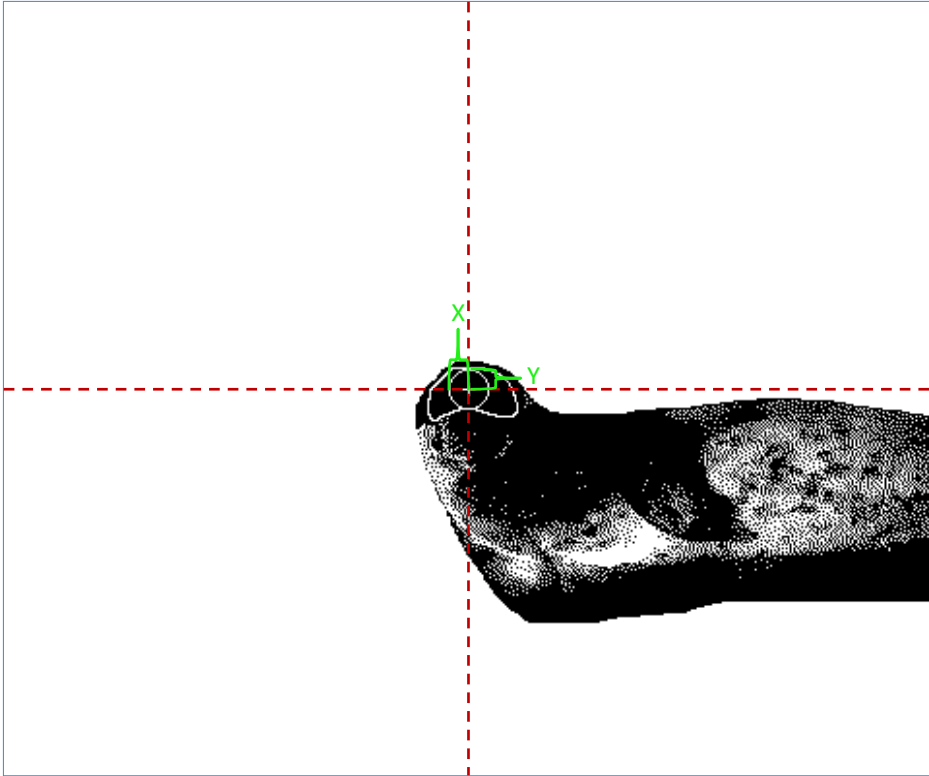

Diameter (mm)	Value
66	5

X	33 mm
Y	33 mm

Zoom levels

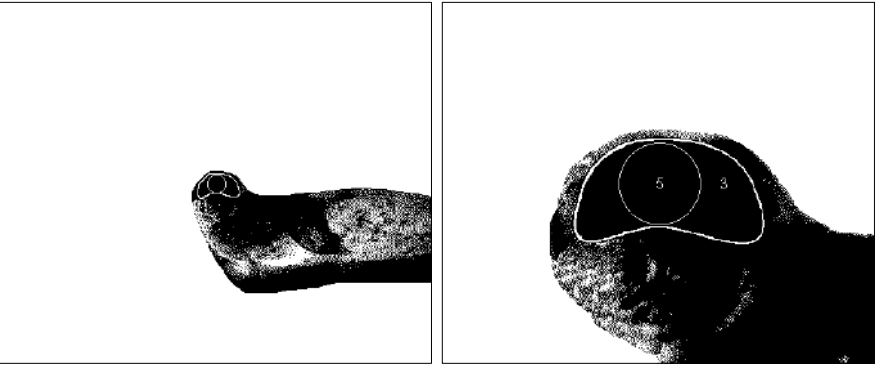

Technical data

Part No	735-0097-97-0098
Size	30 kb
Gauge (default)	8 mm
Aiming mark diameter	66 mm
Manufacture	BEO
Manufacture Part No	BEO-Sel

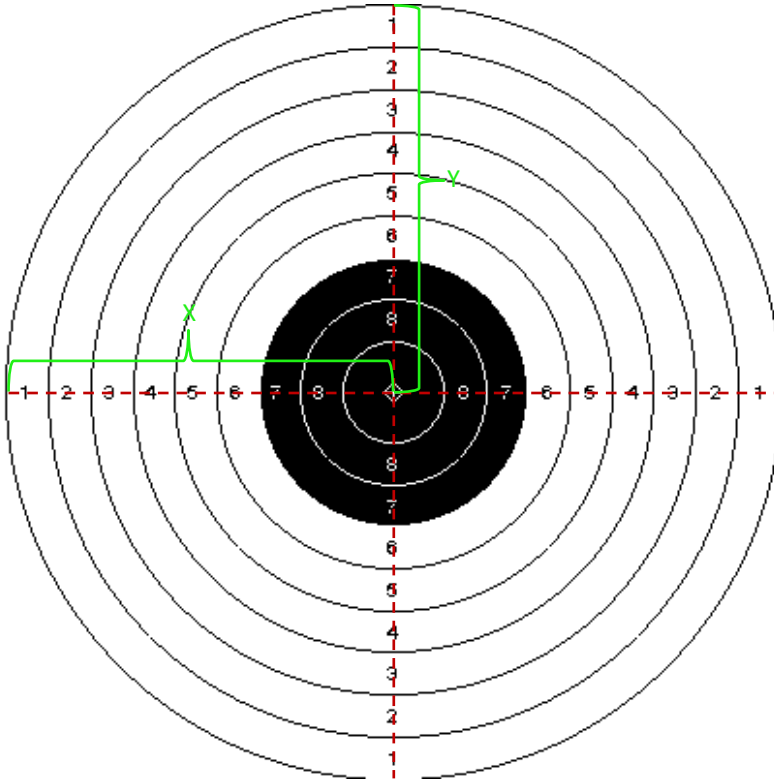

Diameter (mm)	Value
2	X
11	9
20	8
29	7
38	6
47	5
56	4
65	3
74	2
83	1

X	41,5 mm
Y	41,5 mm

Zoom levels

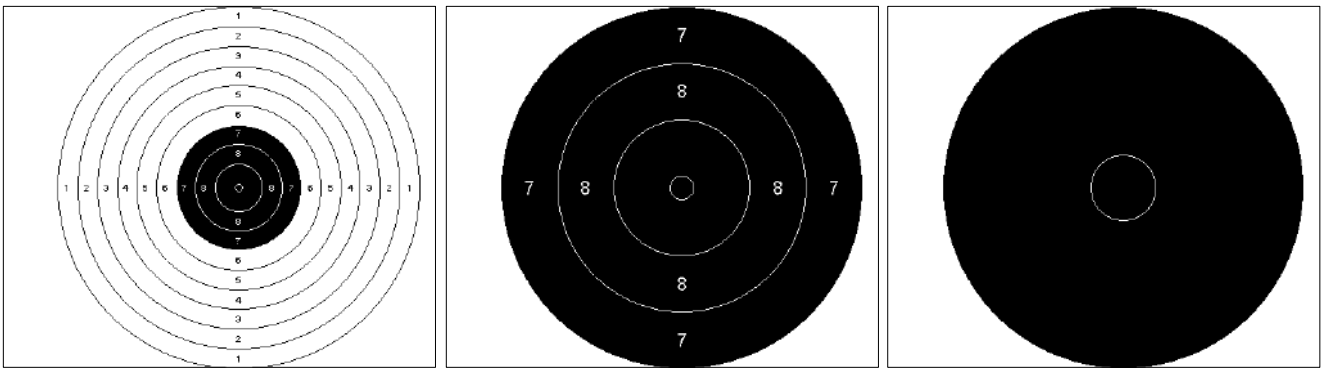

Technical data

Part No	735-0097-97-0099
Size	N/A
Gauge (default)	4,5 mm
Aiming mark diameter	29 mm
Manufacture	
Manufacture Part No	

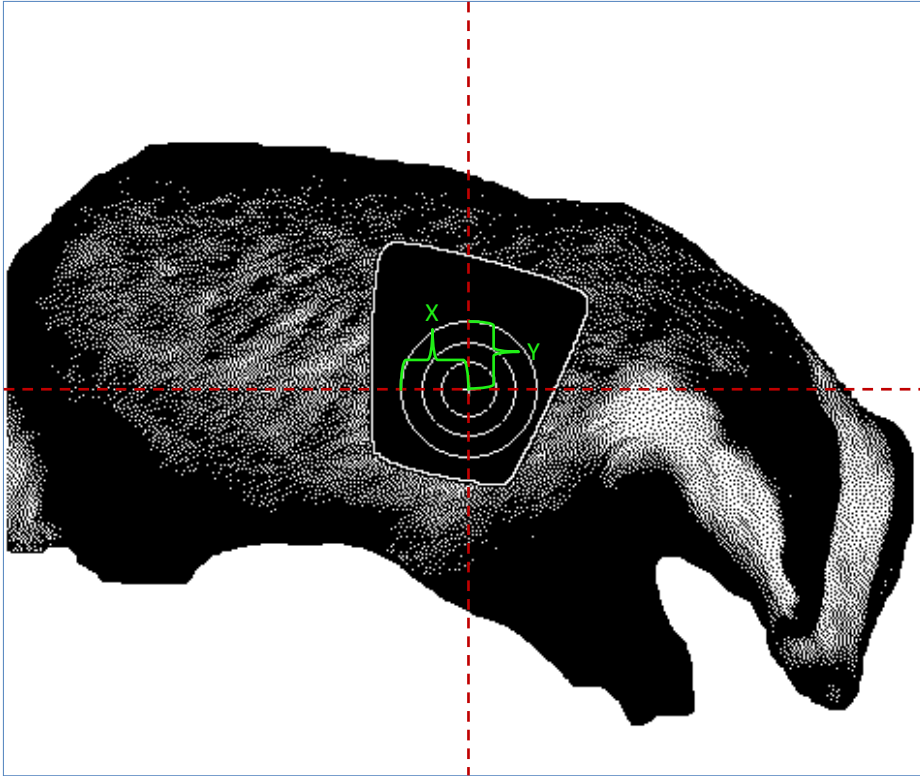

Diameter (mm)	Value
41	X
71	9
103	8

X	51,5 mm
Y	51,5 mm

Zoom levels

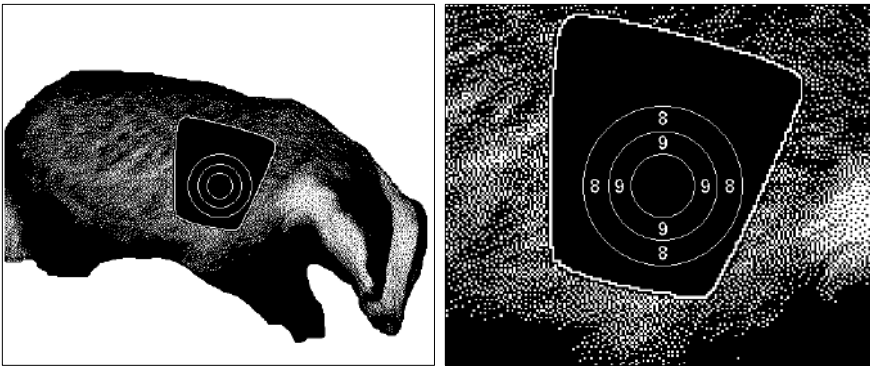

Technical data

Part No	735-0097-97-0100
Size	64 kb
Gauge (default)	8 mm
Aiming mark diameter	103 mm
Manufacture	BEO
Manufacture Part No	BEO-Grevling

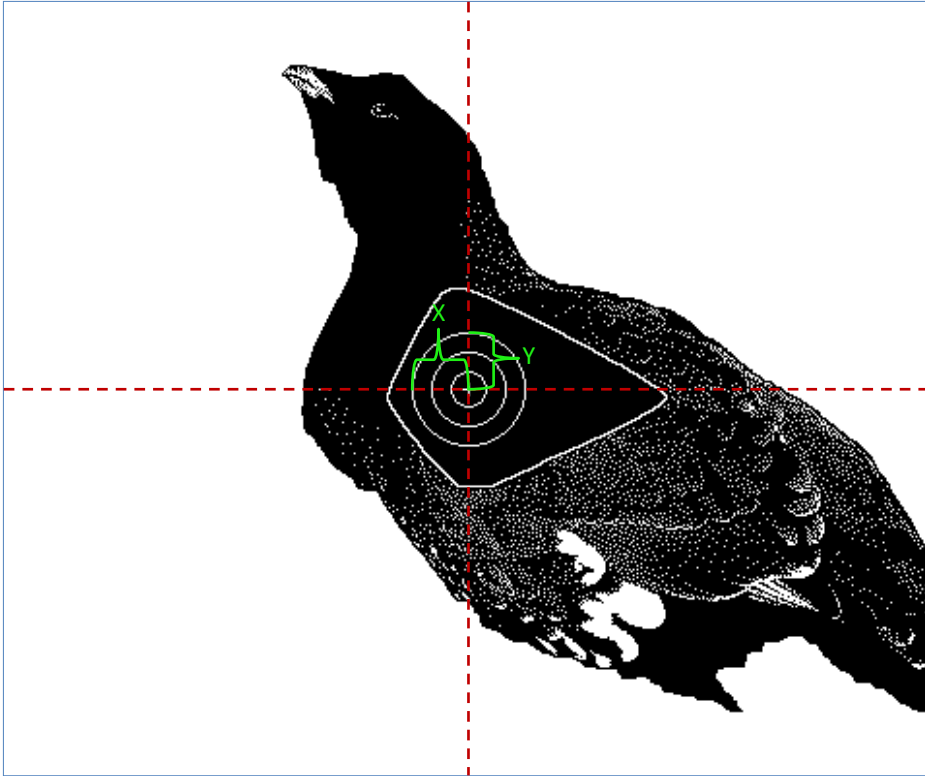

Diameter (mm)	Value
25,6	X
51,2	9
76,8	8

X	38,4 mm
Y	38,4 mm

Zoom levels

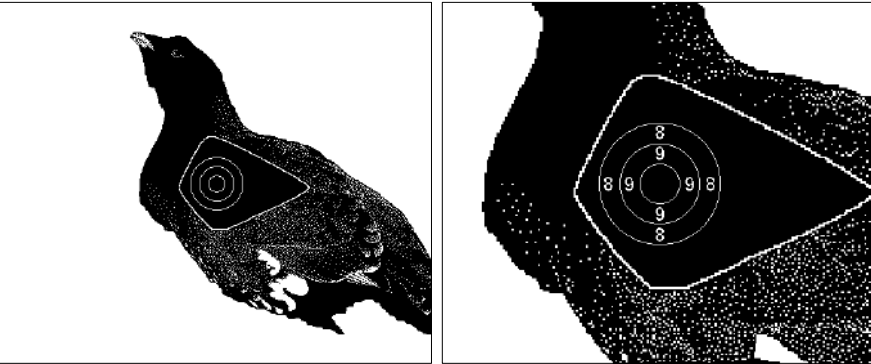

Technical data

Part No	735-0097-97-0101
Size	33 kb
Gauge (default)	8 mm
Aiming mark diameter	76,8 mm
Manufacture	BEO
Manufacture Part No	BEO-Tiur

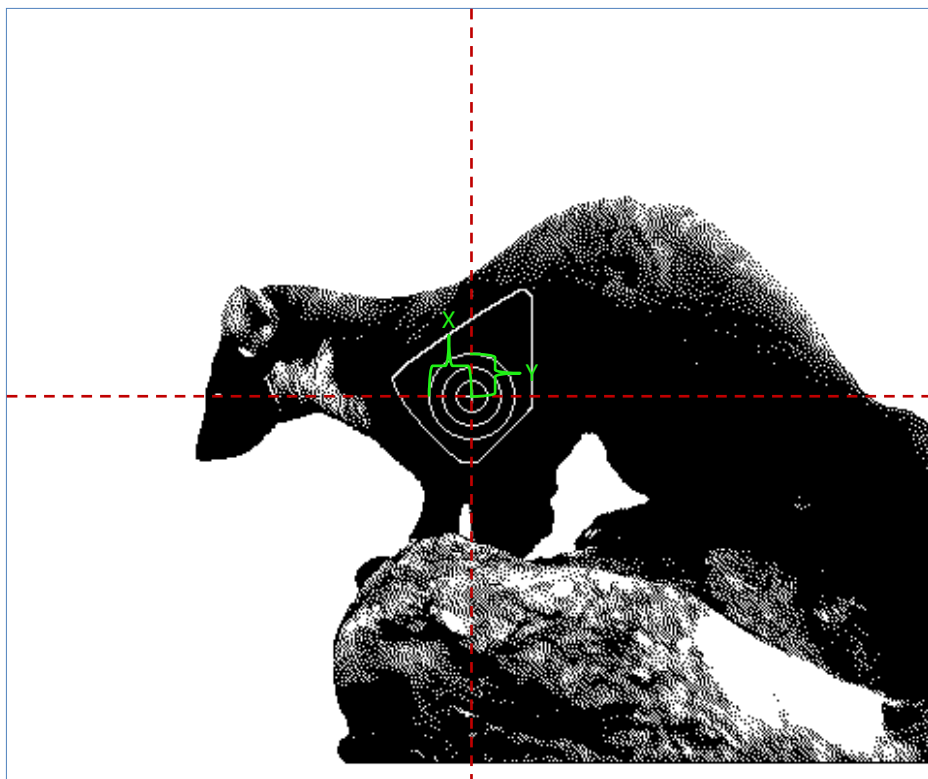

Diameter (mm)	Value
17	X
31	9
45	8

X	22,5 mm
Y	22,5 mm

Zoom levels

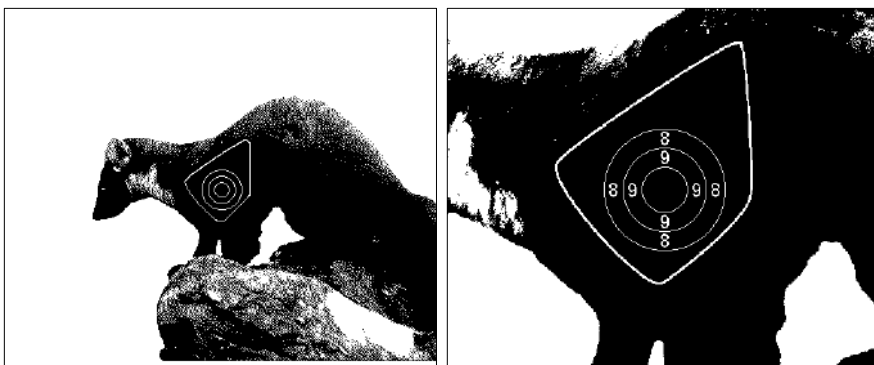

Technical data

Part No	735-0097-97-0102
Size	39 kb
Gauge (default)	8 mm
Aiming mark diameter	45 mm
Manufacture	BEO
Manufacture Part No	BEO-Mår

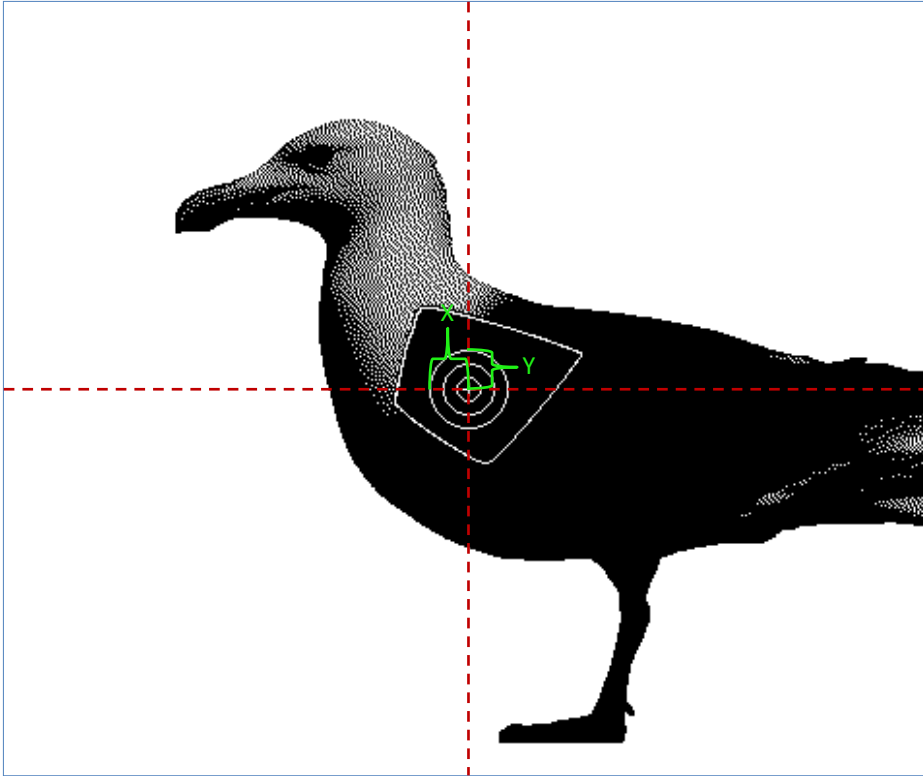

Diameter (mm)	Value
14	X
27	9
42	8

X	21 mm
Y	21 mm

Zoom levels

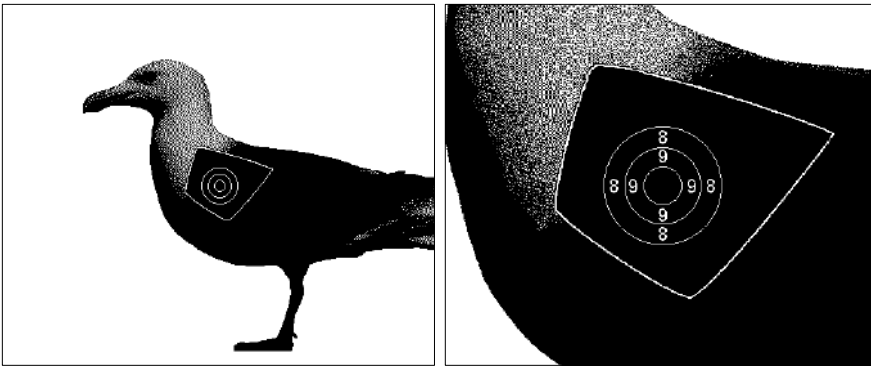

Technical data

Part No	735-0097-97-0103
Size	42 kb
Gauge (default)	8 mm
Aiming mark diameter	21 mm
Manufacture	BEO
Manufacture Part No	BEO-Gråmåke

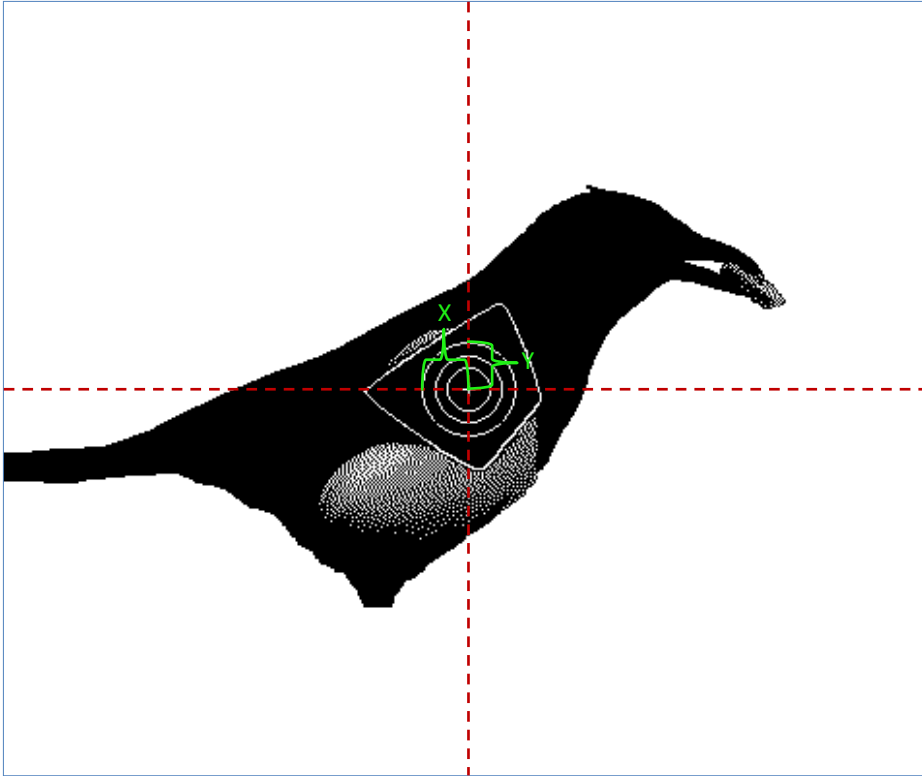

Diameter (mm)	Value
23	X
36	9
51	8

X	25,5 mm
Y	25,5 mm

Zoom levels

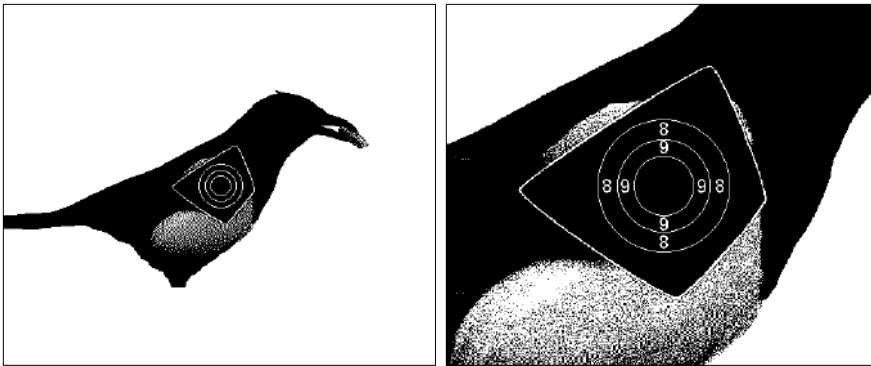

Technical data

Part No	735-0097-97-0104
Size	36 kb
Gauge (default)	8 mm
Aiming mark diameter	51 mm
Manufacture	BEO
Manufacture Part No	BEO-Skjære

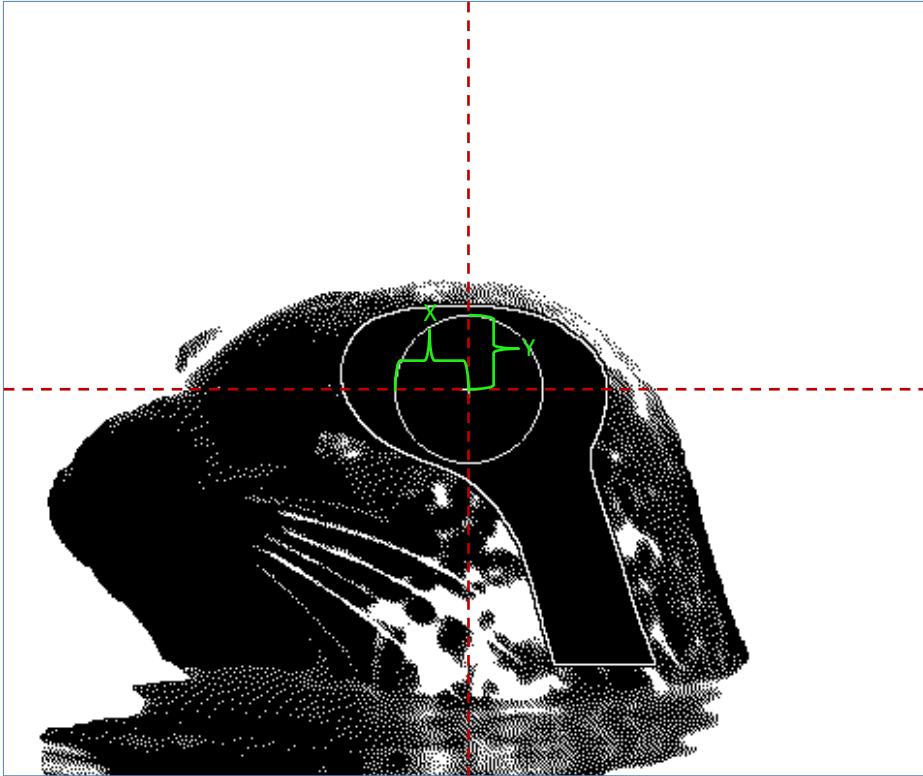

Diameter (mm)	Value
67	5

X	33,5 mm
Y	33,5 mm

Zoom levels

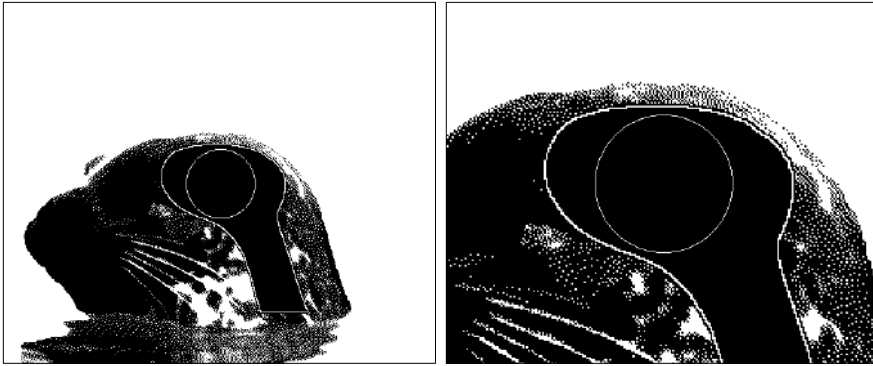

Technical data

Part No	735-0097-97-0105
Size	42 kb
Gauge (default)	8 mm
Aiming mark diameter	67 mm
Manufacture	BEO
Manufacture Part No	BEO-Sel-H

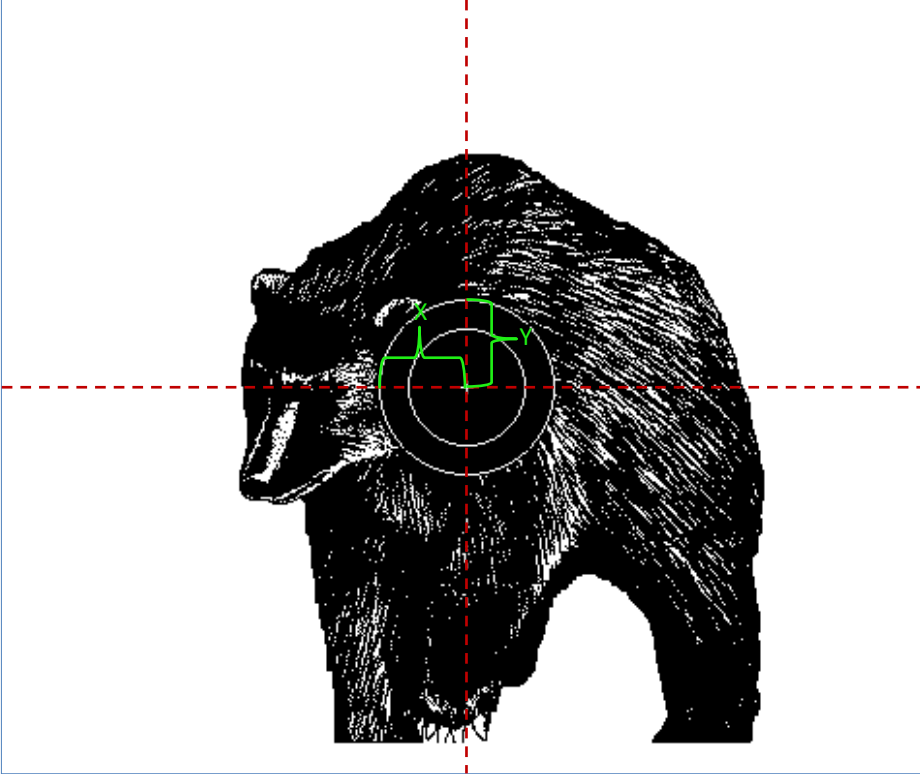

Diameter (mm)	Value
200	5
300	3

X	150 mm
Y	150 mm

Zoom levels

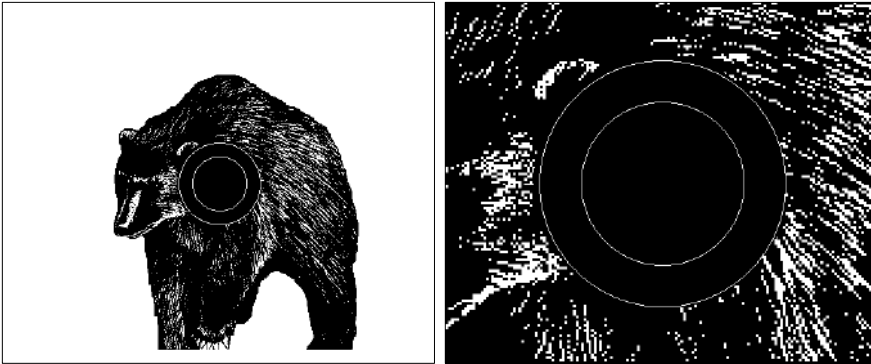

Technical data

Part No	735-0097-97-0106
Size	35 kb
Gauge (default)	8 mm
Aiming mark diameter	300 mm
Manufacture	
Manufacture Part No	

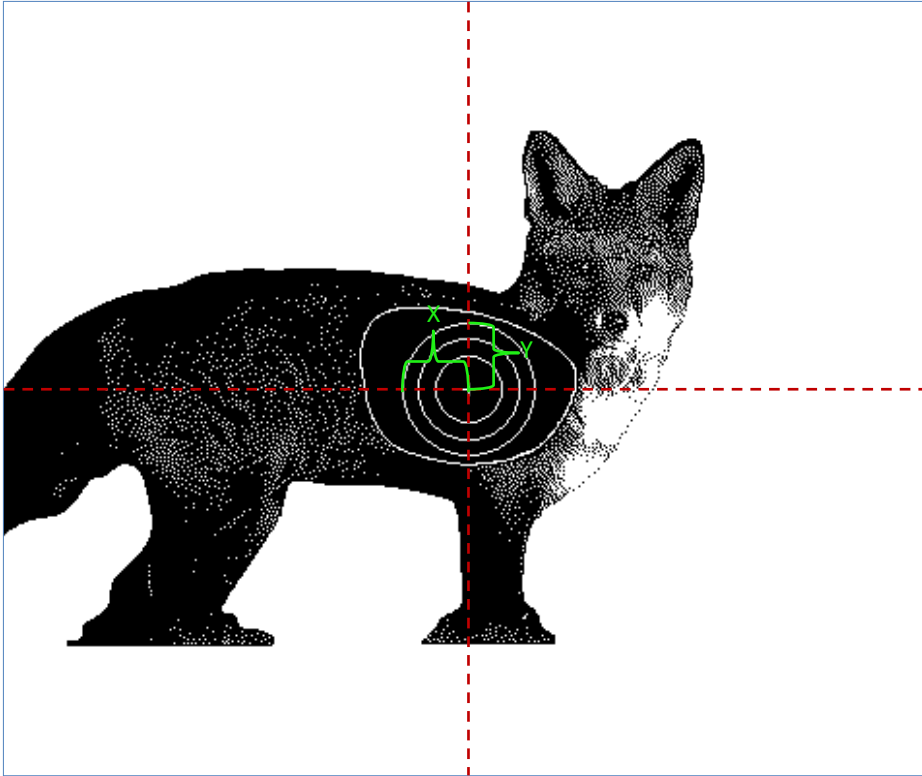

Diameter (mm)	Value
82	5
122	4
162	3

X	81 mm
Y	81 mm

Zoom levels

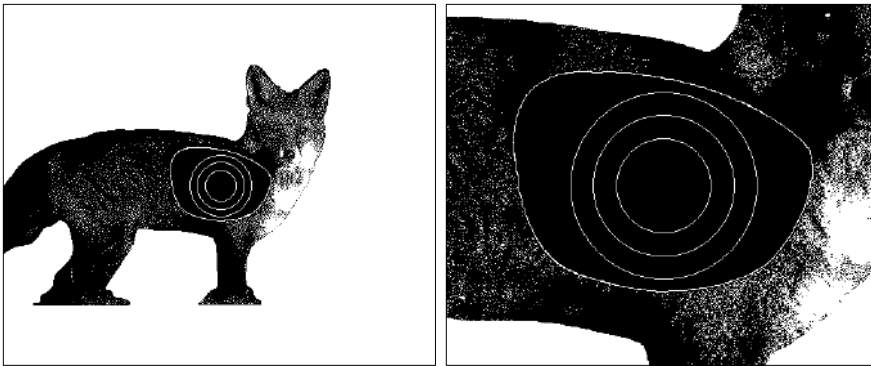

Technical data

Part No	735-0097-97-0107
Size	41 kb
Gauge (default)	8 mm
Aiming mark diameter	162 mm
Manufacture	
Manufacture Part No	

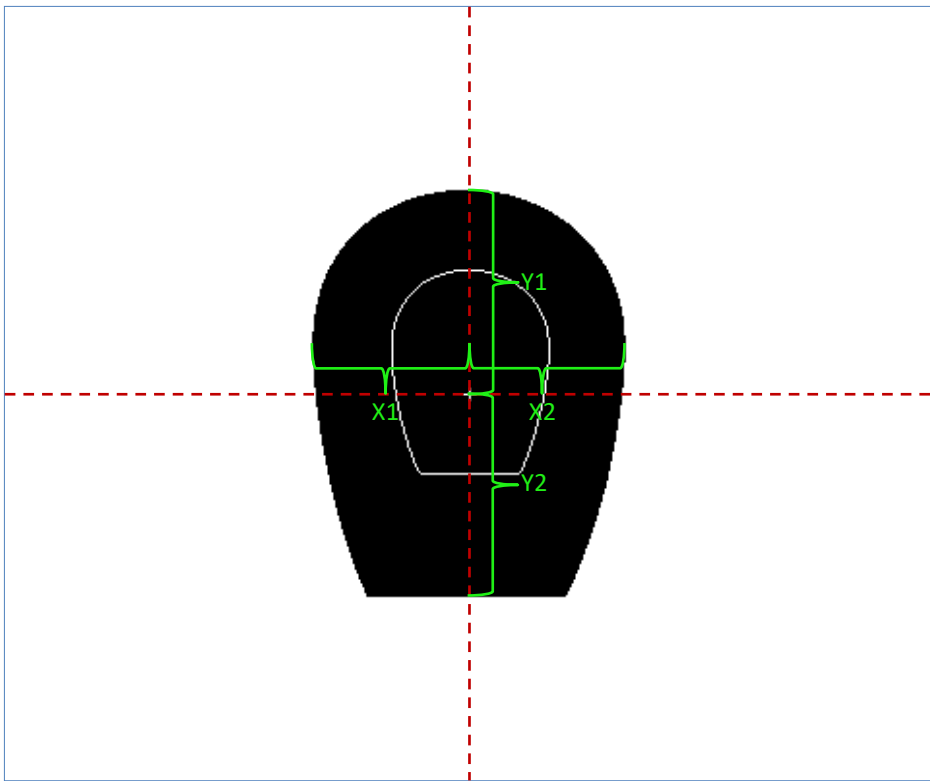

Diameter (mm)	Value

X1	172 mm	X2	172 mm
Y1	224 mm	Y2	224 mm

Zoom levels

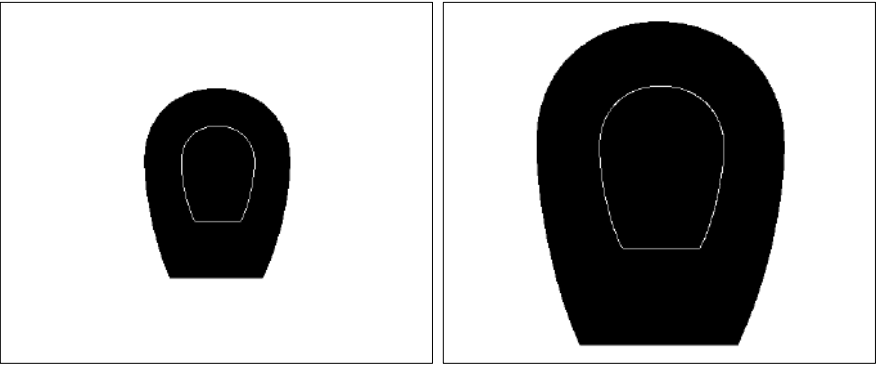

Technical data

Part No	735-0097-97-0108
Size	33 kb
Gauge (default)	8 mm
Aiming mark diameter	
Manufacture	
Manufacture Part No	

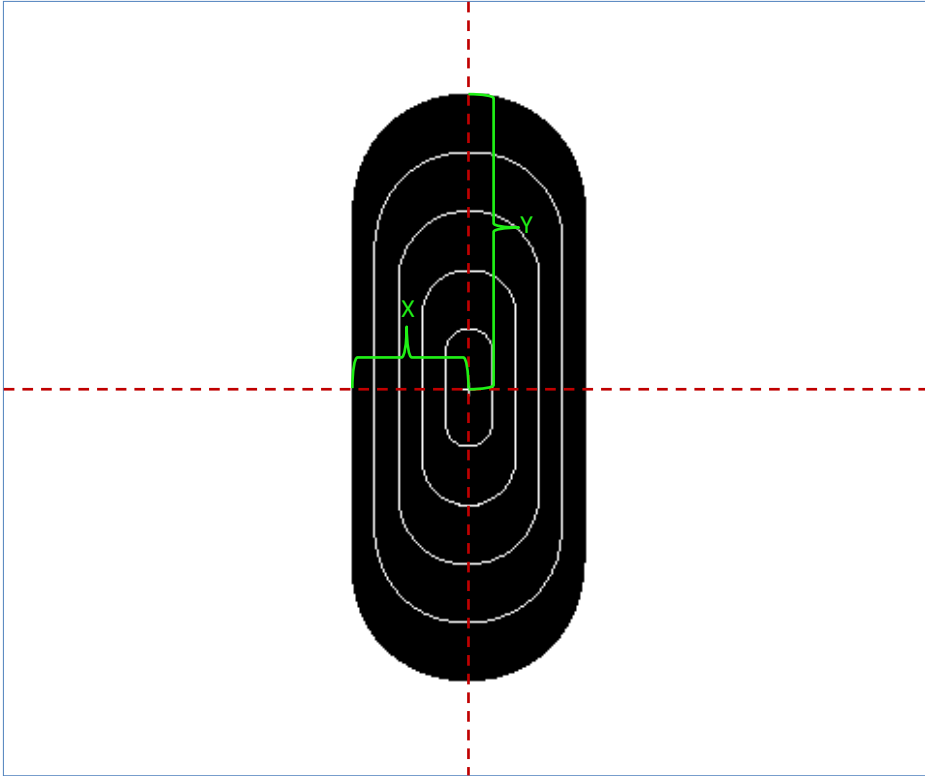

Diameter (mm)	Value

X	124 mm
Y	311 mm

Zoom levels

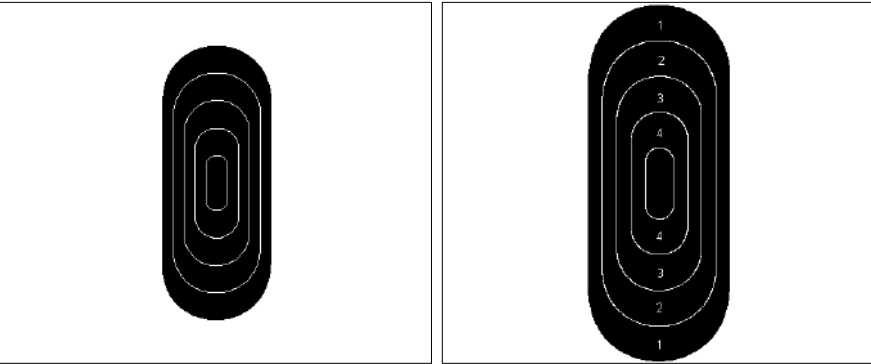

Technical data

Part No	735-0097-97-0109
Size	86 kb
Gauge (default)	8 mm
Aiming mark diameter	
Manufacture	
Manufacture Part No	

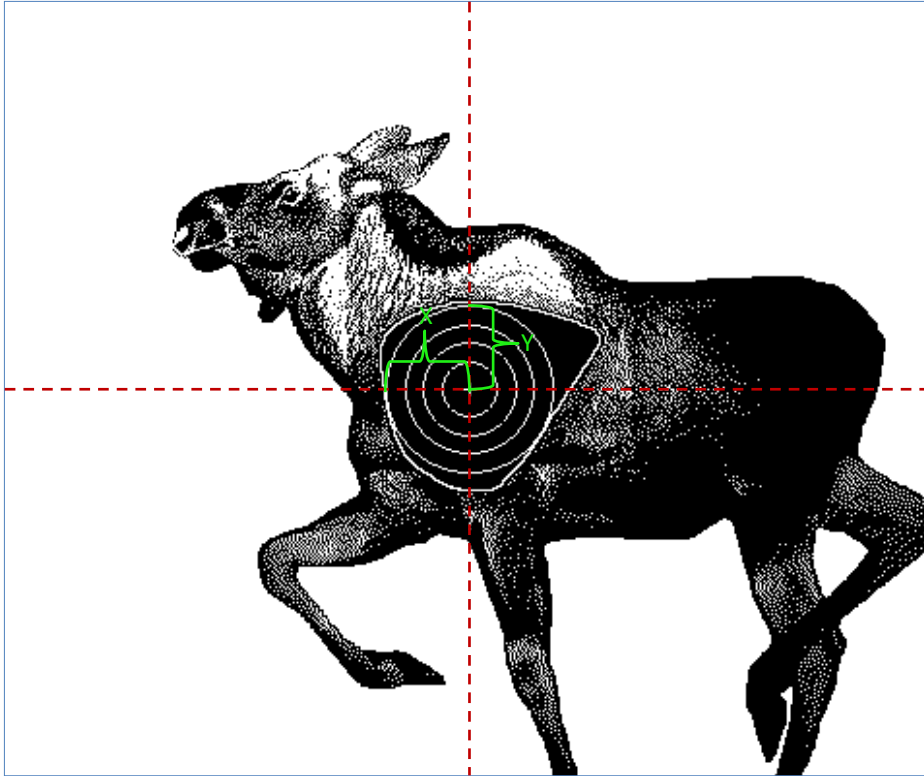

Diameter (mm)	Value
112	*
186	5
260	4
334	3

X	167 mm
Y	167 mm

Zoom levels

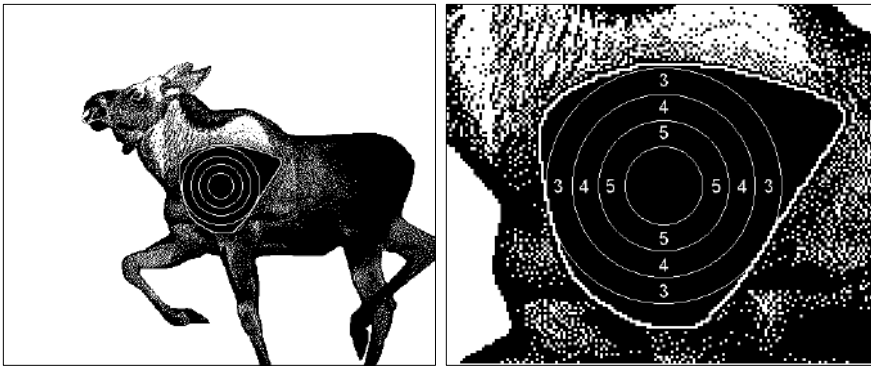

Technical data

Part No	735-0097-97-0110
Size	46 kb
Gauge (default)	8 mm
Aiming mark diameter	334 mm
Manufacture	
Manufacture Part No	

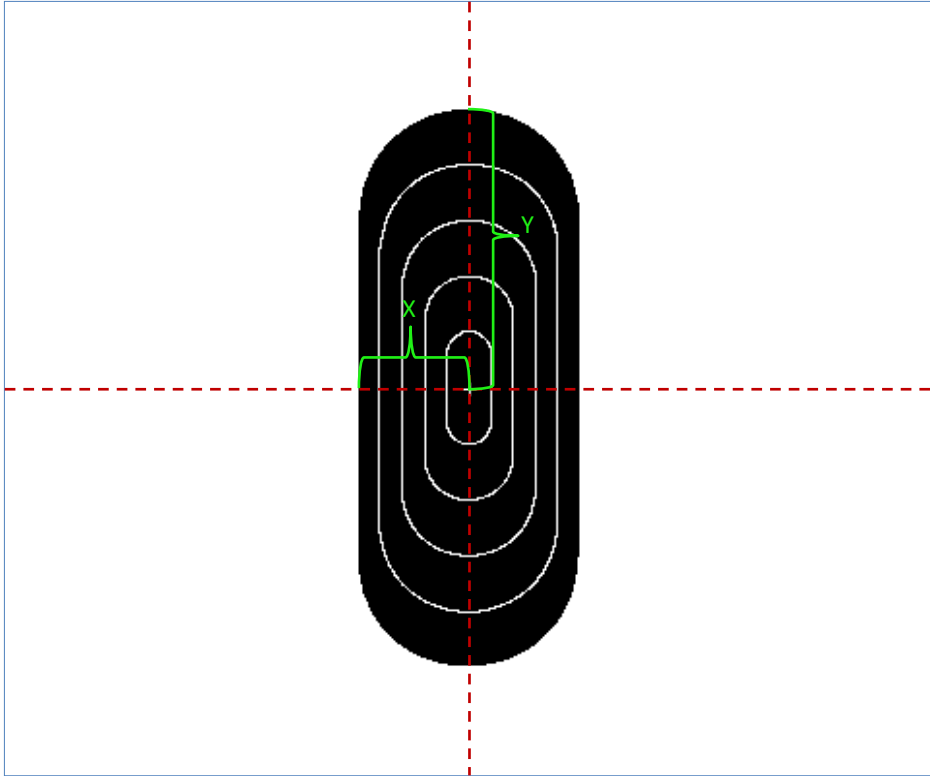

Diameter (mm)	Value

X	101 mm
Y	253 mm

Zoom levels

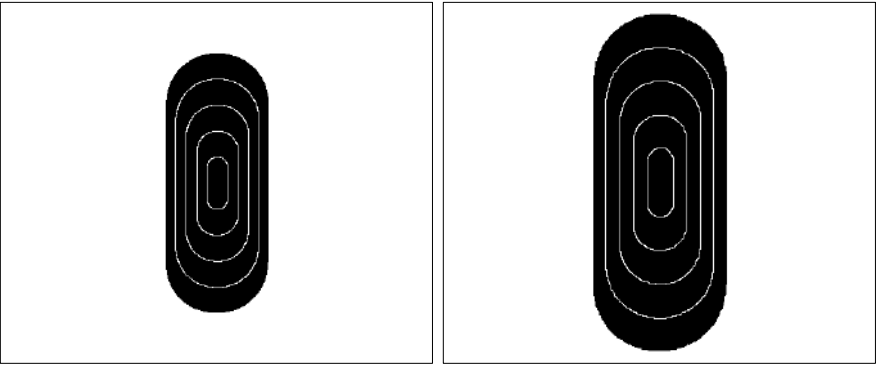

Technical data

Part No	735-0097-97-0111
Size	82 kb
Gauge (default)	8 mm
Aiming mark diameter	
Manufacture	
Manufacture Part No	

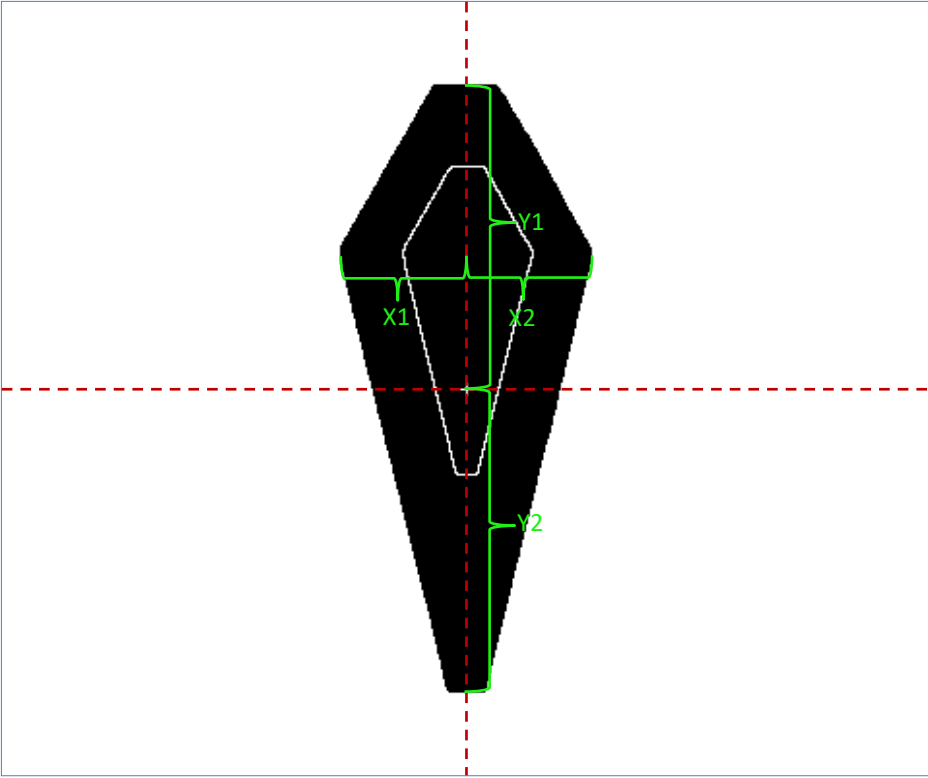

Diameter (mm)	Value

X1	148 mm	X2	148 mm
Y1	348 mm	Y2	348 mm

Zoom levels

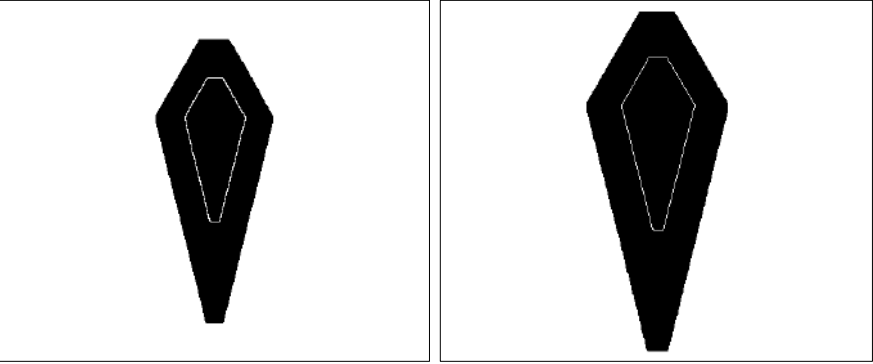

Technical data

Part No	735-0097-97-0112
Size	43 kb
Gauge (default)	8 mm
Aiming mark diameter	
Manufacture	
Manufacture Part No	

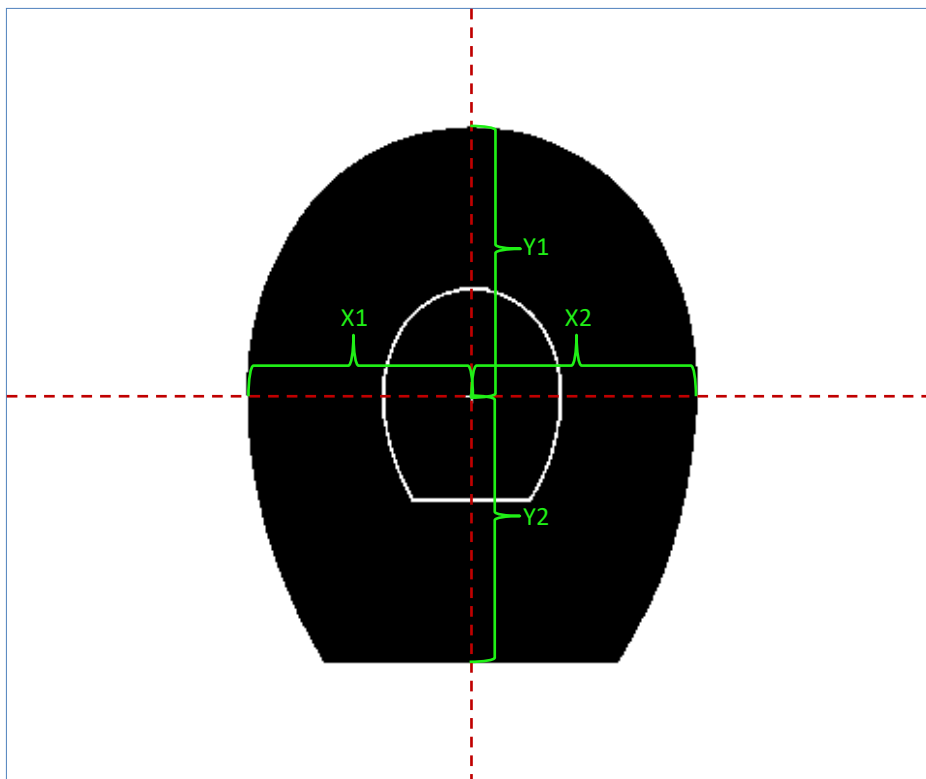

Diameter (mm)	Value

X1	127,5 mm	X2	127,5 mm
Y1	150,25 mm	Y2	150,25 mm

Zoom levels

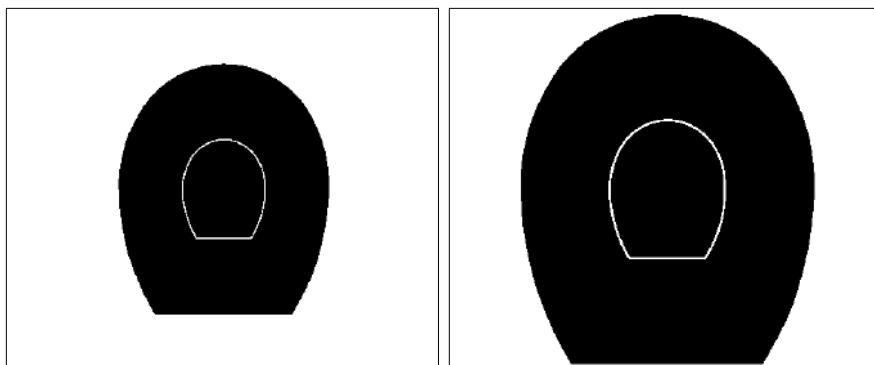

Technical data

Part No	735-0097-97-0113
Size	36 kb
Gauge (default)	8 mm
Aiming mark diameter	
Manufacture	
Manufacture Part No	

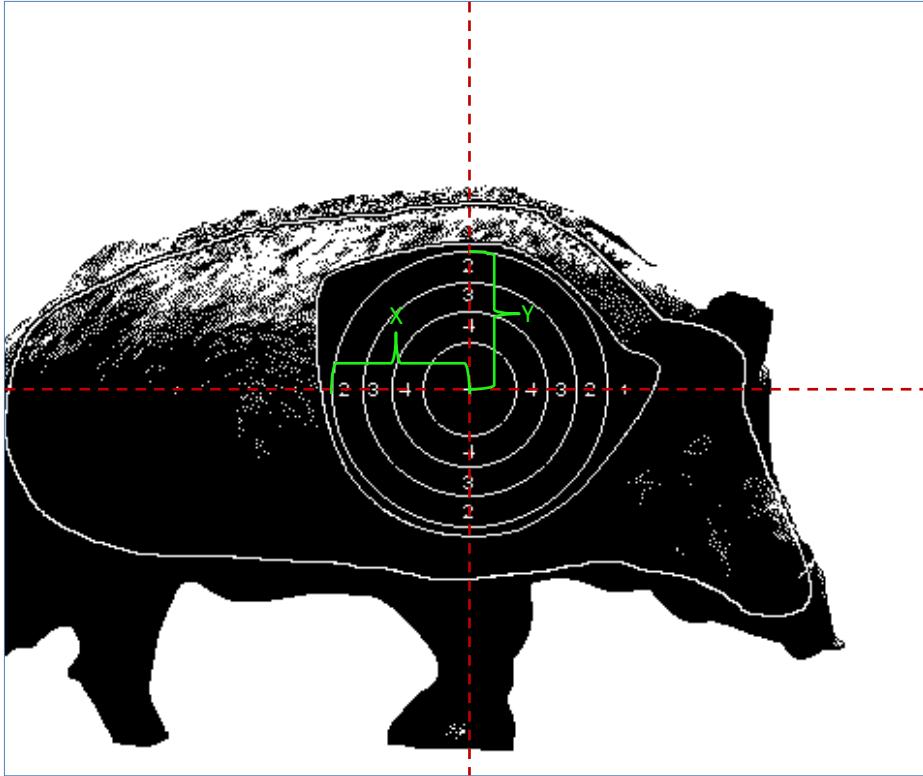

Diameter (mm)	Value
121	X
201	4
281	3
361	2

X	180,5 mm
Y	180,5 mm

Zoom levels

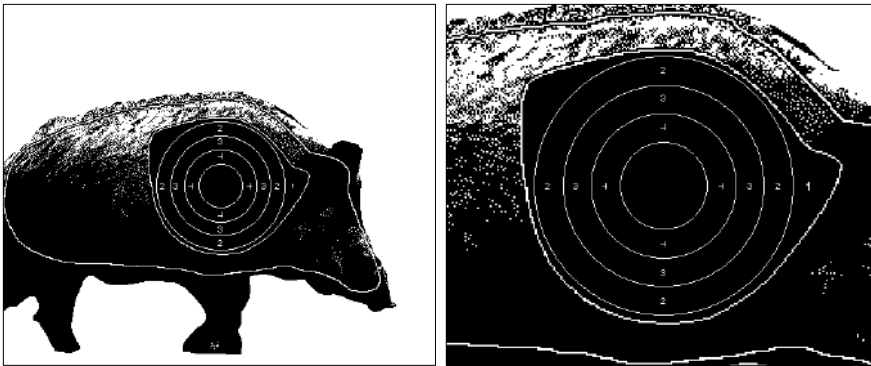

Technical data

Part No	735-0097-97-0114
Size	39 kb
Gauge (default)	8 mm
Aiming mark diameter	361 mm
Manufacture	
Manufacture Part No	

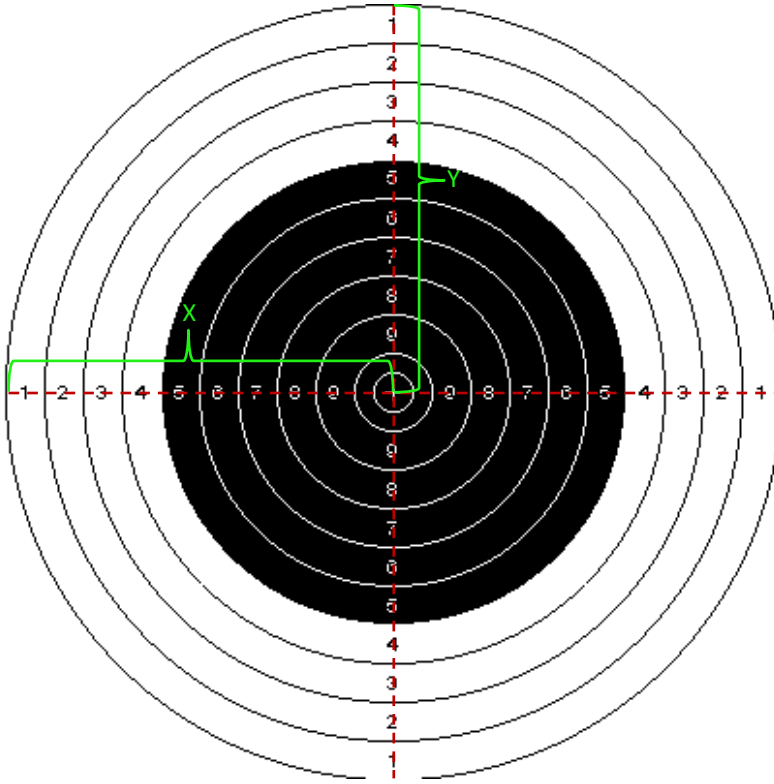

Diameter (mm)	Value
17	*
34	X
68	9
102	8
136	7
170	6
204	5
238	4
272	3
306	2
340	1

X	170 mm
Y	170 mm

Zoom levels

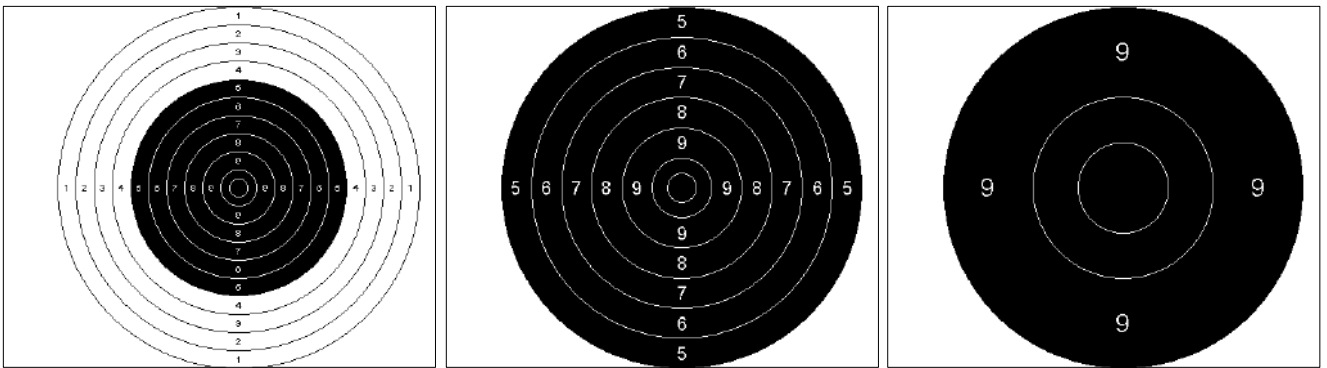

Technical data

Part No	735-0097-97-0115
Size	
Gauge (default)	8 mm
Aiming mark diameter	204 mm
Manufacture	
Manufacture Part No	

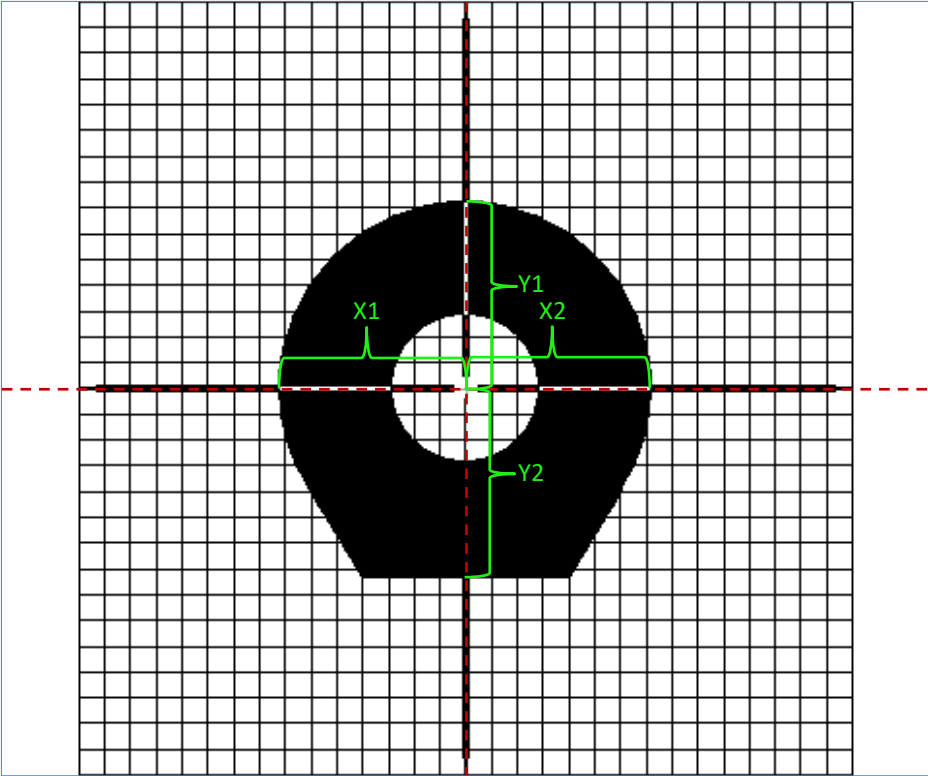

Diameter (mm)	Value

X1	72,4 mm	X2	72,4 mm
Y1	72,75 mm	Y2	72,75 mm

Zoom levels

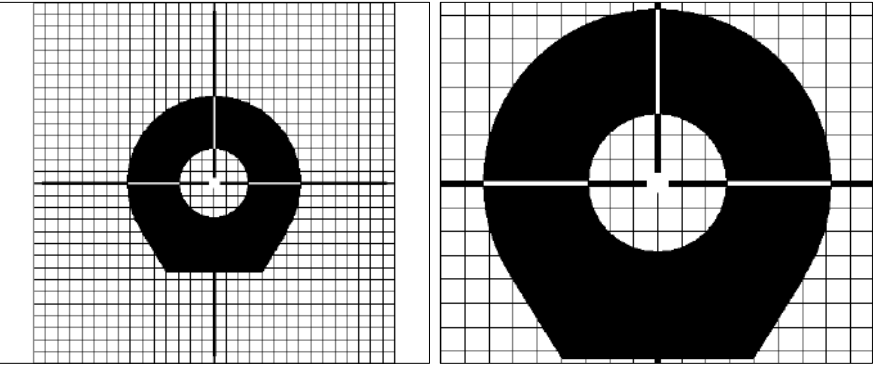

Technical data

Part No	735-0097-97-0116
Size	140 kb
Gauge (default)	8 mm
Aiming mark diameter	
Manufacture	DJV
Manufacture Part No	

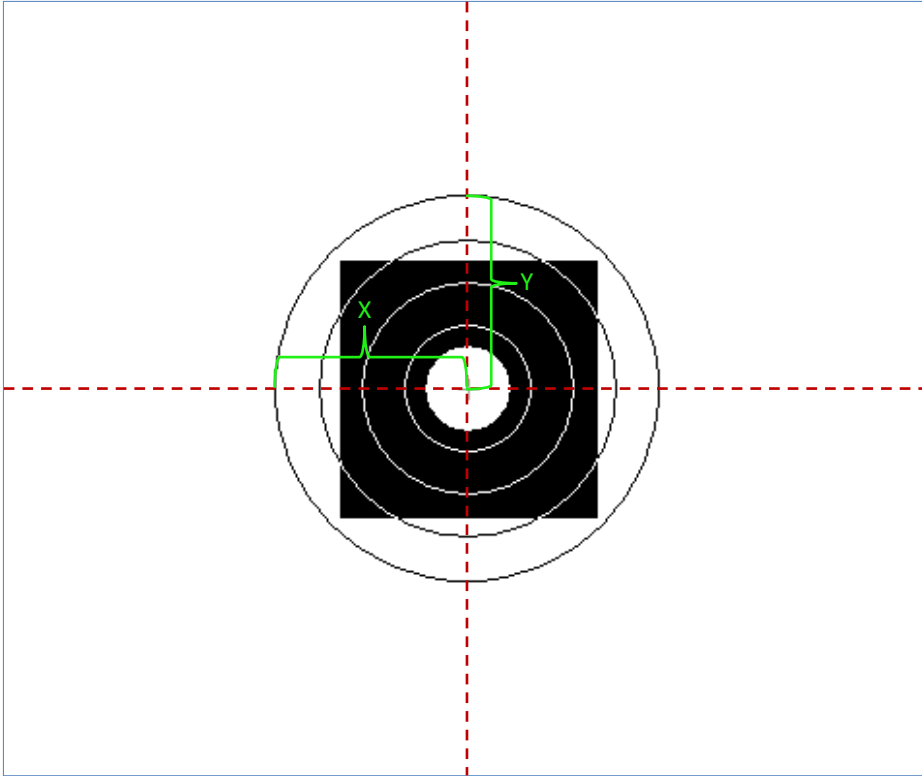

Diameter (mm)	Value
20	M
30	5
50	4
70	3
90	2

X	45 mm
Y	45 mm

Zoom levels

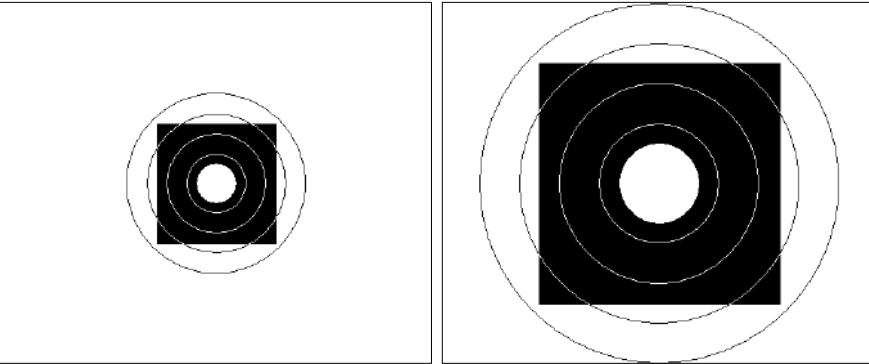

Technical data

Part No	735-0097-97-0117
Size	43 kb
Gauge (default)	8 mm
Aiming mark diameter	
Manufacture	
Manufacture Part No	

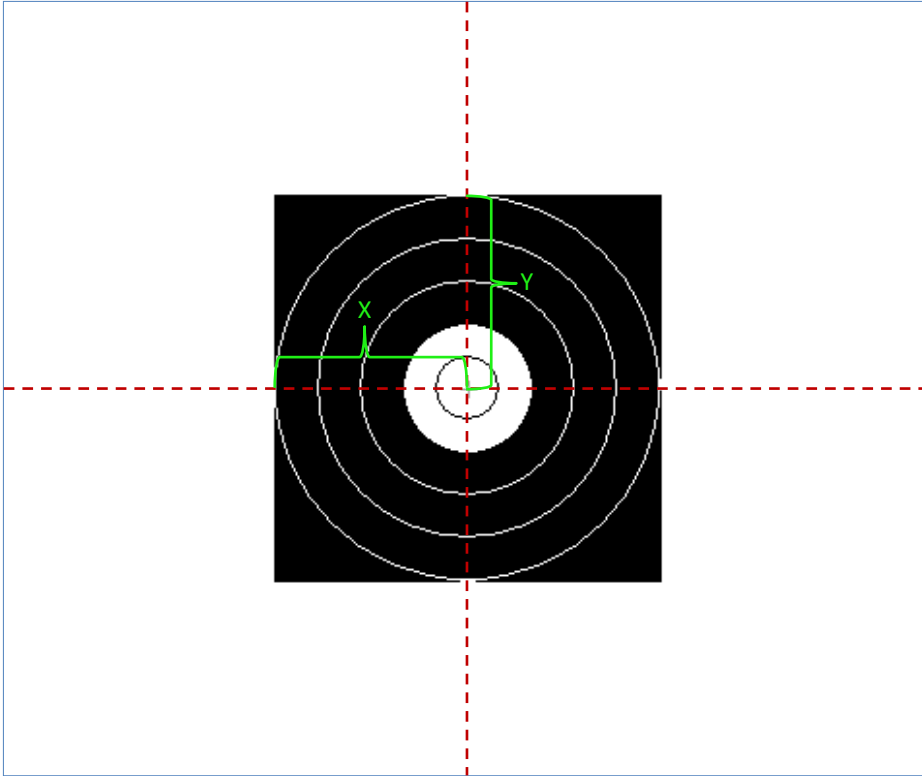

Diameter (mm)	Value
30	M
60	5
100	4
140	3
180	2

X	90 mm
Y	90 mm

Zoom levels

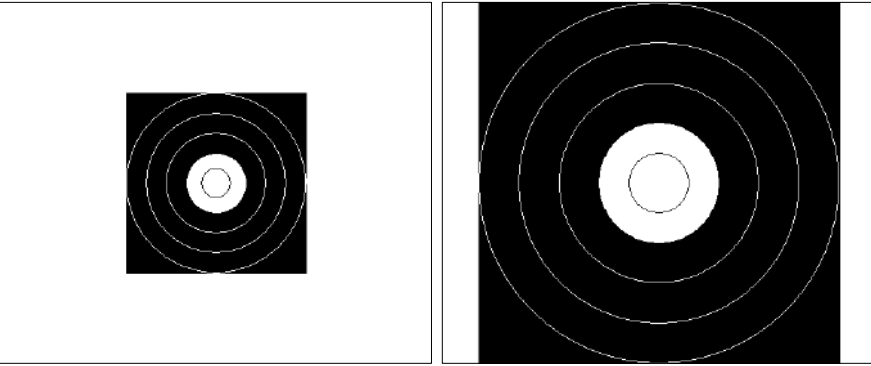

Technical data

Part No	735-0097-97-0118
Size	43 kb
Gauge (default)	8 mm
Aiming mark diameter	180 mm
Manufacture	
Manufacture Part No	

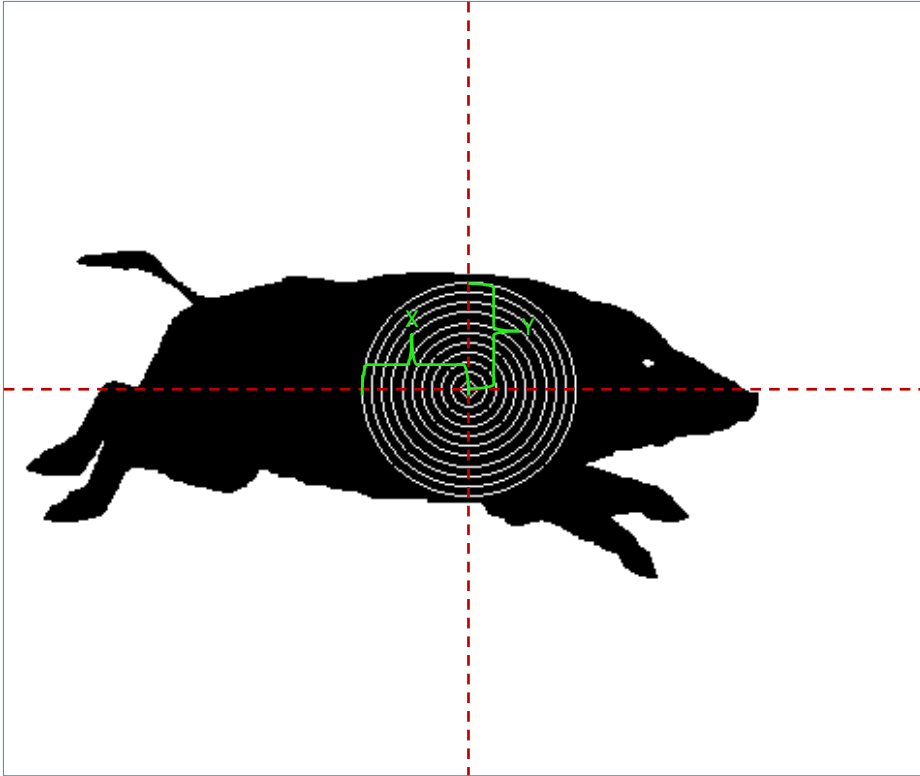

Diameter (mm)	Value
30	*
60	X
96	9
128	8
162	7
196	6
230	5
264	4
298	3
332	2
366	1

X	183 mm
Y	183 mm

Zoom levels

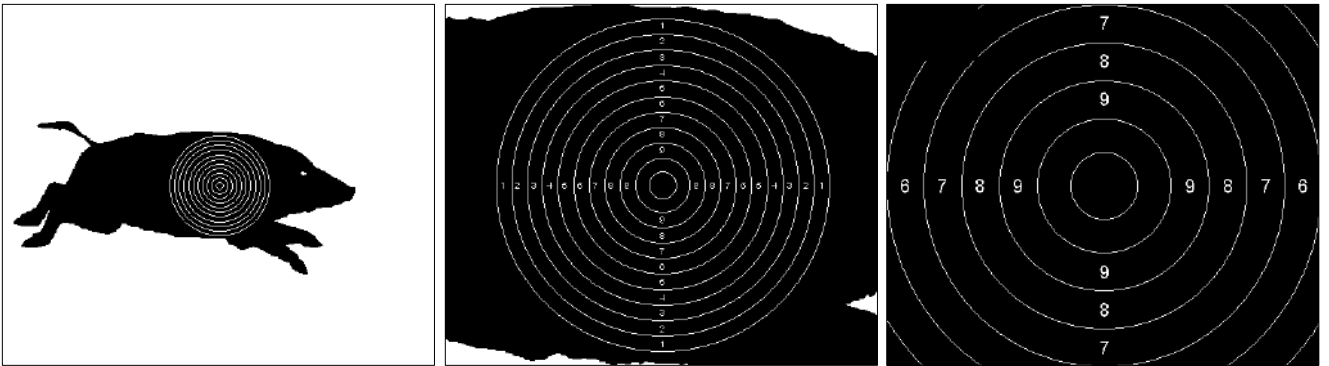

Technical data

Part No	735-0097-97-0119
Size	17 kb
Gauge (default)	5,6 mm
Aiming mark diameter	366 mm
Manufacture	
Manufacture Part No	

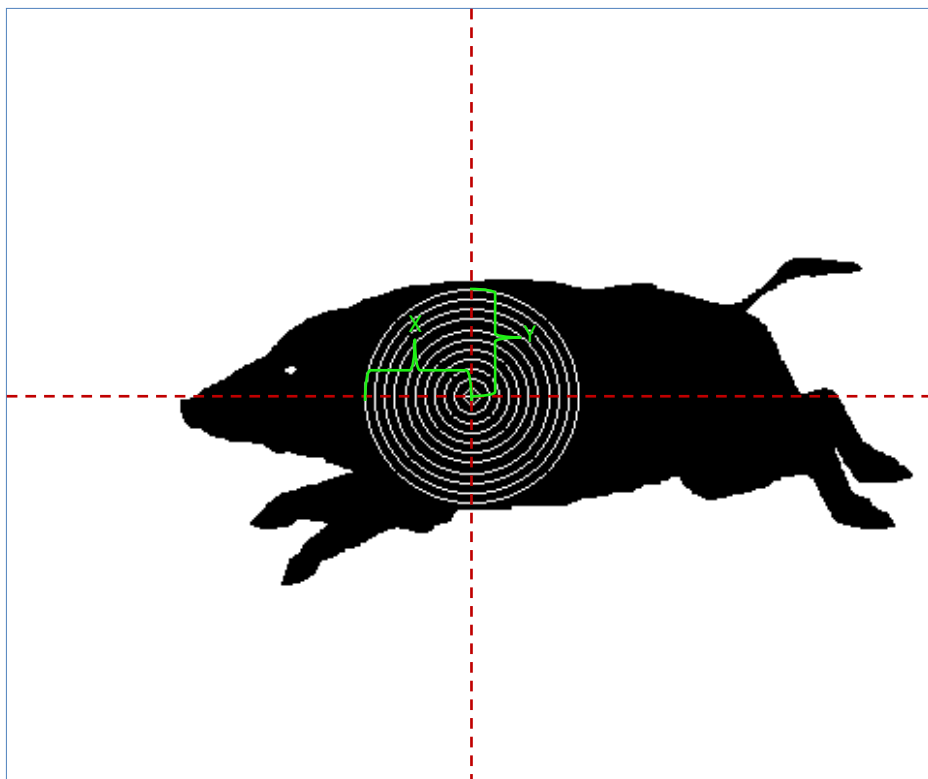

Diameter (mm)	Value
30	*
60	X
96	9
128	8
162	7
196	6
230	5
264	4
298	3
332	2
366	1

X	183 mm
Y	183 mm

Zoom levels

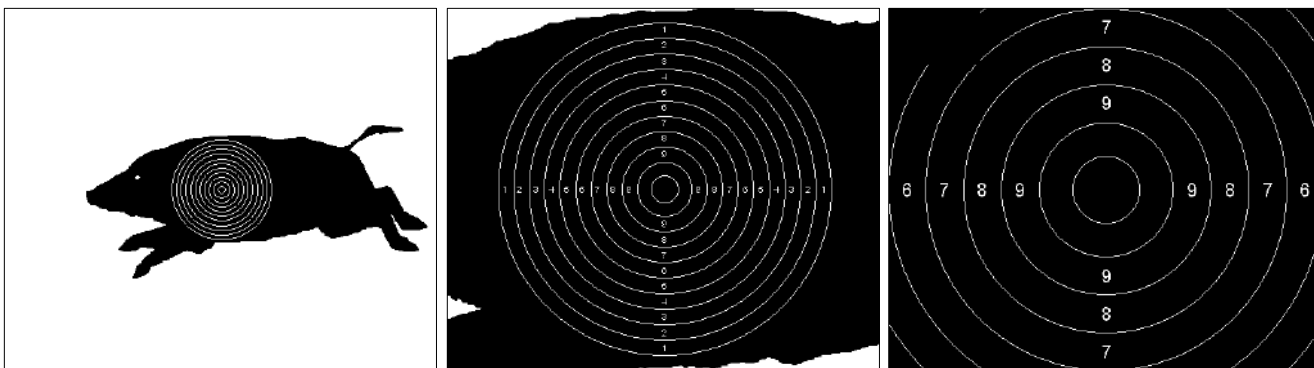

Technical data

Part No	735-0097-97-0120
Size	17 kb
Gauge (default)	5,6 mm
Aiming mark diameter	366 mm
Manufacture	
Manufacture Part No	

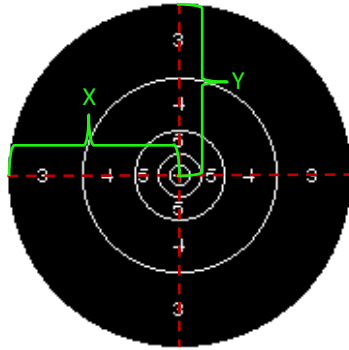

Diameter (mm)	Value
35	X
70	V
140	5
300	4
535	3

X	267,5 mm
Y	267,5 mm

Zoom levels

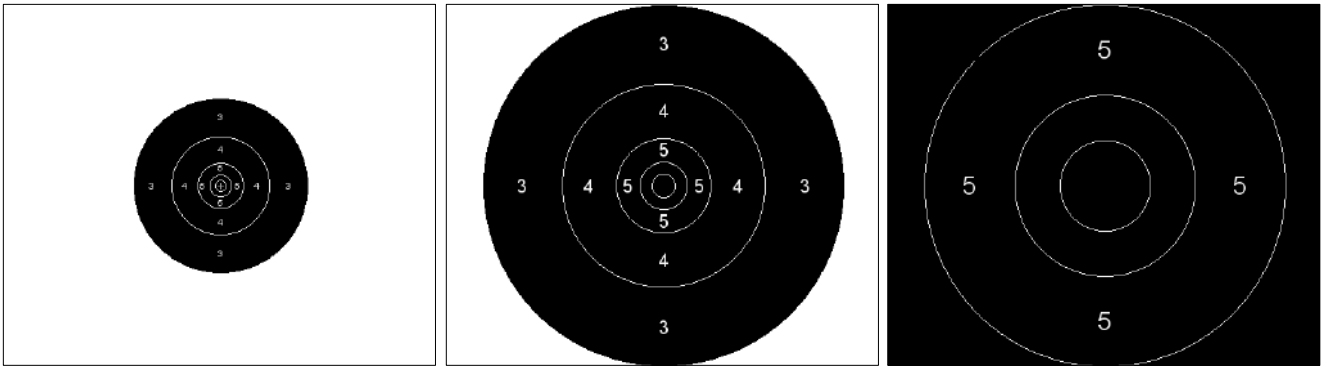

Technical data

Part No	735-0097-97-0121
Size	18 kb
Gauge (default)	7,62 mm
Aiming mark diameter	535 mm
Manufacture	
Manufacture Part No	

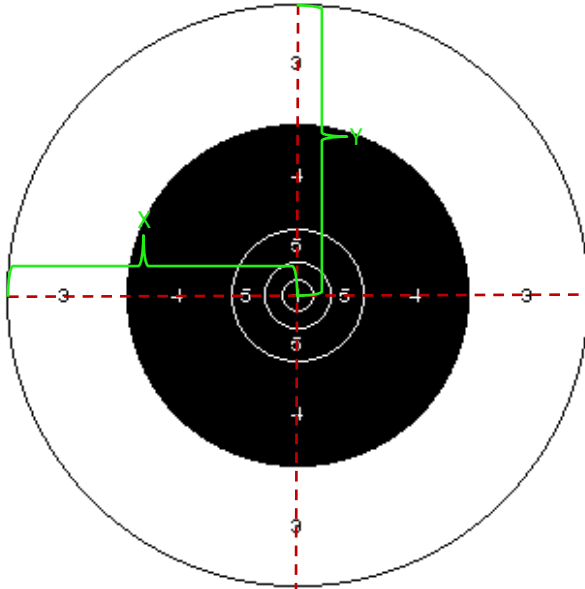

Diameter (mm)	Value
51	X
102	V
204	5
535	4
900	3

X	450 mm
Y	450 mm

Zoom levels

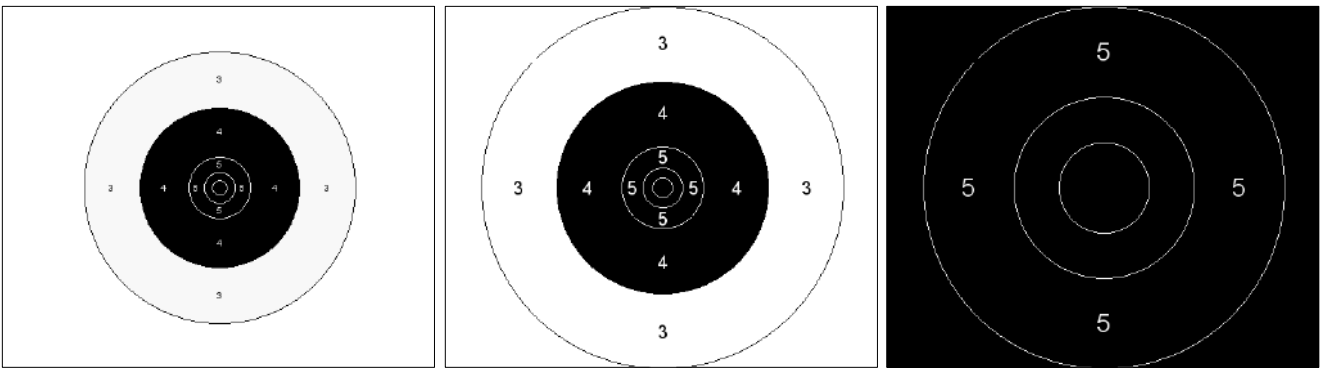

Technical data

Part No	735-0097-97-0122
Size	18 kb
Gauge (default)	7,62 mm
Aiming mark diameter	535 mm
Manufacture	
Manufacture Part No	

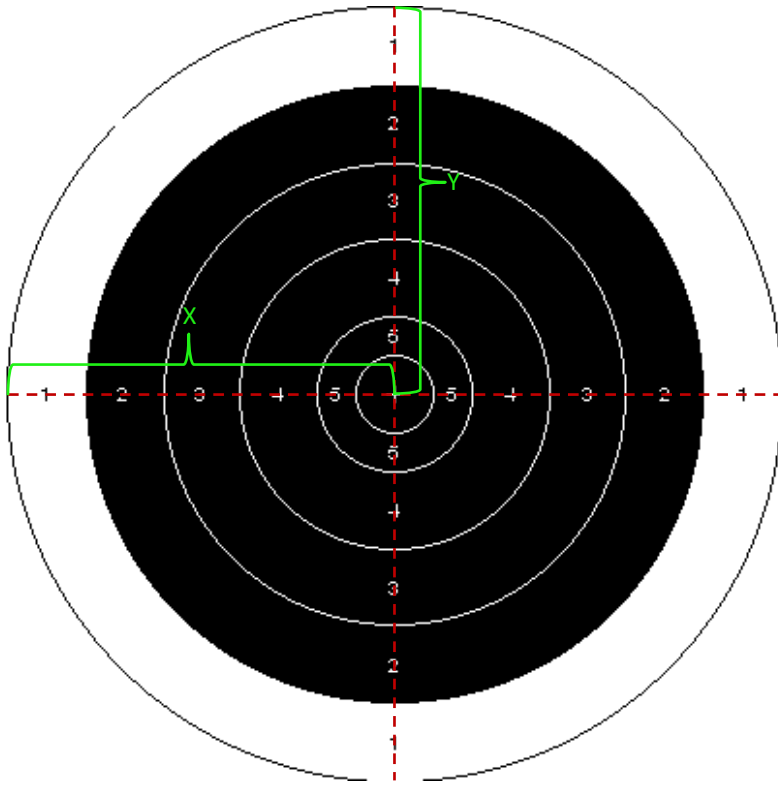

Diameter (mm)	Value
25,4	V
50,8	5
101,6	4
152,4	3
203,2	2
254	1

X	127 mm
Y	127 mm

Zoom levels



Technical data

Part No	735-0097-97-0123
Size	2 kb
Gauge (default)	8 mm
Aiming mark diameter	203,2 mm
Manufacture	
Manufacture Part No	

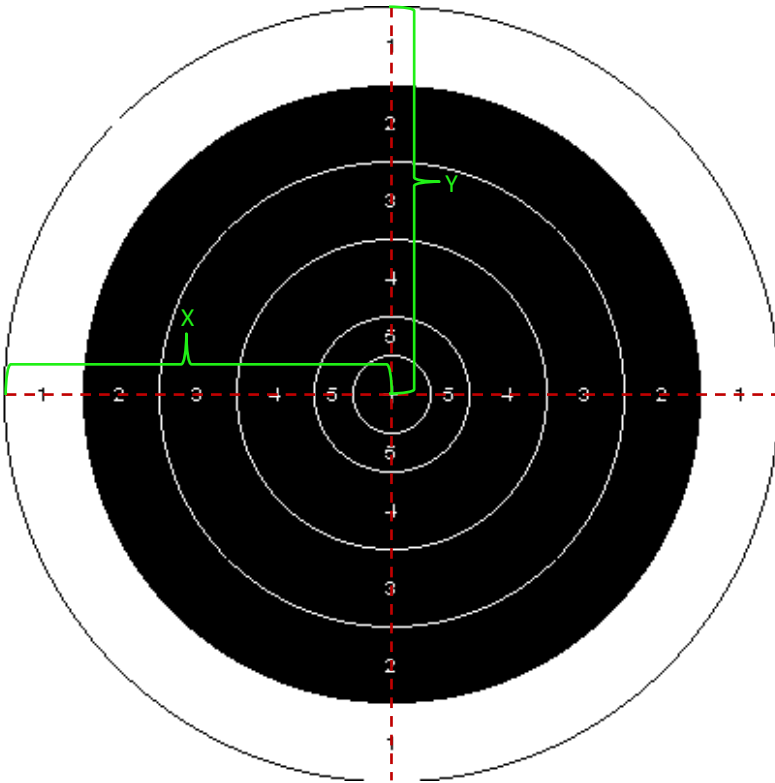

Diameter (mm)	Value
38,1	V
66,2	5
152,2	4
228,6	3
304,8	2
381	1

X	190,5 mm
Y	190,5 mm

Zoom levels

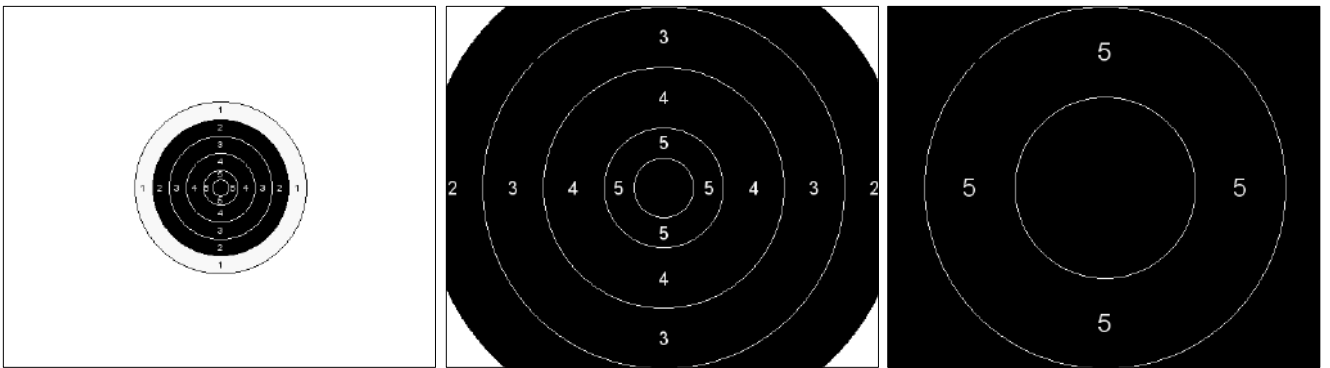

Technical data

Part No	735-0097-97-0124
Size	2 kb
Gauge (default)	8 mm
Aiming mark diameter	304,8 mm
Manufacture	
Manufacture Part No	

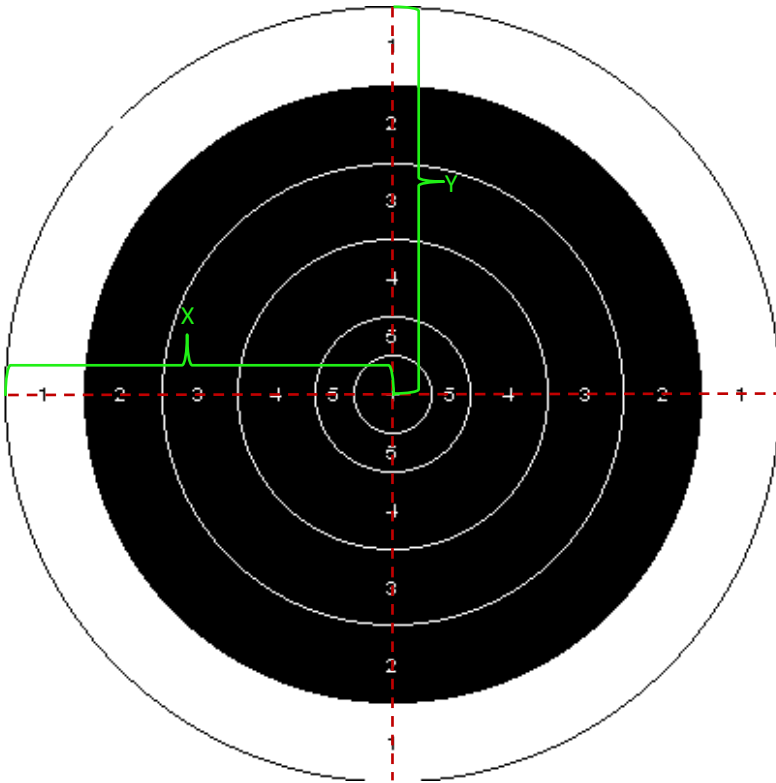

Diameter (mm)	Value
50,8	V
101,6	5
203,2	4
304,8	3
406,4	2
508	1

X	254 mm
Y	254 mm

Zoom levels

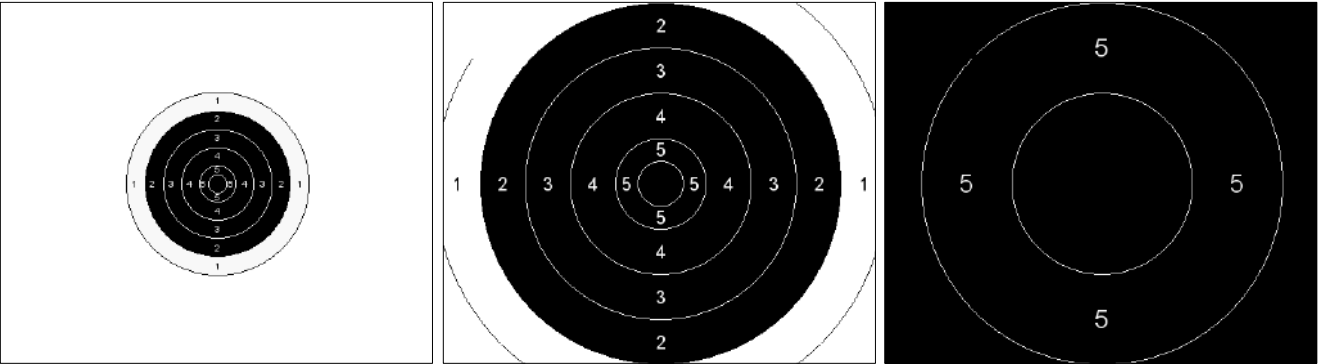

Technical data

Part No	735-0097-97-0125
Size	2 kb
Gauge (default)	8 mm
Aiming mark diameter	406,4 mm
Manufacture	
Manufacture Part No	

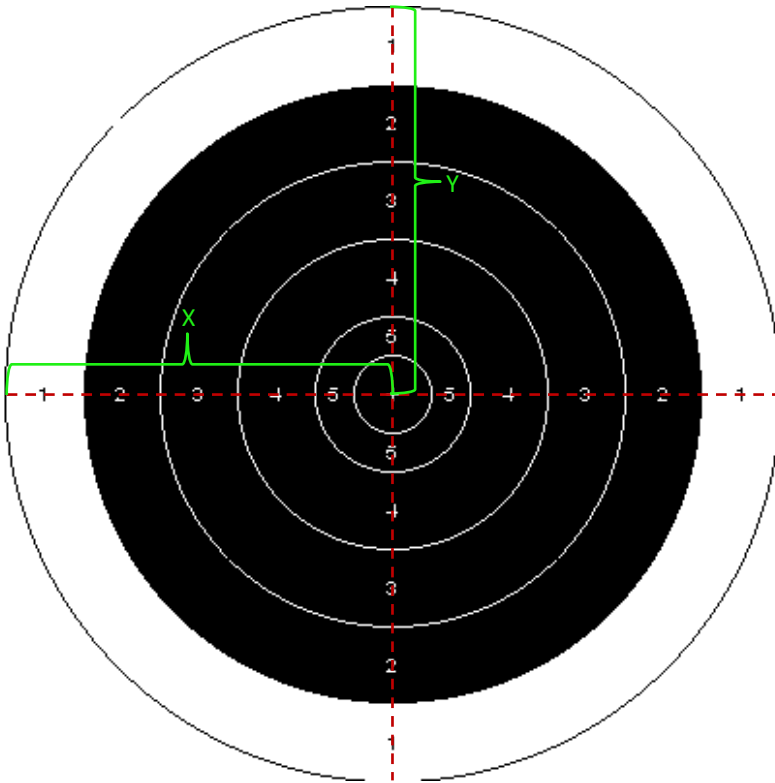

Diameter (mm)	Value
63,5	V
127	5
254	4
281	3
508	2
635	1

X	317,5 mm
Y	317,5 mm

Zoom levels

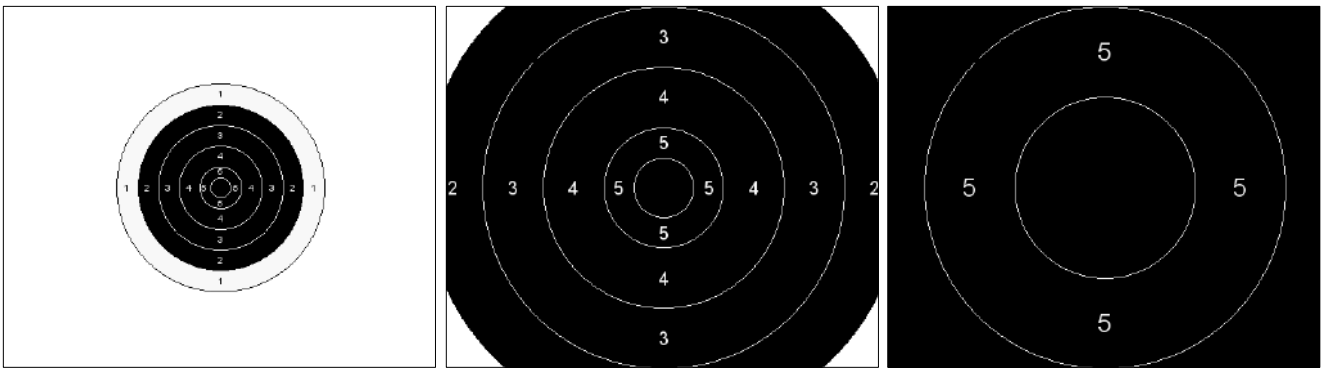

Technical data

Part No	735-0097-97-0126
Size	2 kb
Gauge (default)	8 mm
Aiming mark diameter	508 mm
Manufacture	
Manufacture Part No	

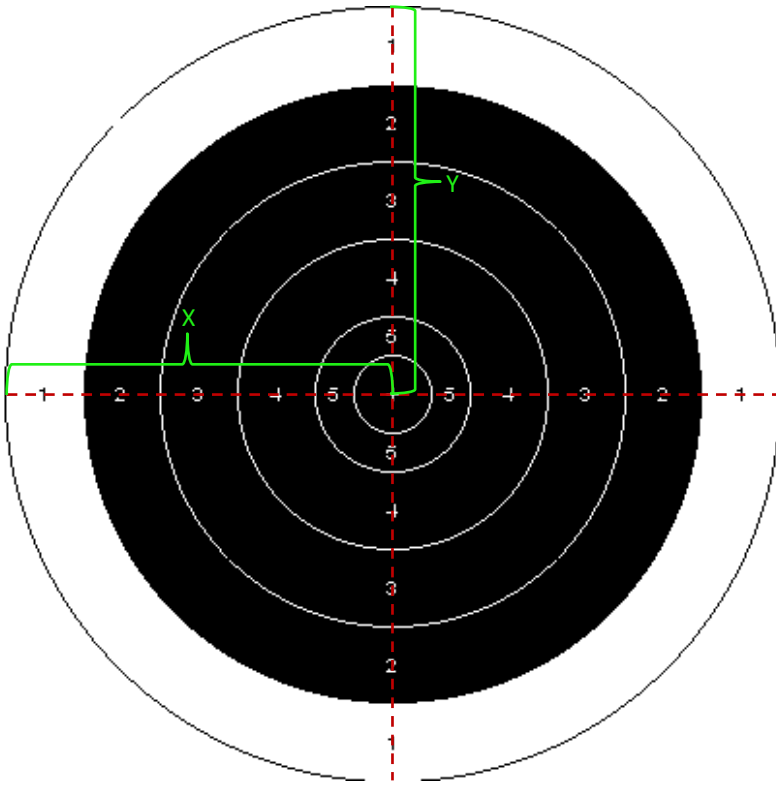

Diameter (mm)	Value
76,2	V
152,4	5
304,8	4
457,2	3
609,6	2
762	1

X	381 mm
Y	381 mm

Zoom levels

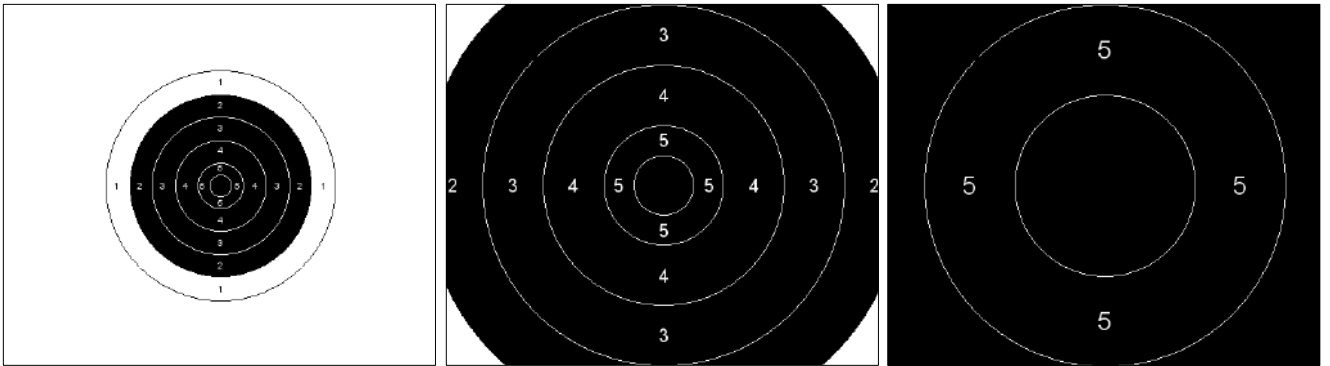

Technical data

Part No	735-0097-97-0127
Size	2 kb
Gauge (default)	8 mm
Aiming mark diameter	609,6 mm
Manufacture	
Manufacture Part No	

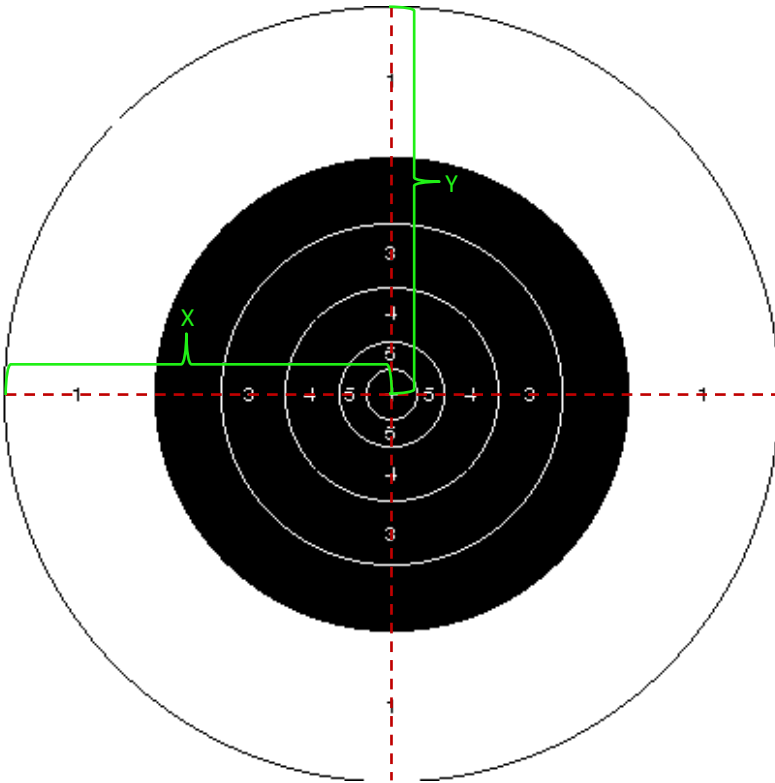

Diameter (mm)	Value
127	V
254	5
406,4	4
812,8	3
1117,6	2
1828,8	1

X	914,4 mm
Y	914,4 mm

Zoom levels



Technical data

Part No	735-0097-97-0128
Size	2 kb
Gauge (default)	8 mm
Aiming mark diameter	1117,6 mm
Manufacture	
Manufacture Part No	

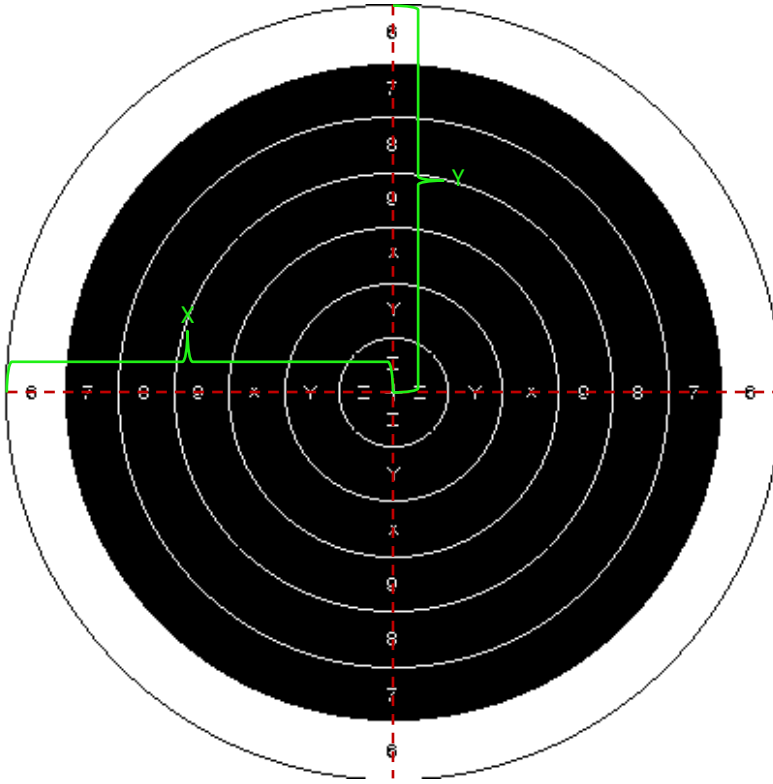

Diameter (mm)	Value
24	Z
48	Y
72	X
96	9
120	8
142	7
169	6

X	84,5 mm
Y	84,5 mm

Zoom levels

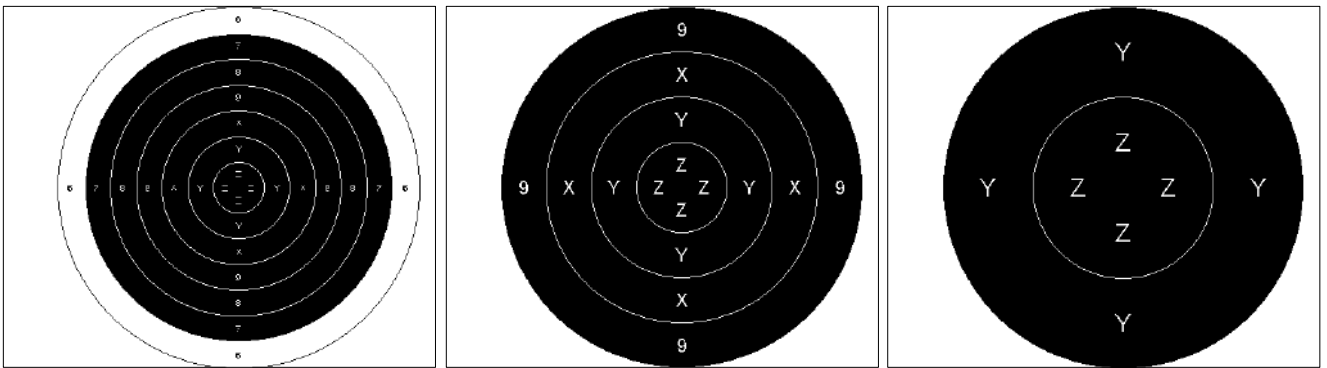

Technical data

Part No	735-0097-97-0129
Size	N/A
Gauge (default)	5,6 mm
Aiming mark diameter	144 mm
Manufacture	
Manufacture Part No	

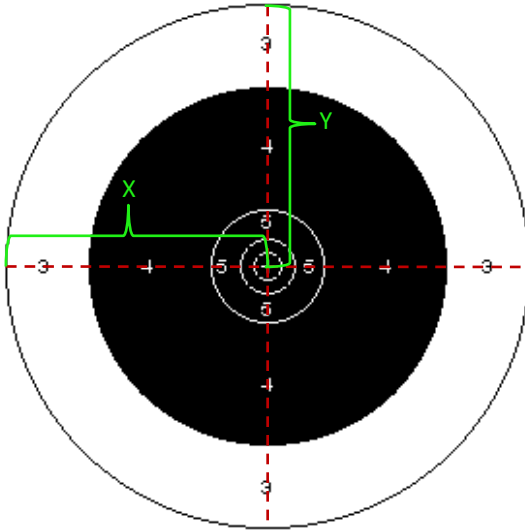

Diameter (mm)	Value
67	X
134	V
268	5
840	4
1220	3

X	610 mm
Y	610 mm

Zoom levels

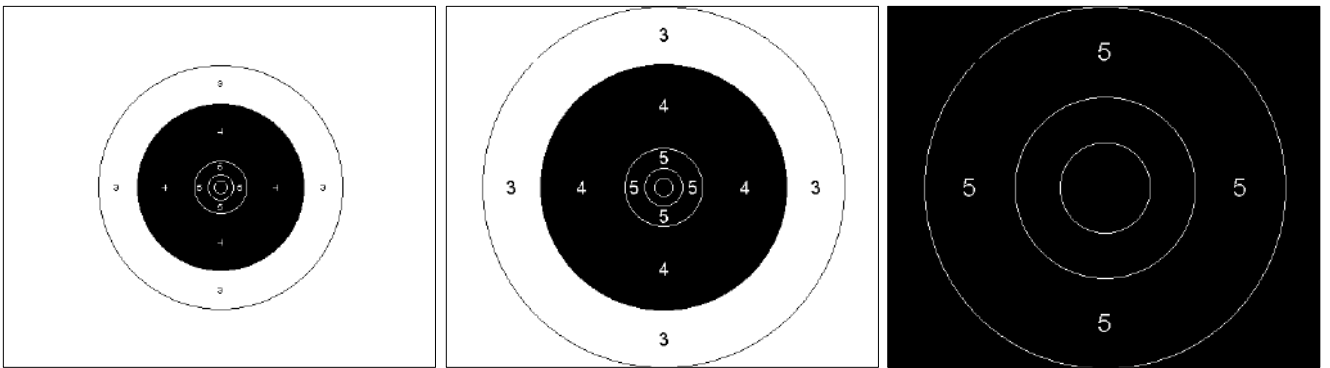

Technical data

Part No	735-0097-97-0130
Size	18 kb
Gauge (default)	7,62 mm
Aiming mark diameter	840 mm
Manufacture	
Manufacture Part No	

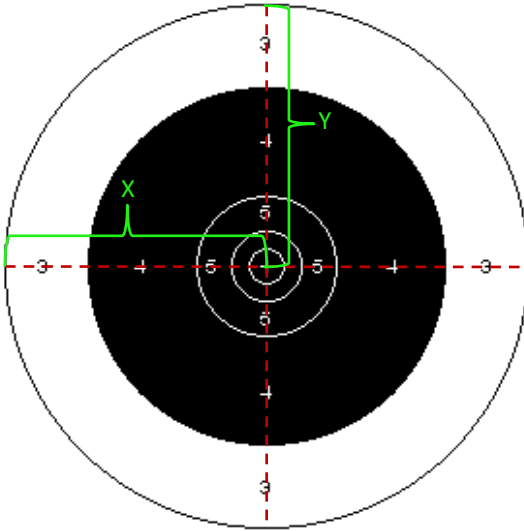

Diameter (mm)	Value
82,5	X
165	V
330	5
840	4
1220	3

X	610 mm
Y	610 mm

Zoom levels

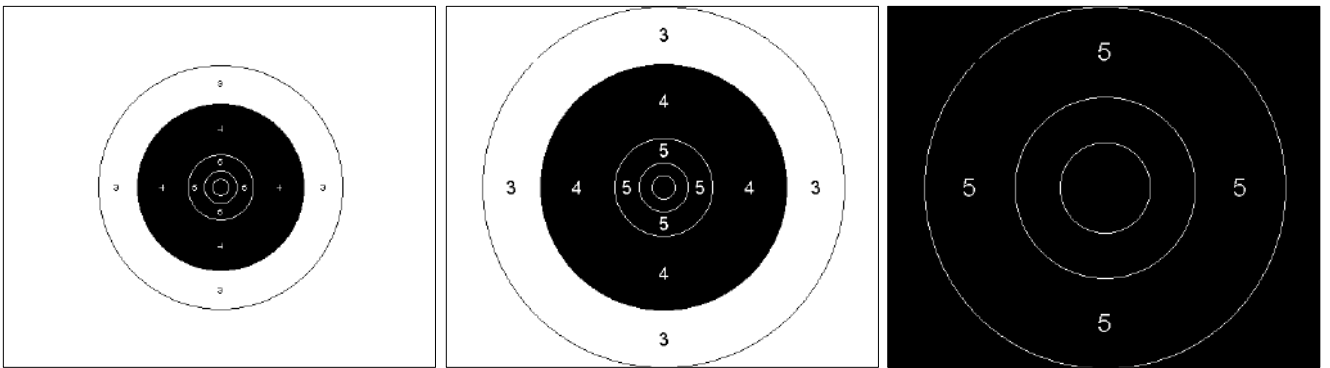

Technical data

Part No	735-0097-97-0131
Size	18 kb
Gauge (default)	7,62 mm
Aiming mark diameter	840 mm
Manufacture	
Manufacture Part No	

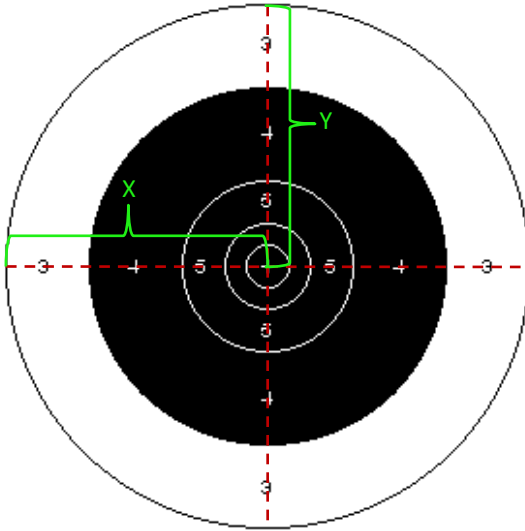

Diameter (mm)	Value
100	X
200	V
400	5
840	4
1220	3

X	610 mm
Y	610 mm

Zoom levels

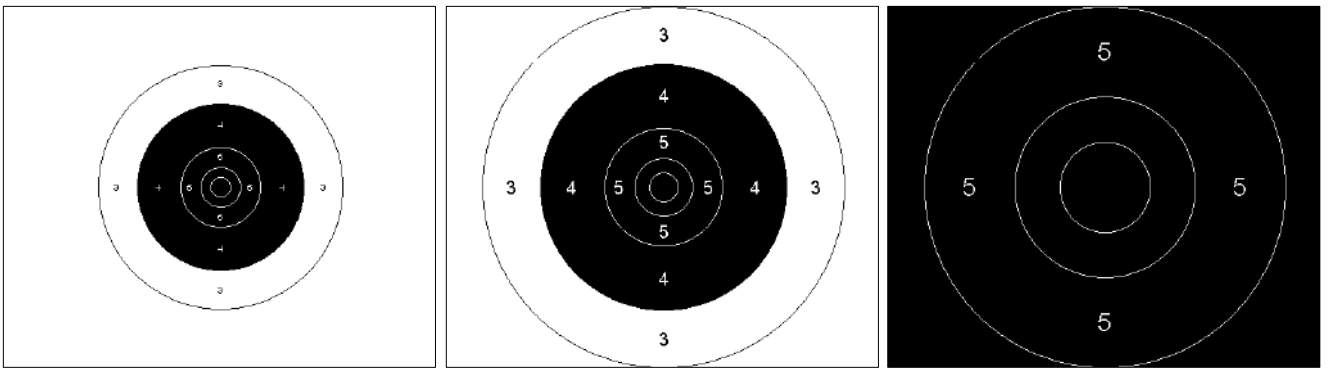

Technical data

Part No	735-0097-97-0132
Size	18 kb
Gauge (default)	7,62 mm
Aiming mark diameter	840 mm
Manufacture	
Manufacture Part No	

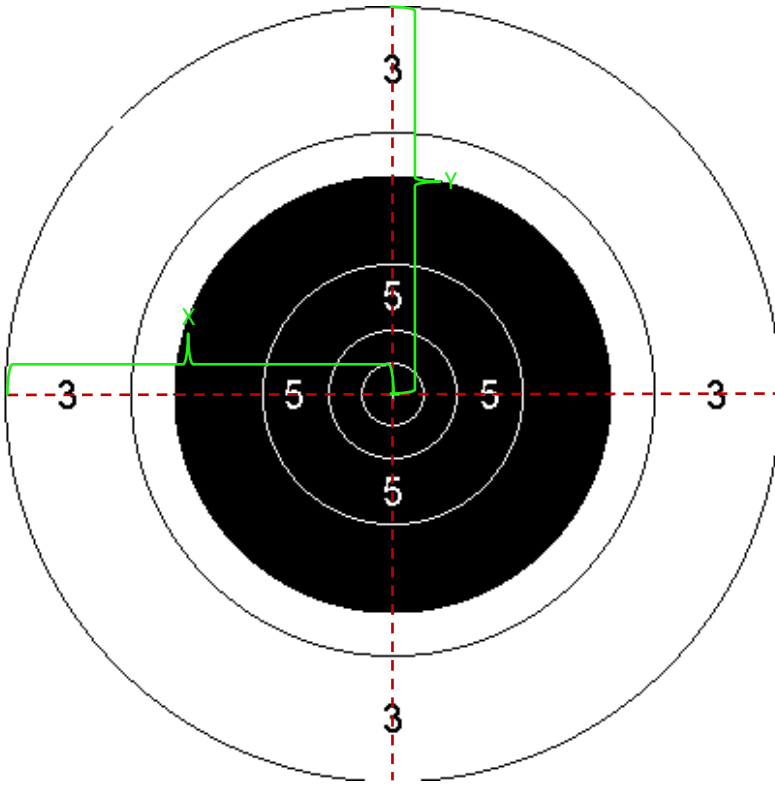

Diameter (mm)	Value
152,5	X
305	V
610	5
1220	4
1800	3

X	900 mm
Y	900 mm

Zoom levels

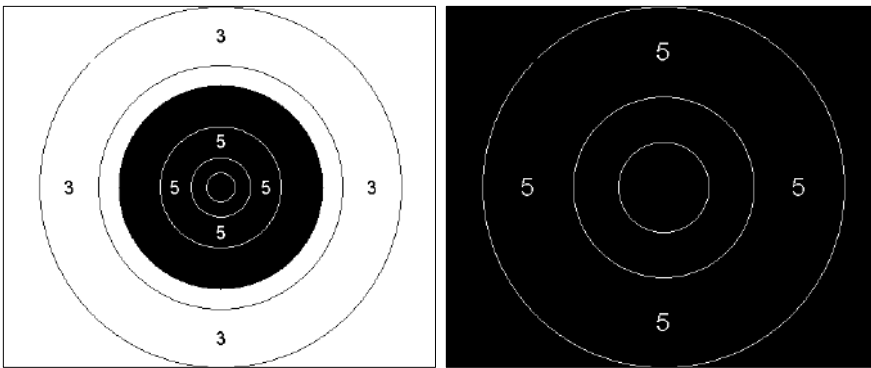

Technical data

Part No	735-0097-97-0133
Size	16 kb
Gauge (default)	7,62 mm
Aiming mark diameter	1020 mm
Manufacture	
Manufacture Part No	

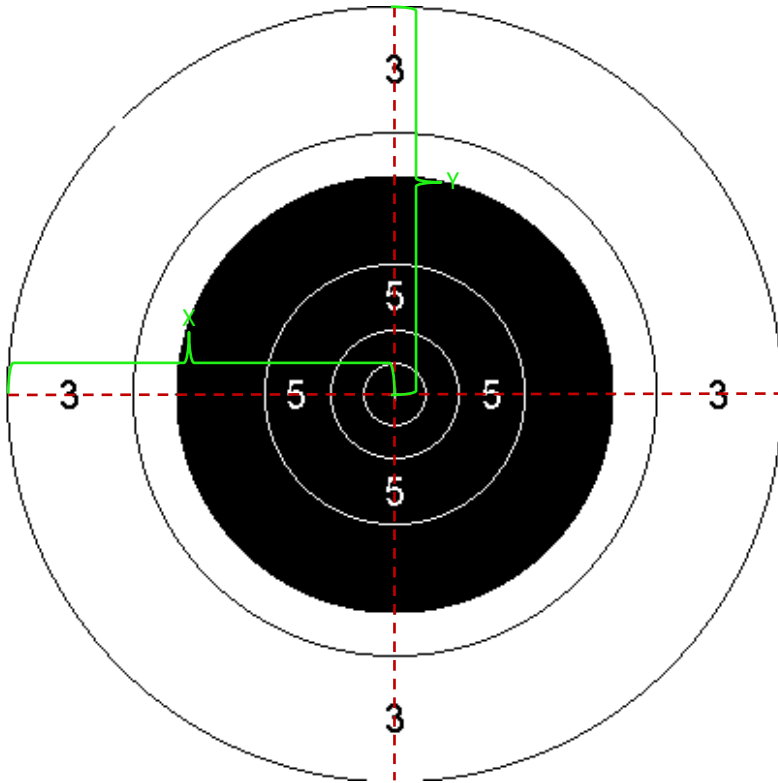

Diameter (mm)	Value
152,5	X
305	V
610	5
1220	4
1800	3

X	900 mm
Y	900 mm

Zoom levels

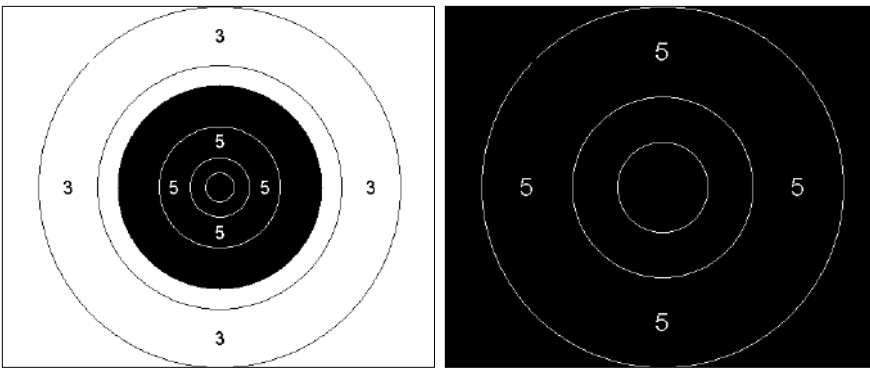

Technical data

Part No	735-0097-97-0134
Size	16 kb
Gauge (default)	7,62 mm
Aiming mark diameter	1020 mm
Manufacture	
Manufacture Part No	

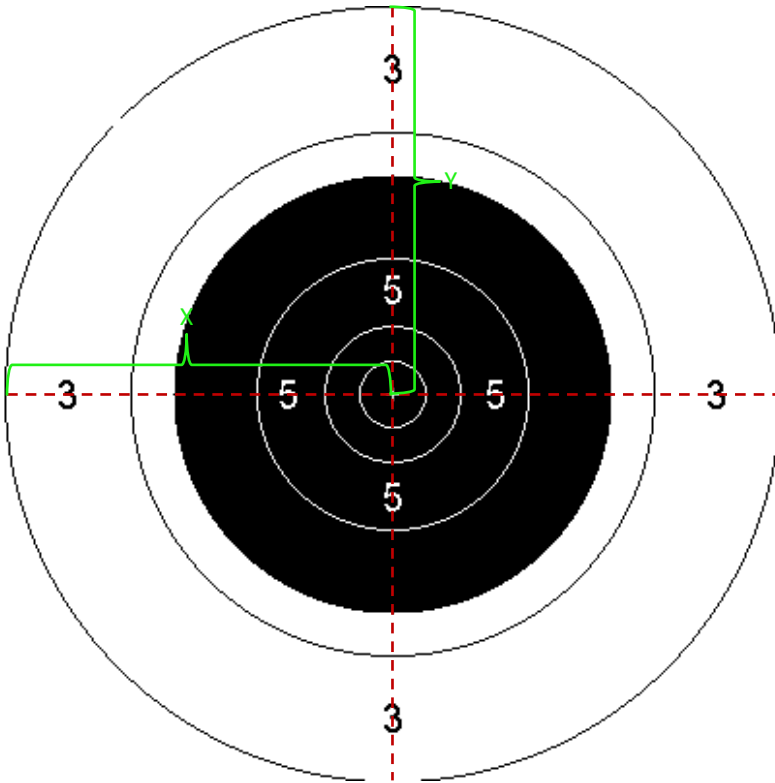

Diameter (mm)	Value
160	X
320	V
635	5
1220	4
1800	3

X	900 mm
Y	900 mm

Zoom levels

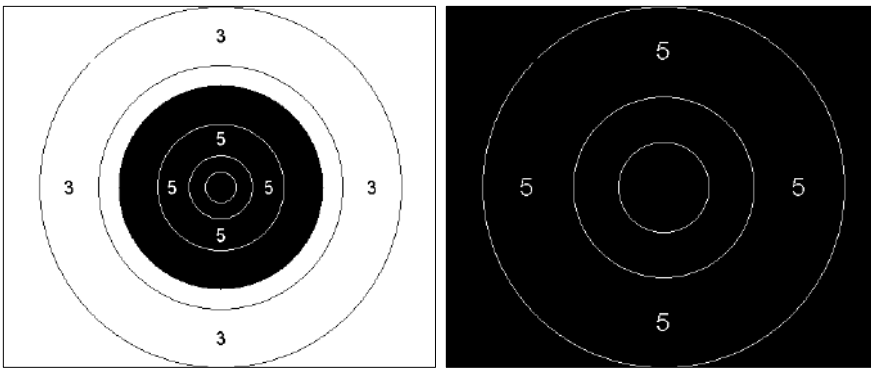

Technical data

Part No	735-0097-97-0135
Size	16 kb
Gauge (default)	7,62 mm
Aiming mark diameter	1020 mm
Manufacture	
Manufacture Part No	

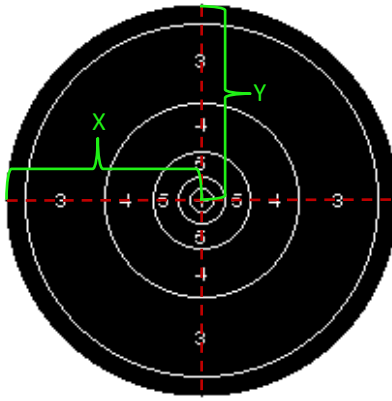

Diameter (mm)	Value
38	X
76	V
152	5
305	4
550	3

X	275 mm
Y	275 mm

Zoom levels

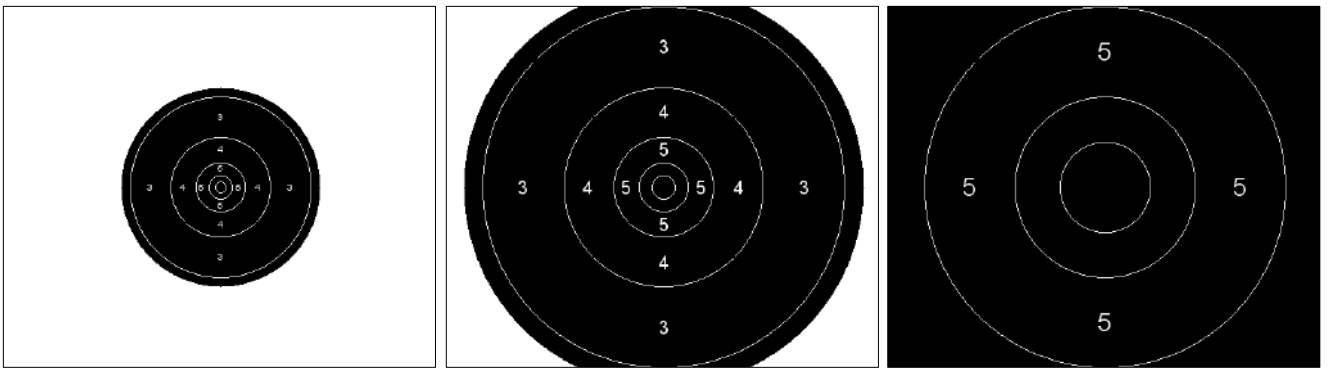

Technical data

Part No	735-0097-97-0136
Size	18 kb
Gauge (default)	7,62 mm
Aiming mark diameter	610 mm
Manufacture	
Manufacture Part No	

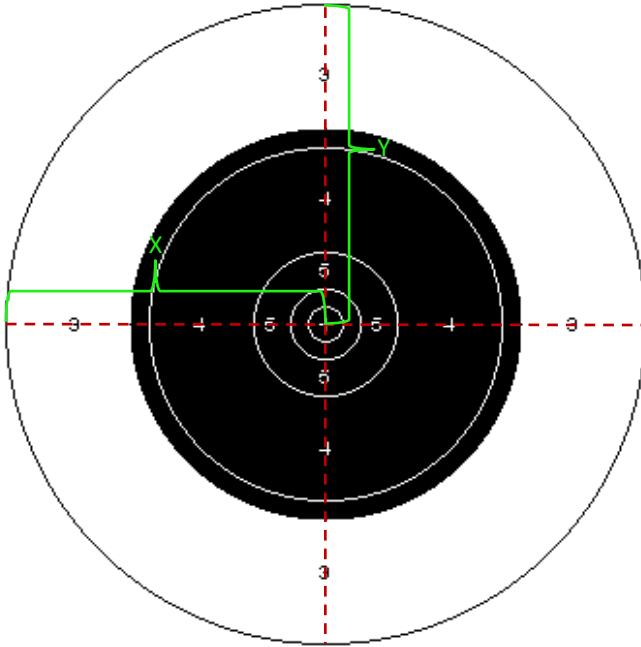

Diameter (mm)	Value
55,5	X
111	V
222	5
550	4
995	3

X	497,5 mm
Y	497,5 mm

Zoom levels

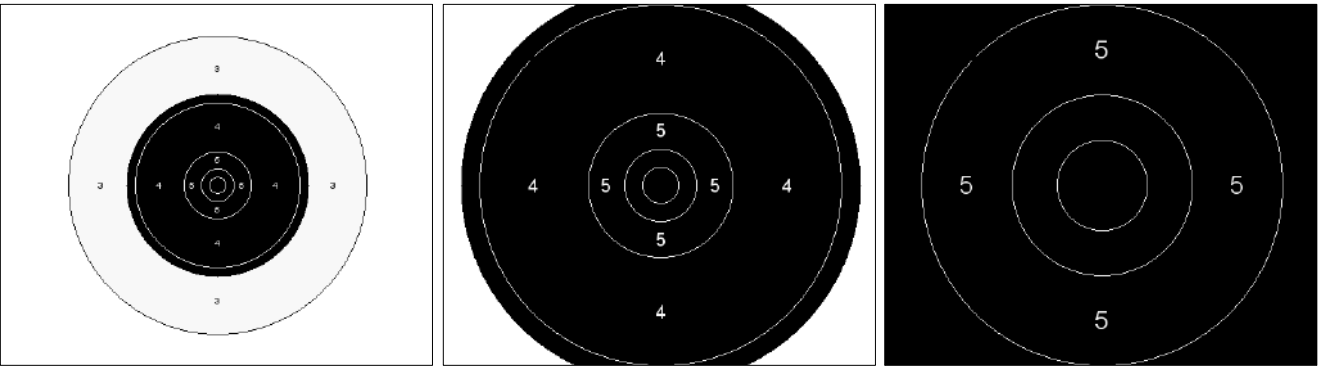

Technical data

Part No	735-0097-97-0137
Size	18 kb
Gauge (default)	7,62 mm
Aiming mark diameter	610 mm
Manufacture	
Manufacture Part No	

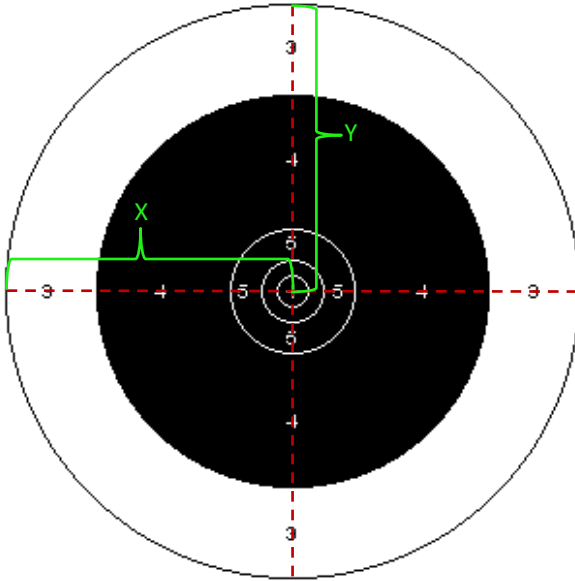

Diameter (mm)	Value
73	X
146	V
292	5
920	4
1335	3

X	667,5 mm
Y	667,5 mm

Zoom levels

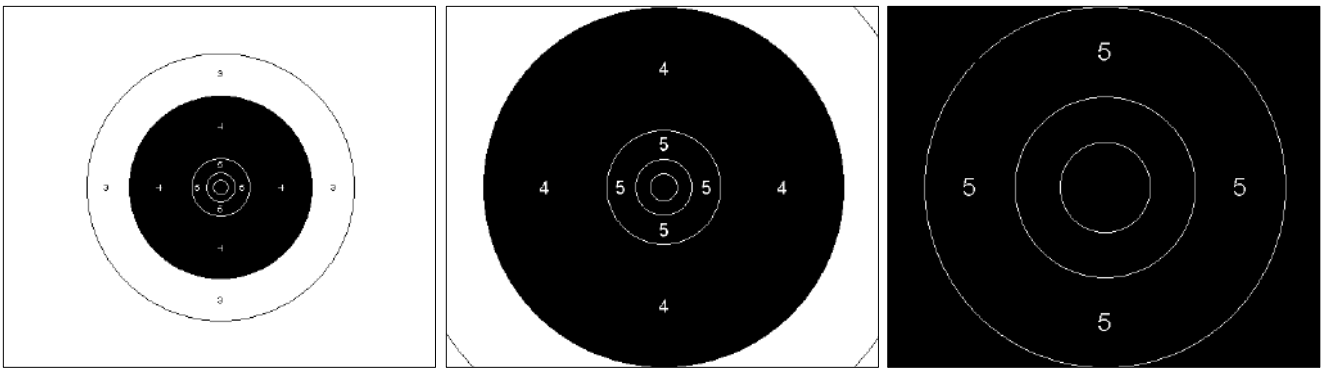

Technical data

Part No	735-0097-97-0138
Size	18 kb
Gauge (default)	7,62 mm
Aiming mark diameter	920 mm
Manufacture	
Manufacture Part No	

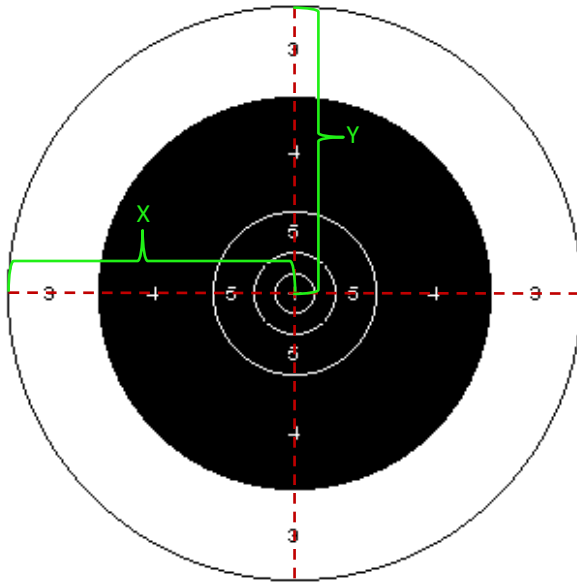

Diameter (mm)	Value
95	X
190	V
380	5
920	4
1335	3

X	667,5 mm
Y	667,5 mm

Zoom levels

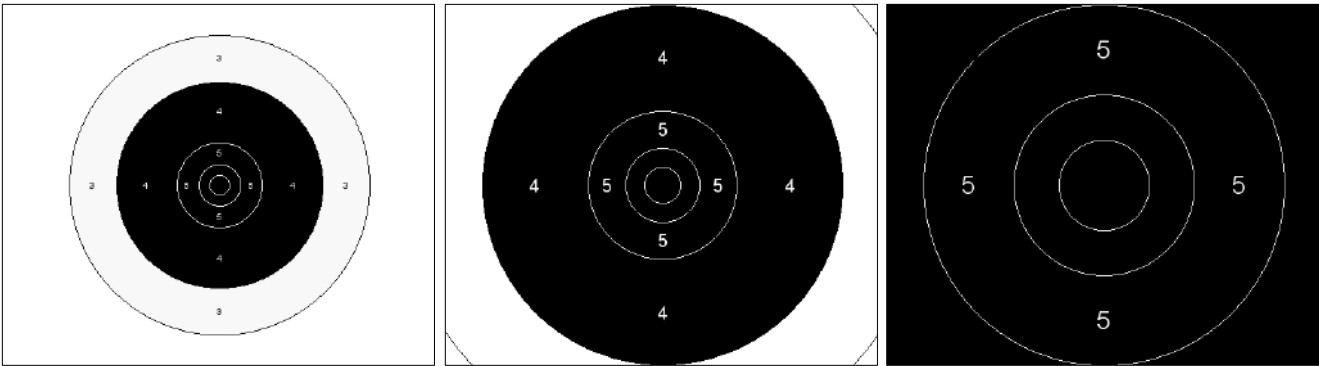

Technical data

Part No	735-0097-97-0139
Size	18 kb
Gauge (default)	7,62 mm
Aiming mark diameter	920 mm
Manufacture	
Manufacture Part No	

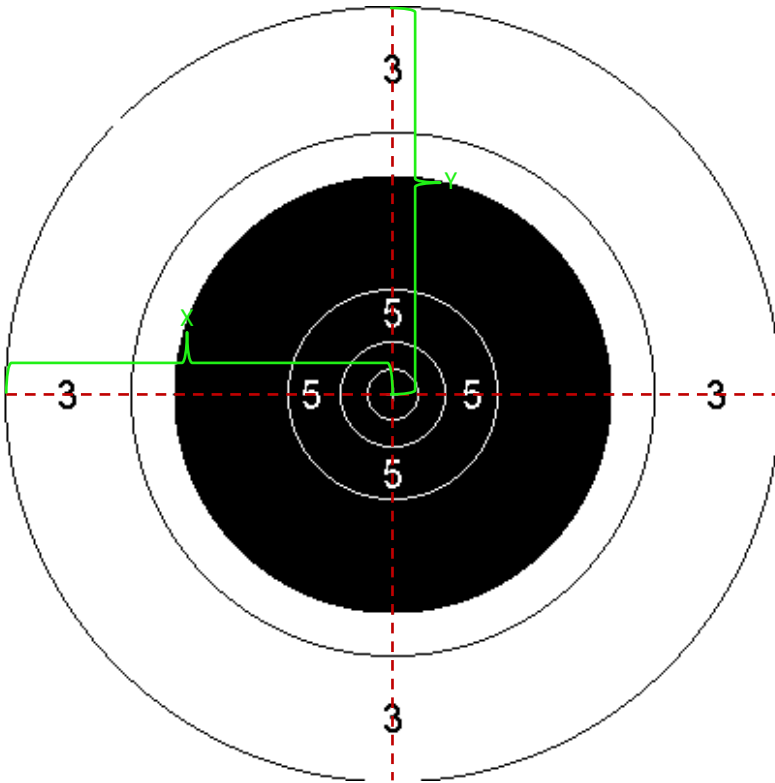

Diameter (mm)	Value
123,5	X
247	V
494	5
1220	4
1800	3

X	900 mm
Y	900 mm

Zoom levels

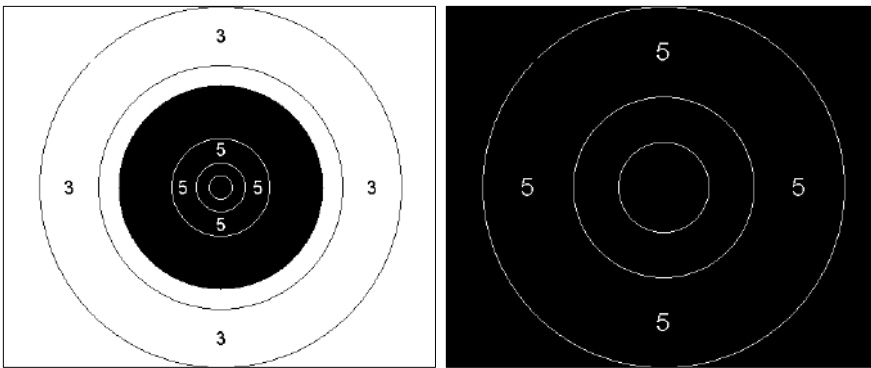

Technical data

Part No	735-0097-97-0140
Size	18 kb
Gauge (default)	7,62 mm
Aiming mark diameter	1020 mm
Manufacture	
Manufacture Part No	

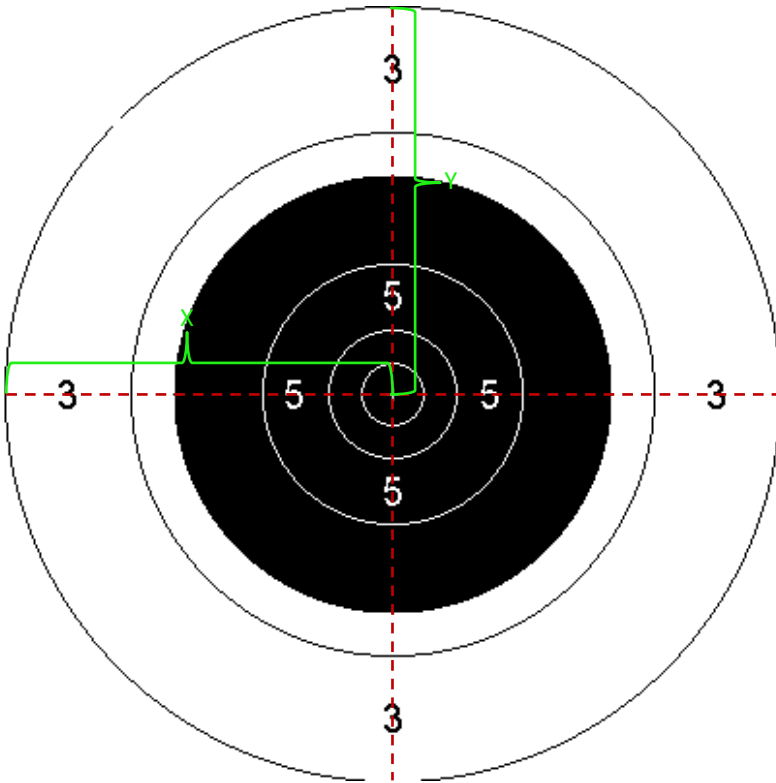

Diameter (mm)	Value
152,5	X
305	V
610	5
1220	4
1800	3

X	900 mm
Y	900 mm

Zoom levels

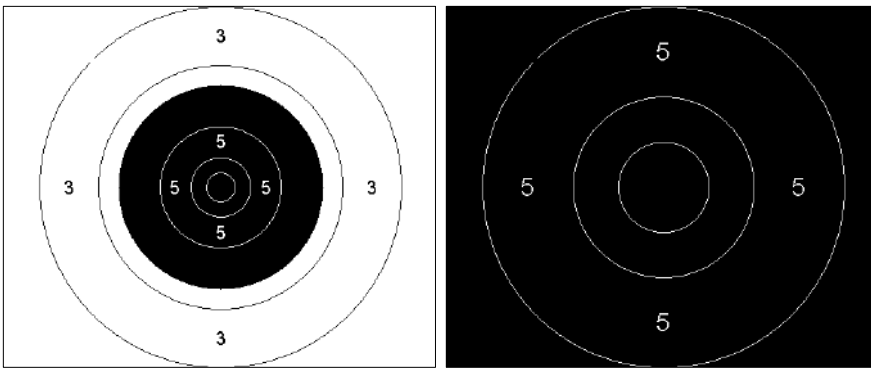

Technical data

Part No	735-0097-97-0141
Size	18 kb
Gauge (default)	7,62 mm
Aiming mark diameter	1020 mm
Manufacture	
Manufacture Part No	

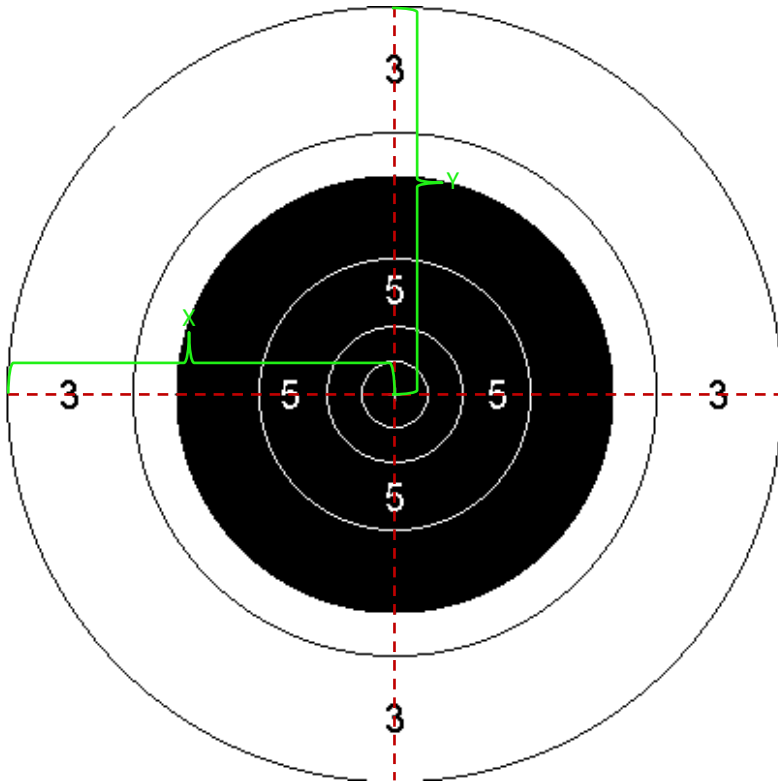

Diameter (mm)	Value
160	X
320	V
635	5
1220	4
1800	3

X	900 mm
Y	900 mm

Zoom levels

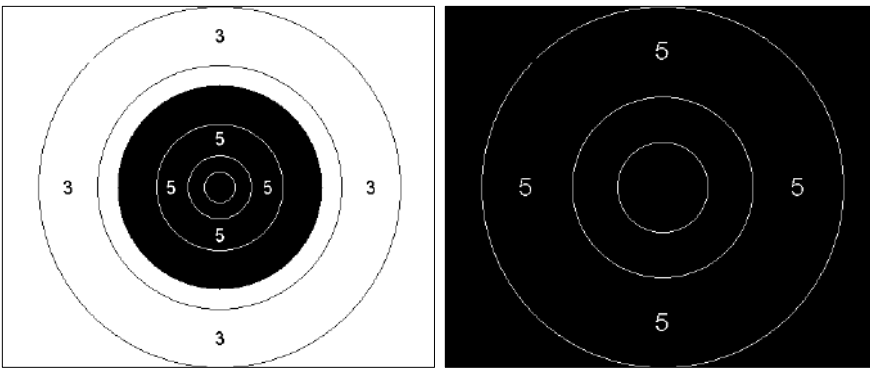

Technical data

Part No	735-0097-97-0142
Size	16 kb
Gauge (default)	7,62 mm
Aiming mark diameter	1020 mm
Manufacture	
Manufacture Part No	

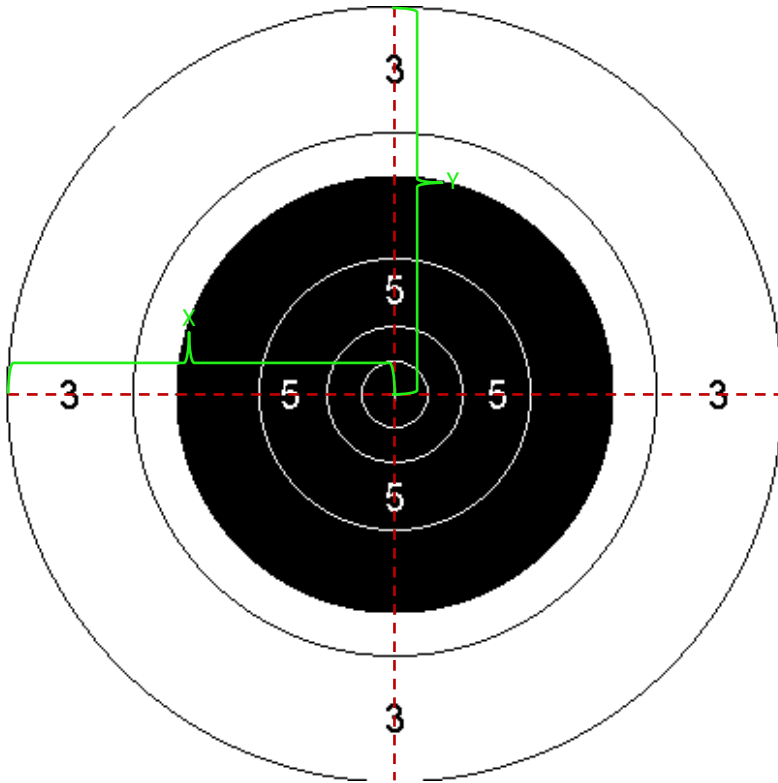

Diameter (mm)	Value
160	X
320	V
635	5
1220	4
1800	3

X	900 mm
Y	900 mm

Zoom levels

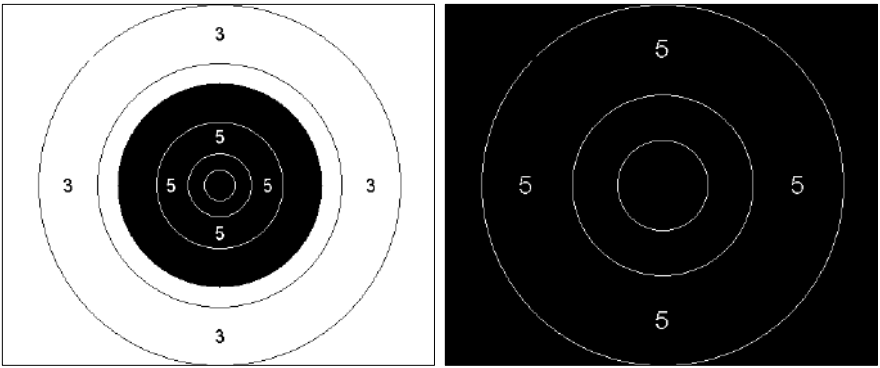

Technical data

Part No	735-0097-97-0143
Size	16 kb
Gauge (default)	7,62 mm
Aiming mark diameter	1020 mm
Manufacture	
Manufacture Part No	

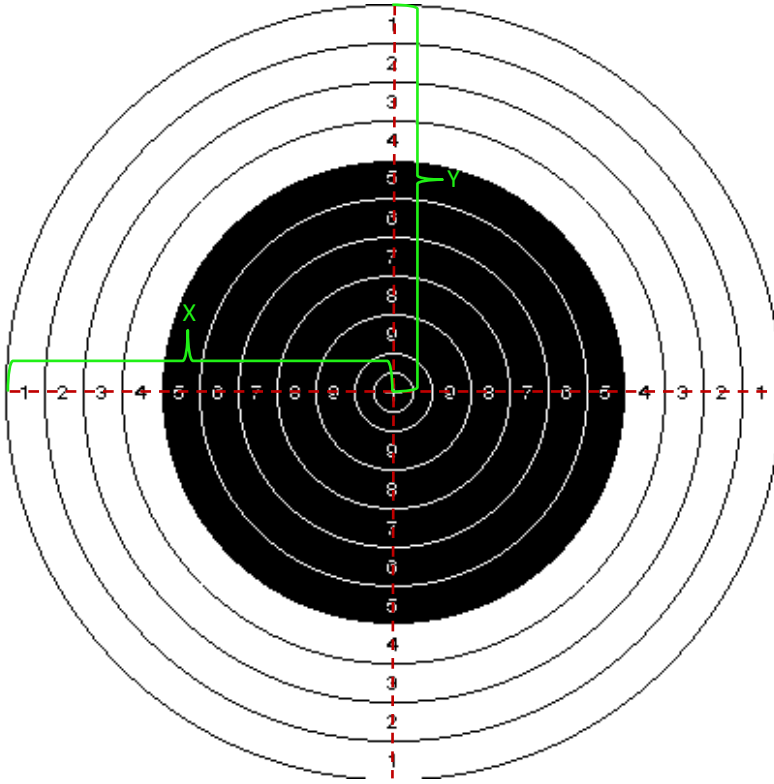

Diameter (mm)	Value
17	*
34	X
68	9
102	8
136	7
170	6
204	5
238	4
272	3
306	2
340	1

X	170 mm
Y	170 mm

Zoom levels

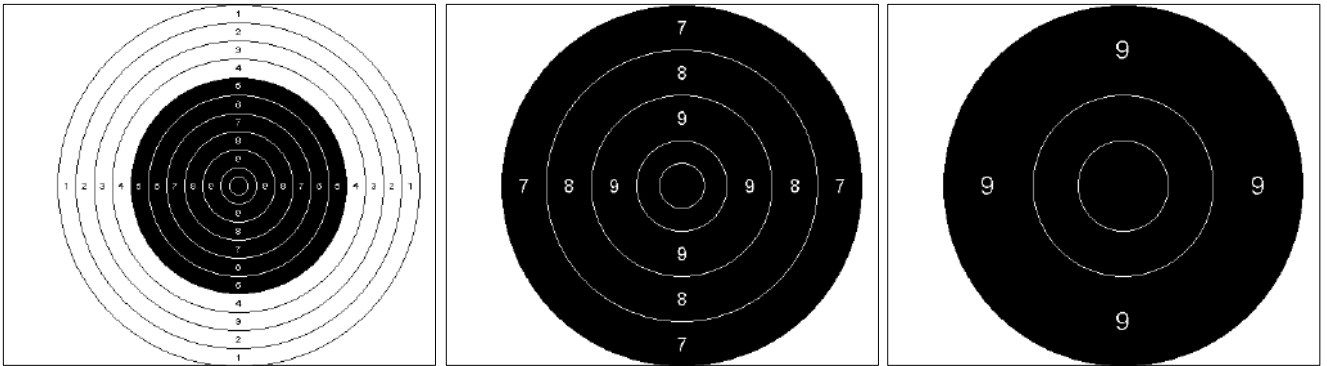

Technical data

Part No	735-0097-97-0146
Size	N/A
Gauge (default)	8 mm
Aiming mark diameter	204 mm
Manufacture	
Manufacture Part No	

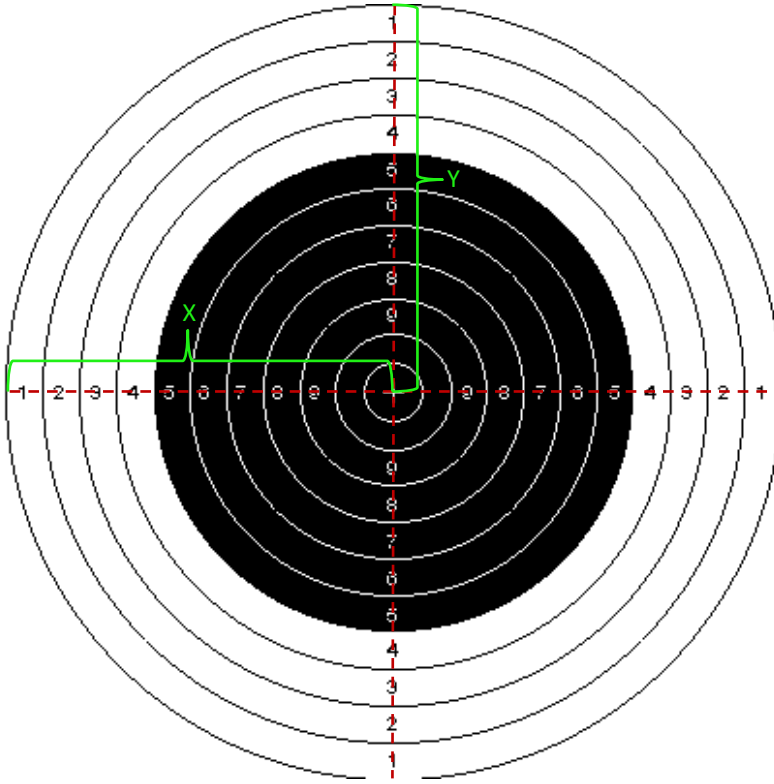

Diameter (mm)	Value
13,5	*
27	X
44	9
61	8
78	7
95	6
112	5
129	4
146	3
163	2
180	1

X	90 mm
Y	90 mm

Zoom levels

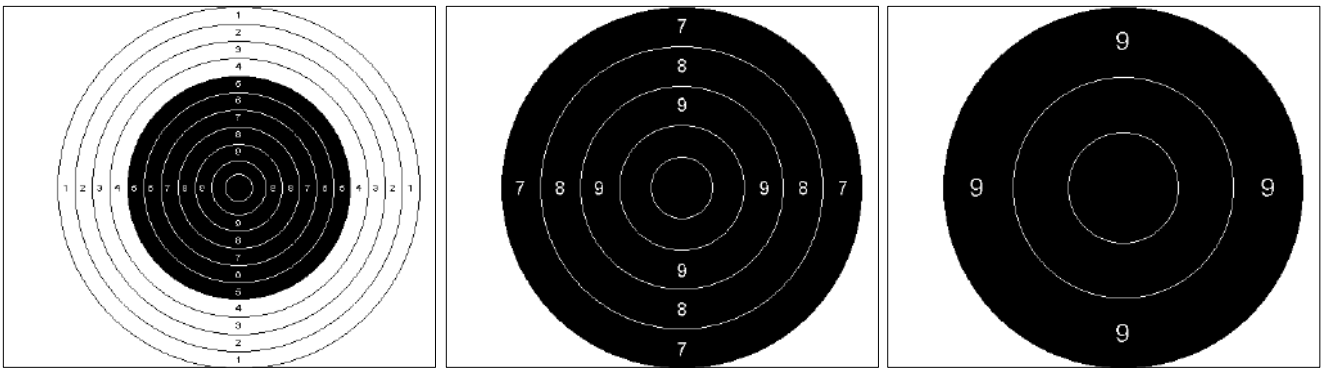

Technical data

Part No	735-0097-97-0147
Size	N/A
Gauge (default)	8 mm
Aiming mark diameter	112 mm
Manufacture	
Manufacture Part No	

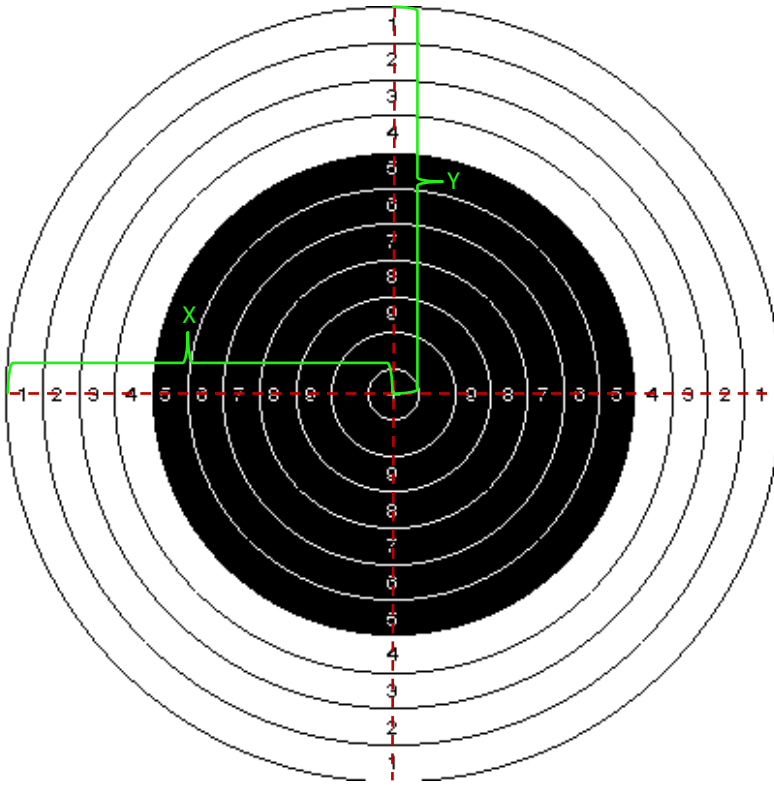

Diameter (mm)	Value
25	*
50	X
100	9
150	8
200	7
250	6
300	5
350	4
400	3
450	2
500	1

X	250 mm
Y	250 mm

Zoom levels

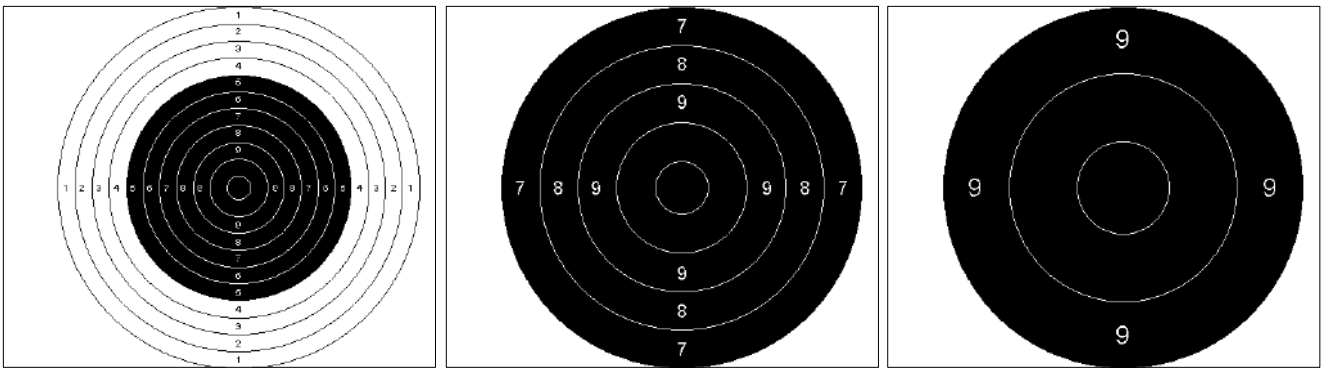

Technical data

Part No	735-0097-97-0148
Size	N/A
Gauge (default)	8 mm
Aiming mark diameter	200 mm
Manufacture	
Manufacture Part No	

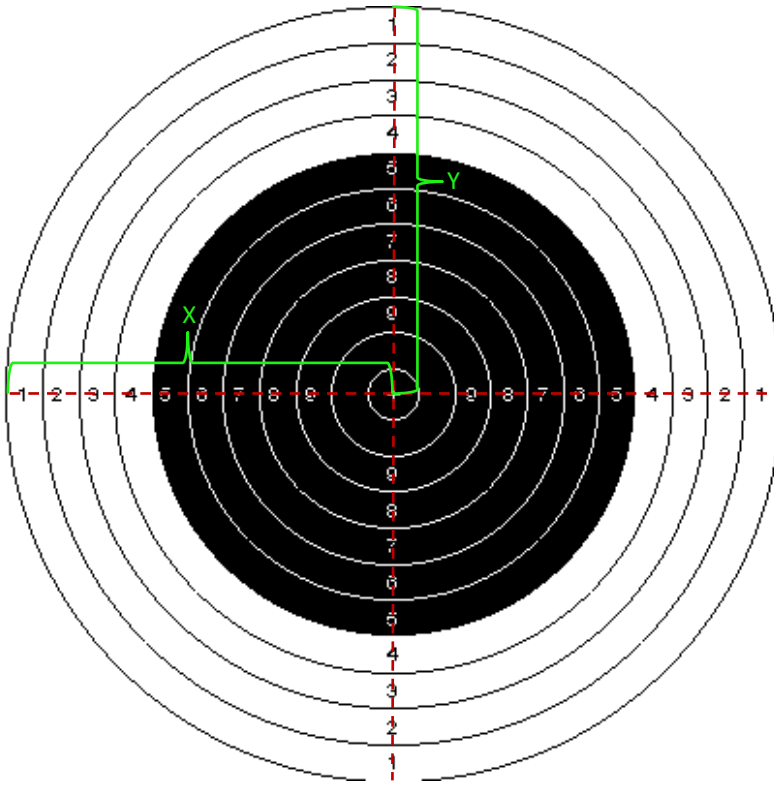

Diameter (mm)	Value
35	*
86	X
136	9
186	8
236	7
286	6
336	5
386	4
436	3
486	2
536	1

X	268 mm
Y	268 mm

Zoom levels

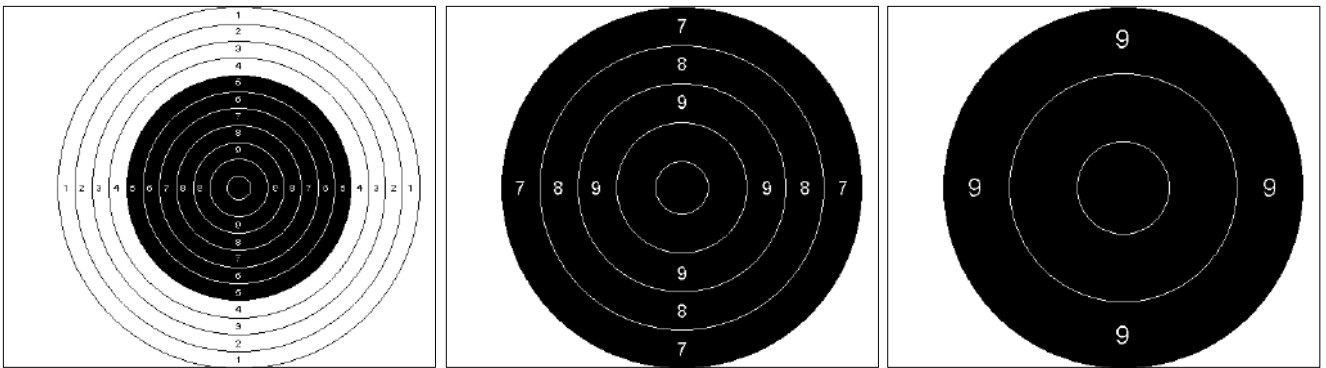

Technical data

Part No	735-0097-97-0149
Size	N/A
Gauge (default)	8 mm
Aiming mark diameter	336 mm
Manufacture	
Manufacture Part No	

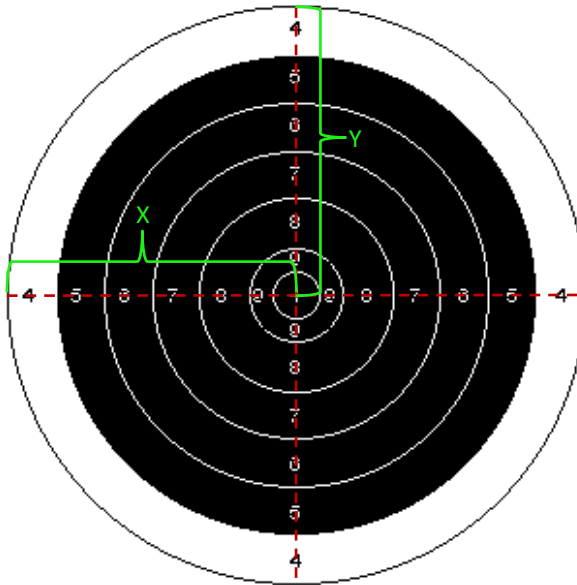

Diameter (mm)	Value
44	X
87	9
175	8
262	7
349	6
436	5
524	4

X	262 mm
Y	262 mm

Zoom levels

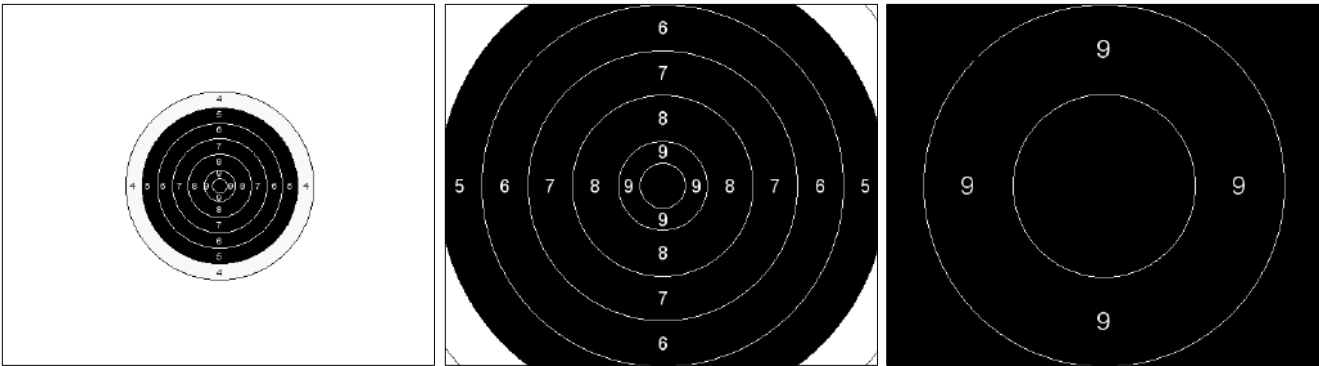

Technical data

Part No	735-0097-97-0150
Size	16 kb
Gauge (default)	8 mm
Aiming mark diameter	436 mm
Manufacture	
Manufacture Part No	

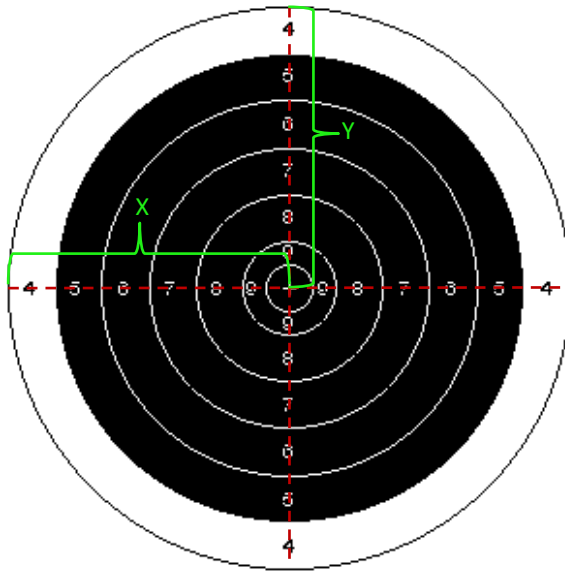

Diameter (mm)	Value
73	X
145	9
291	8
436	7
582	6
727	5
873	4

X	436,5 mm
Y	436,5 mm

Zoom levels



Technical data

Part No	735-0097-97-0151
Size	16 kb
Gauge (default)	8 mm
Aiming mark diameter	727 mm
Manufacture	
Manufacture Part No	

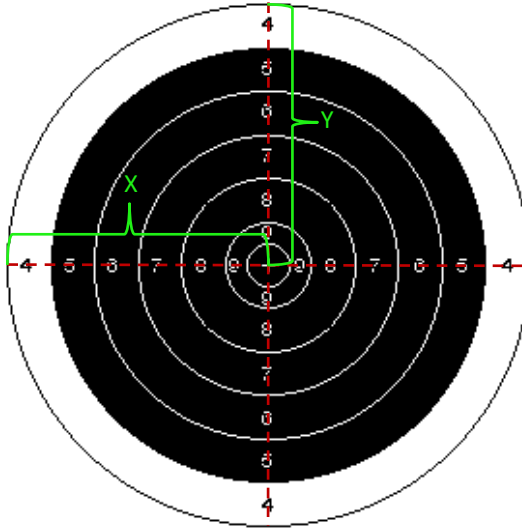

Diameter (mm)	Value
102	X
204	9
407	8
611	7
814	6
1018	5
1222	4

X	611 mm
Y	611 mm

Zoom levels

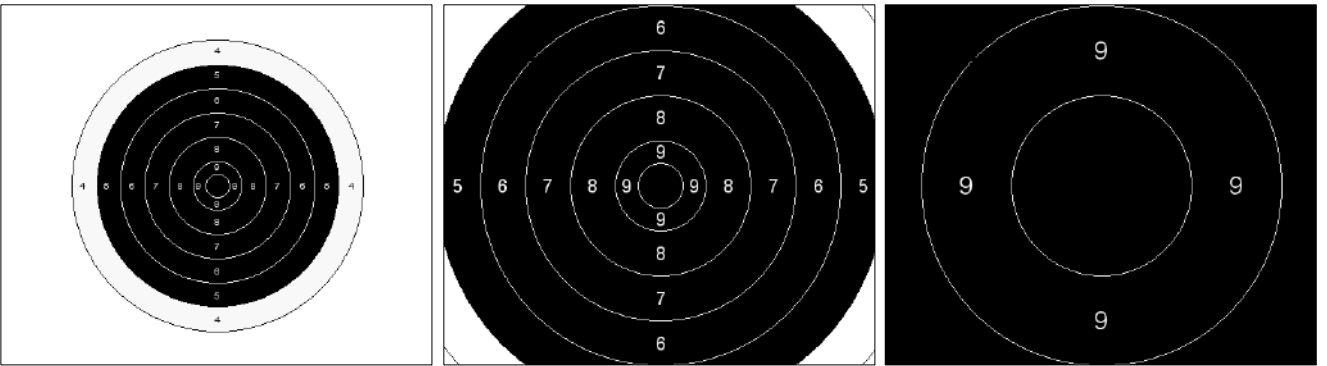

Technical data

Part No	735-0097-97-0152
Size	16 kb
Gauge (default)	8 mm
Aiming mark diameter	1018 mm
Manufacture	
Manufacture Part No	

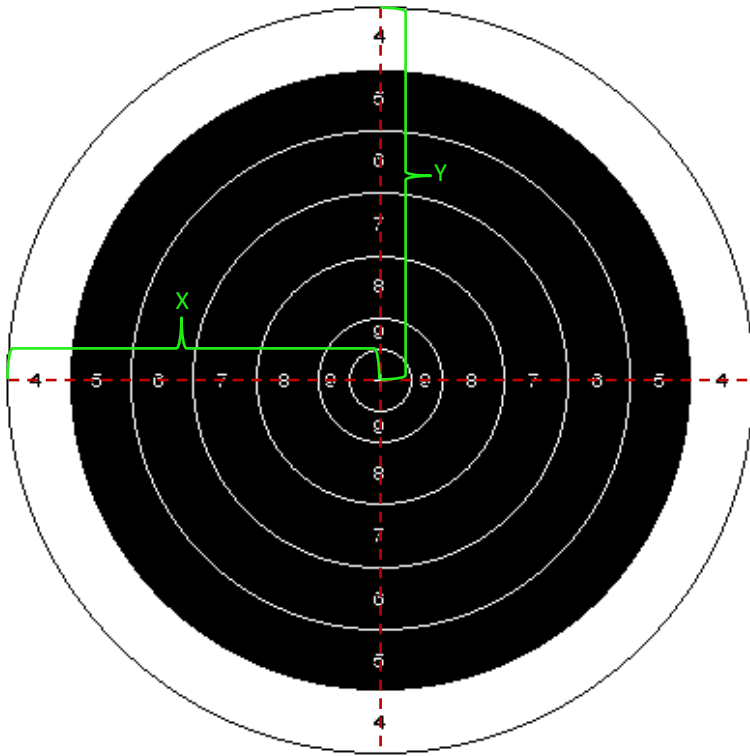

Diameter (mm)	Value
145	X
291	9
582	8
873	7
1164	6
1454	5
1745	4

X	727 mm
Y	727 mm

Zoom levels

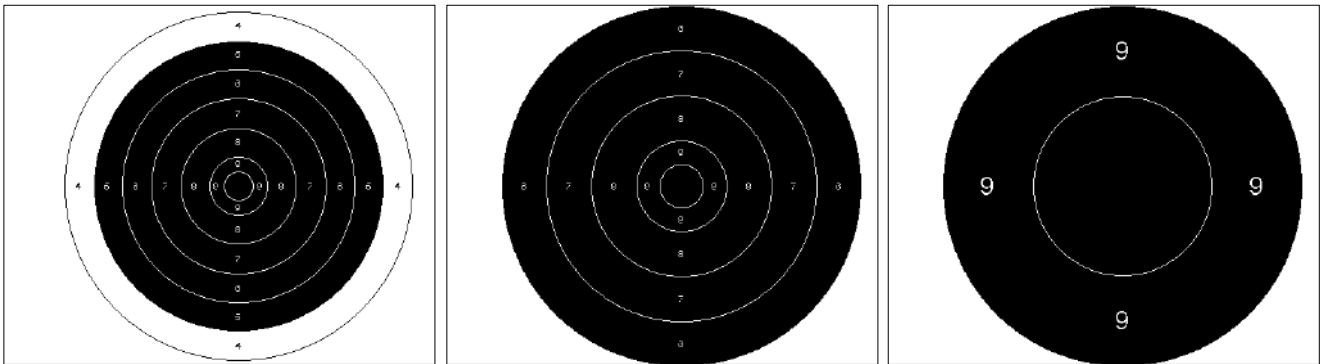

Technical data

Part No	735-0097-97-0153
Size	16 kb
Gauge (default)	8 mm
Aiming mark diameter	1454 mm
Manufacture	
Manufacture Part No	

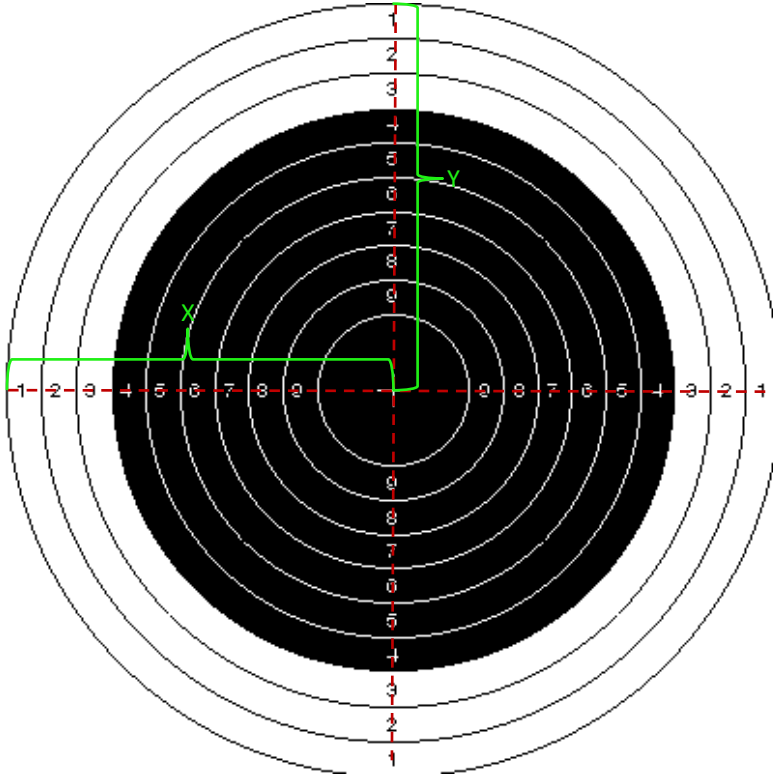

Diameter (mm)	Value
11	X
16	9
21	8
26	7
31	6
36	5
41	4
46	3
51	2
56	1

X	20,5 mm
Y	20,5 mm

Zoom levels

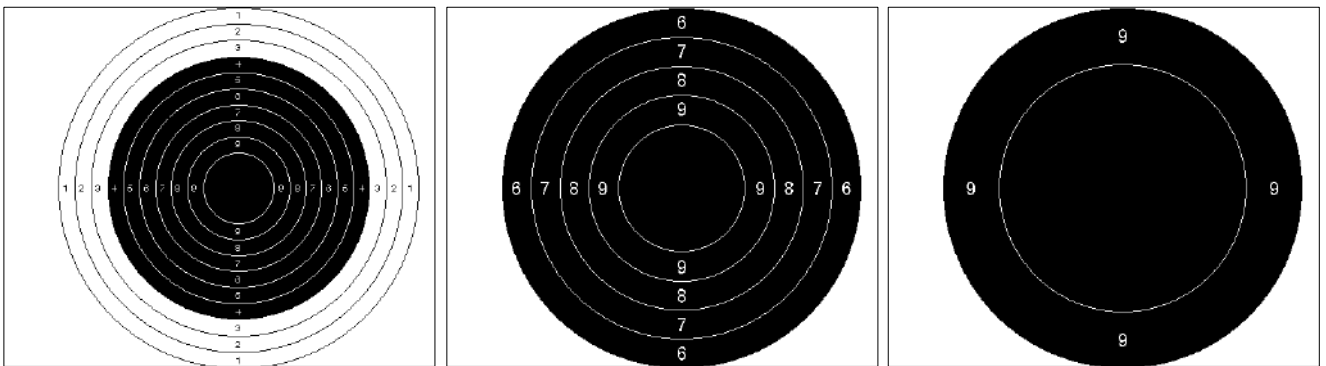

Technical data

Part No	735-0097-97-0154
Size	N/A
Gauge (default)	8 mm
Aiming mark diameter	41 mm
Manufacture	
Manufacture Part No	

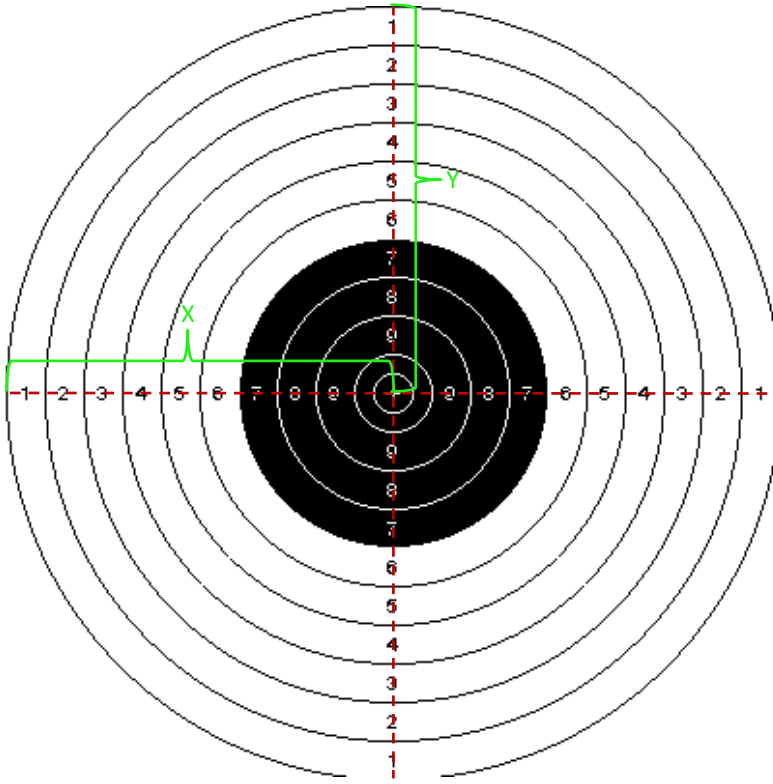

Diameter (mm)	Value
25	*
50	X
100	9
150	8
200	7
250	6
300	5
350	4
400	3
450	2
500	1

X	250 mm
Y	250 mm

Zoom levels

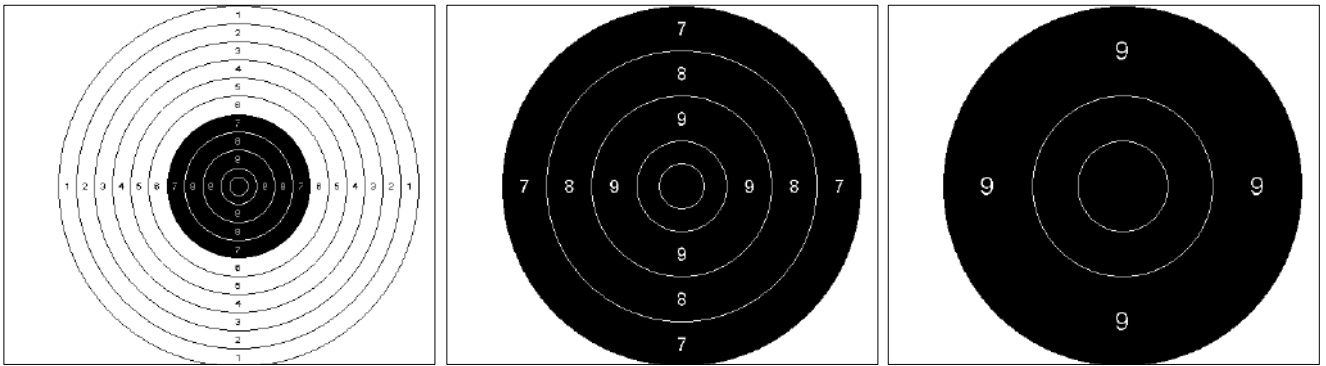

Technical data

Part No	735-0097-97-0169
Size	N/A
Gauge (default)	8 mm
Aiming mark diameter	200 mm
Manufacture	
Manufacture Part No	

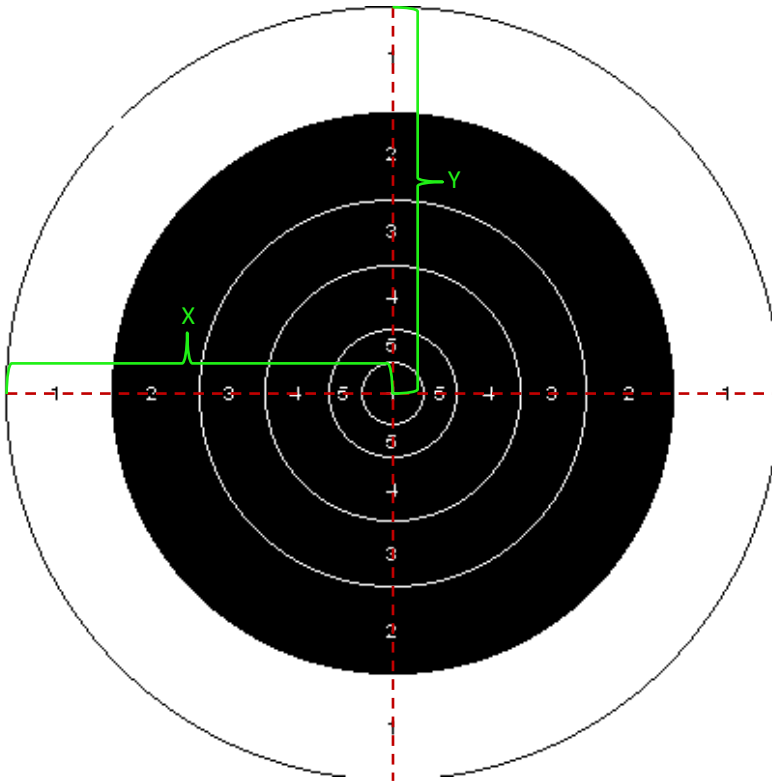

Diameter (mm)	Value
127	V
254	5
508	4
762	3
1118	2
1524	1

X	762 mm
Y	762 mm

Zoom levels

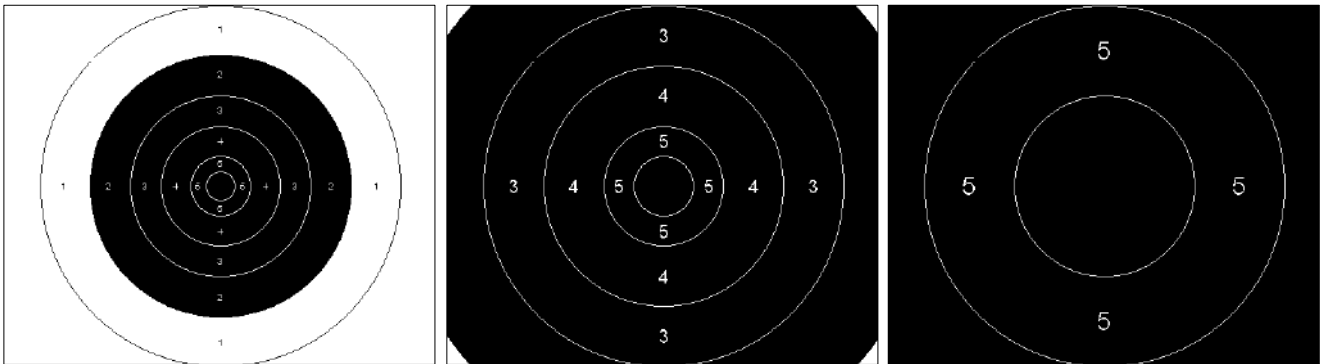

Technical data

Part No	735-0097-97-0171
Size	2 kb
Gauge (default)	7,62 mm
Aiming mark diameter	1118 mm
Manufacture	
Manufacture Part No	

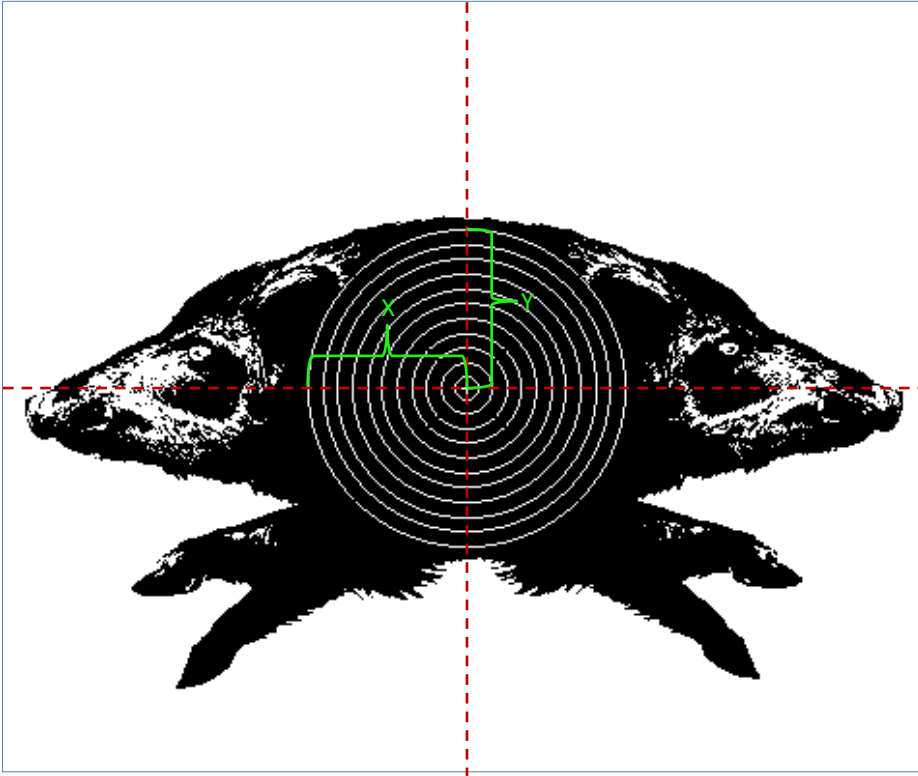

Diameter (mm)	Value
30	*
60	X
96	9
128	8
162	7
196	6
230	5
264	4
298	3
332	2
366	1

X	183 mm
Y	183 mm

Zoom levels

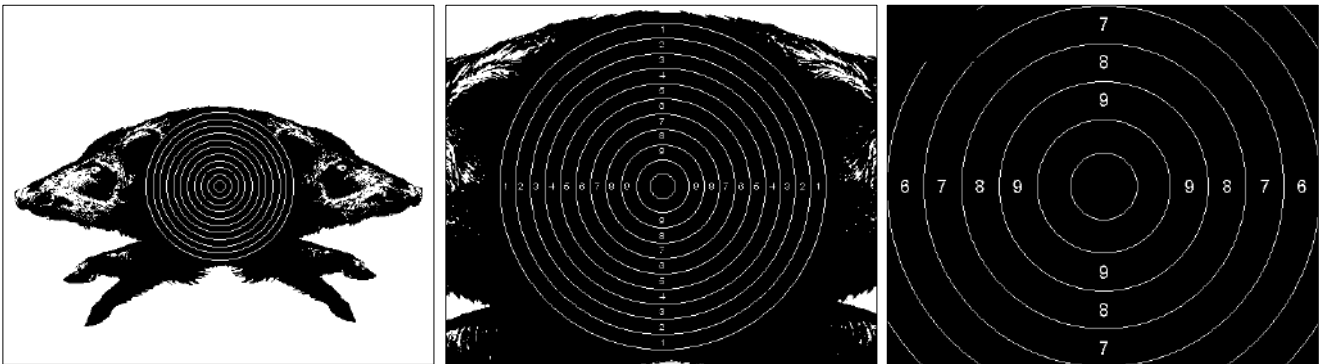

Technical data

Part No	735-0097-97-0181
Size	35 kb
Gauge (default)	5,6 mm
Aiming mark diameter	366 mm
Manufacture	
Manufacture Part No	

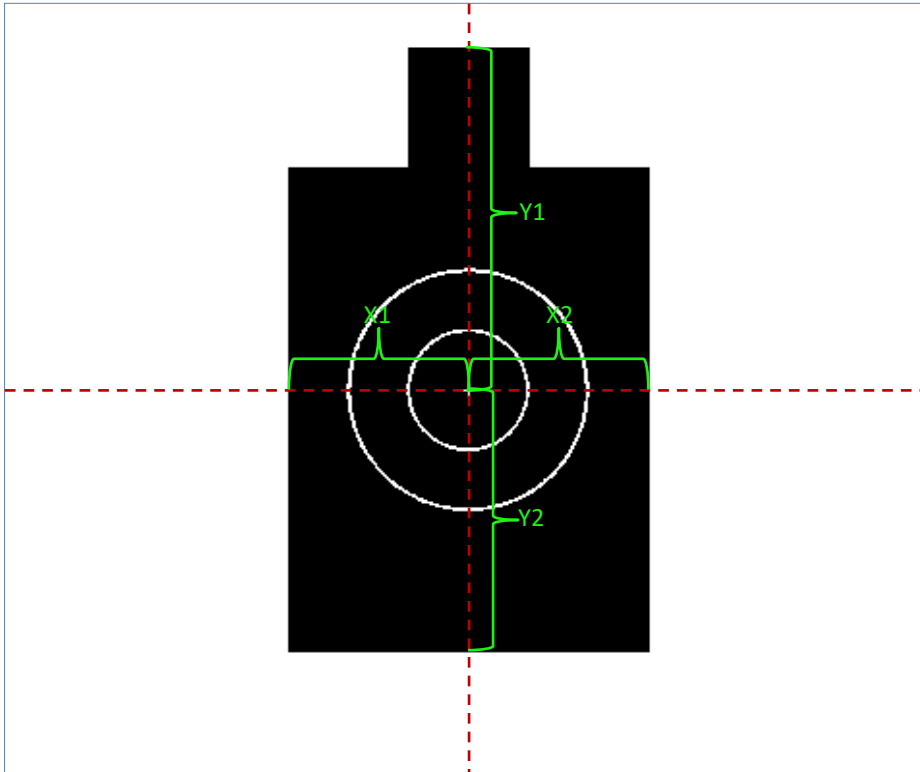

Diameter (mm)	Value
304	*
150	X

X1	225 mm	X2	225 mm
Y1	423 mm	Y2	327 mm

Zoom levels

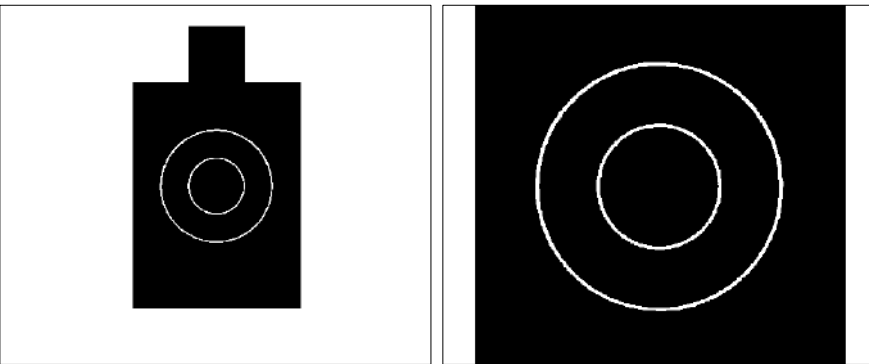

Technical data

Part No	735-0097-97-0187
Size	60 kb
Gauge (default)	7,62 mm
Aiming mark diameter	
Manufacture	
Manufacture Part No	

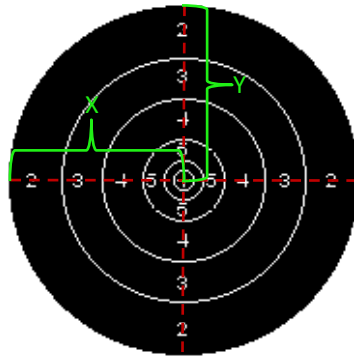

Diameter (mm)	Value
32	X
64	V
130	5
260	4
390	3
560	2
ROT	1

X	280 mm
Y	280 mm

Zoom levels

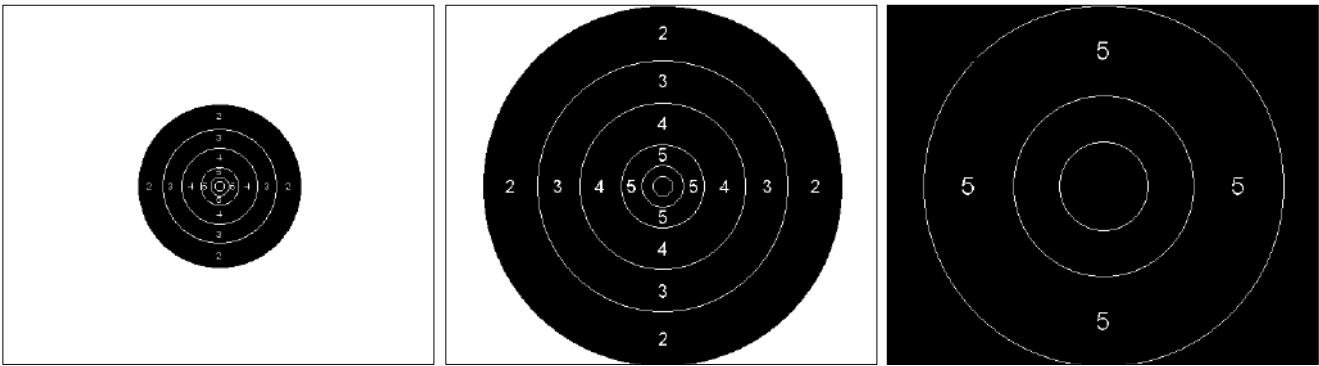

Technical data

Part No	735-0097-97-0188
Size	18 kb
Gauge (default)	7,62 mm
Aiming mark diameter	560 mm
Manufacture	
Manufacture Part No	

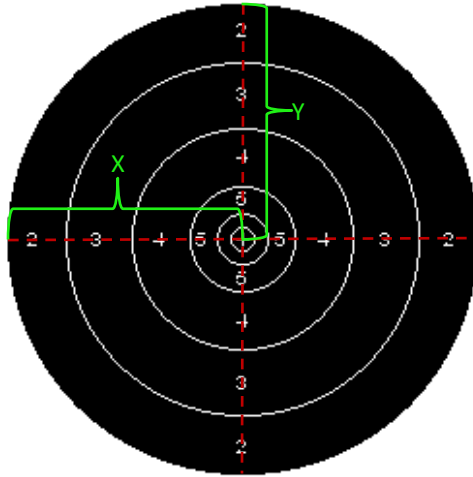

Diameter (mm)	Value
42,5	X
85	V
170	5
350	4
560	3
750	2
ROT	1

X	375 mm
Y	375 mm

Zoom levels

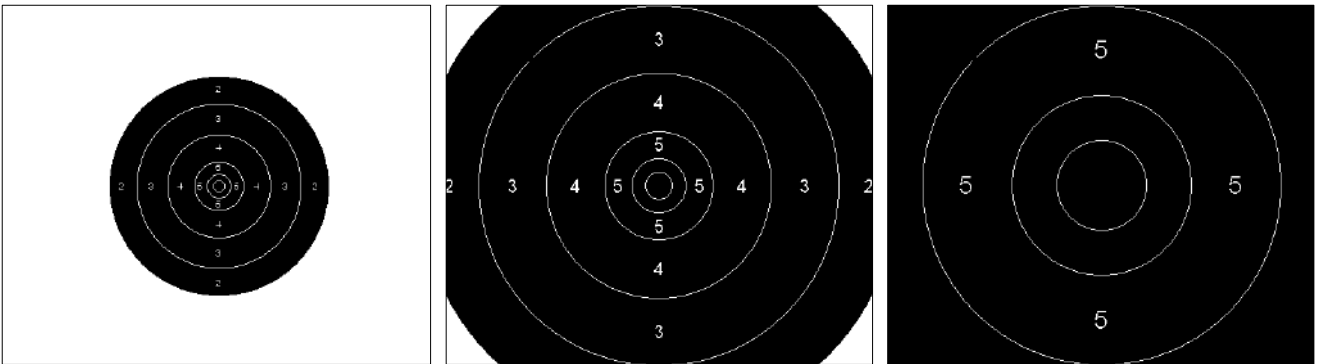

Technical data

Part No	735-0097-97-0189
Size	18 kb
Gauge (default)	7,62 mm
Aiming mark diameter	750 mm
Manufacture	
Manufacture Part No	

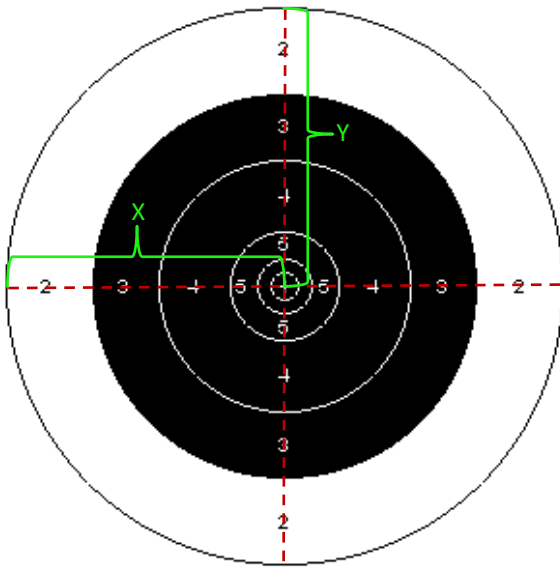

Diameter (mm)	Value
65	X
130	V
260	5
600	4
915	3
1320	2
ROT	1

X	660 mm
Y	660 mm

Zoom levels

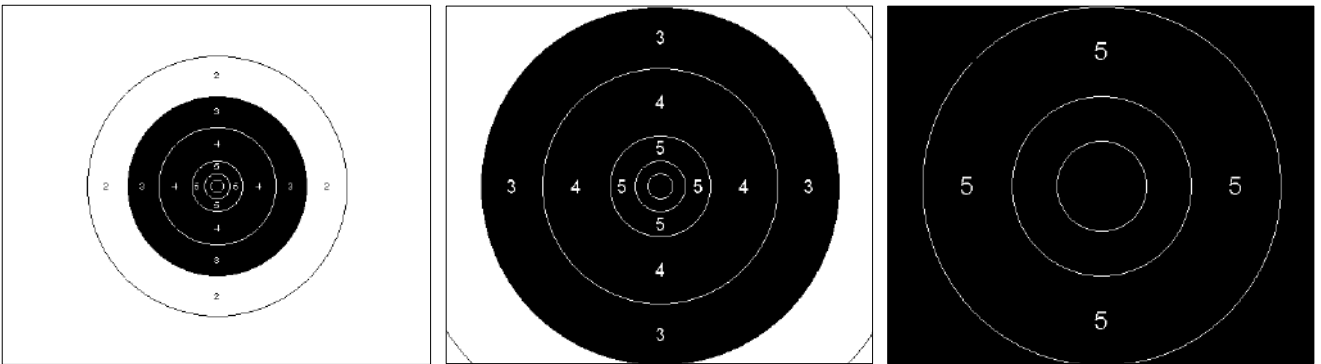

Technical data

Part No	735-0097-97-0190
Size	18 kb
Gauge (default)	7,62 mm
Aiming mark diameter	915 mm
Manufacture	
Manufacture Part No	

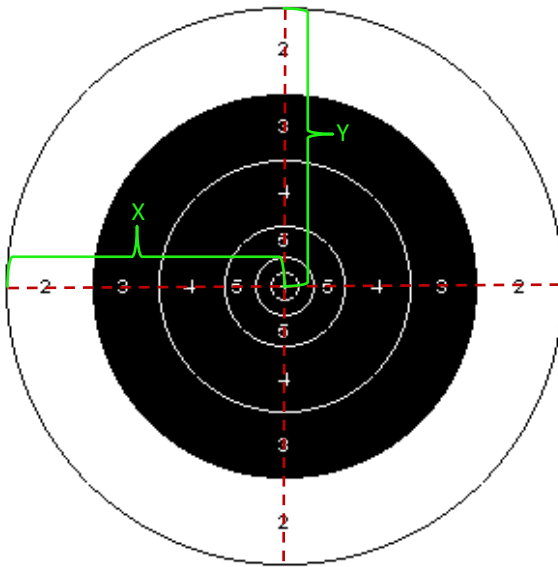

Diameter (mm)	Value
72	X
145	V
290	5
600	4
915	3
1320	2
ROT	1

X	660 mm
Y	660 mm

Zoom levels

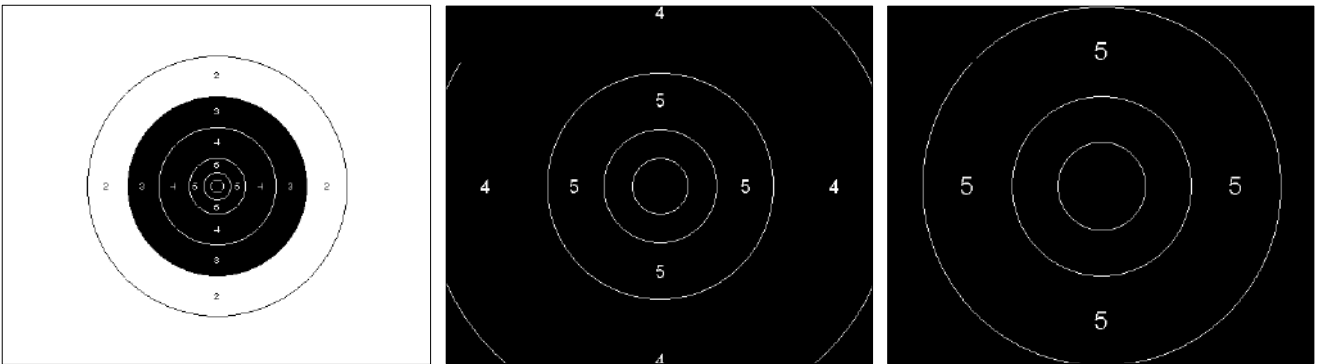

Technical data

Part No	735-0097-97-0191
Size	18 kb
Gauge (default)	7,62 mm
Aiming mark diameter	915 mm
Manufacture	
Manufacture Part No	

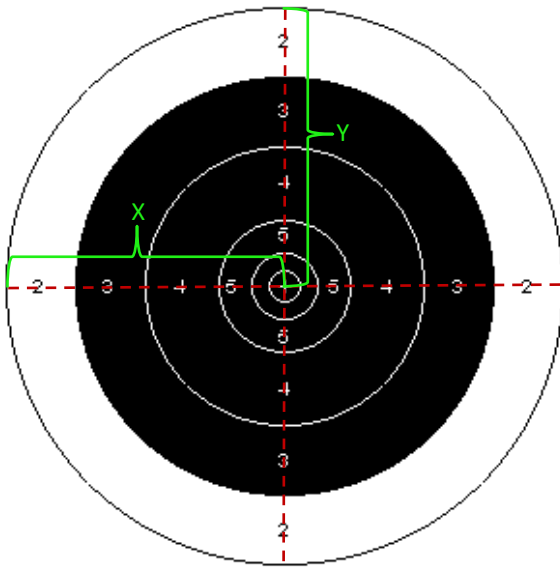

Diameter (mm)	Value
80	X
160	V
220	5
660	4
1000	3
1320	2
ROT	1

X	660 mm
Y	660 mm

Zoom levels

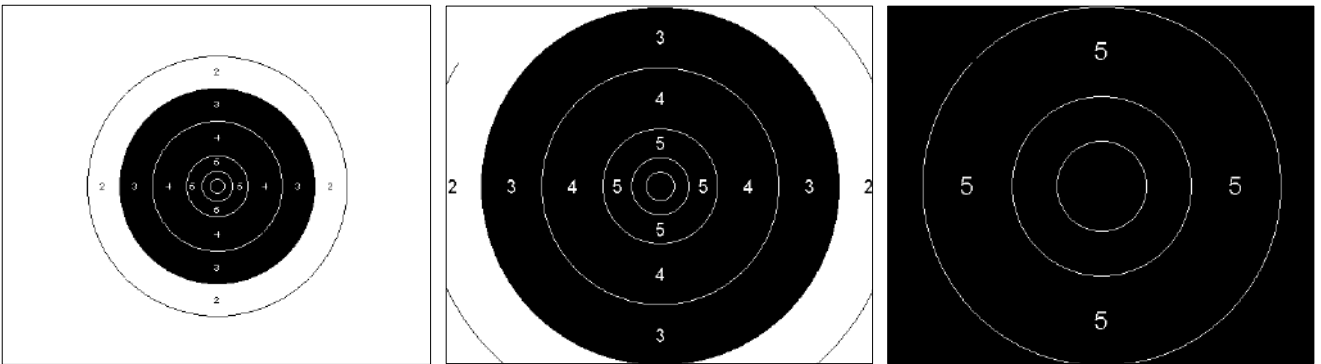

Technical data

Part No	735-0097-97-0192
Size	18 kb
Gauge (default)	7,62 mm
Aiming mark diameter	1000 mm
Manufacture	
Manufacture Part No	

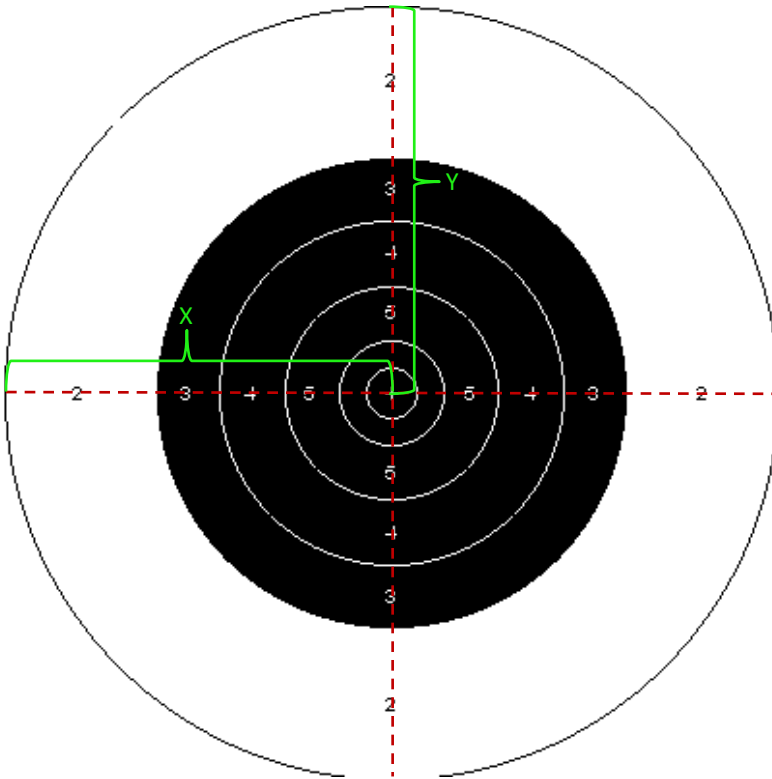

Diameter (mm)	Value
127	X
255	V
510	5
815	4
1120	3
1830	2
ROT	1

X	915 mm
Y	915 mm

Zoom levels

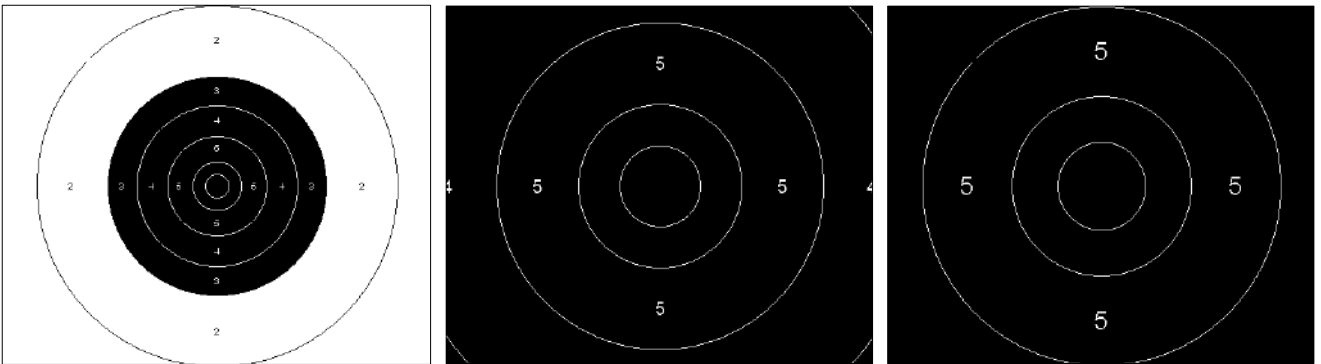

Technical data

Part No	735-0097-97-0193
Size	17 kb
Gauge (default)	7,62 mm
Aiming mark diameter	1120 mm
Manufacture	
Manufacture Part No	

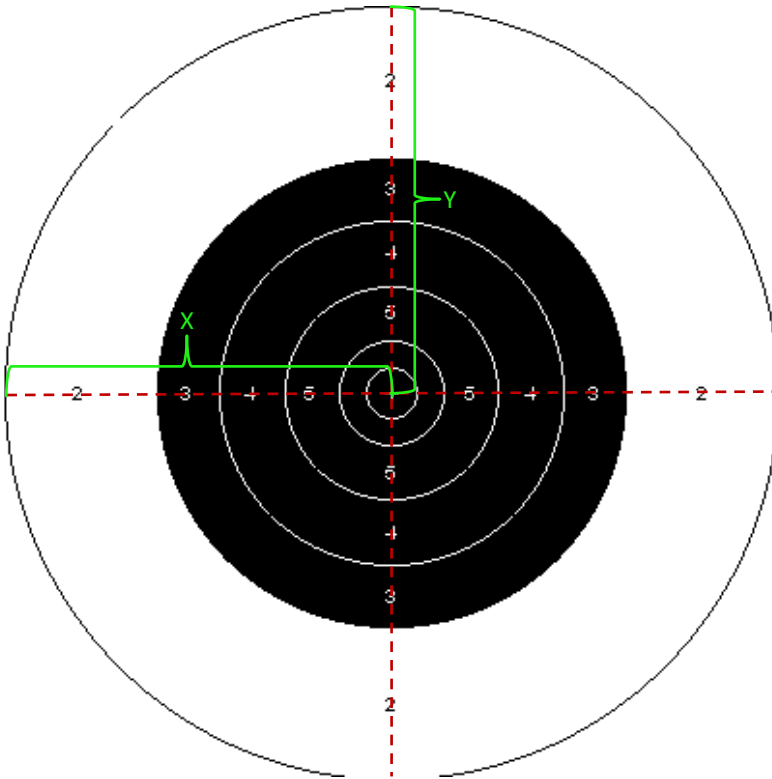

Diameter (mm)	Value
127	X
255	V
510	5
815	4
1120	3
1830	2
ROT	1

X	915 mm
Y	915 mm

Zoom levels



Technical data

Part No	735-0097-97-0194
Size	17 kb
Gauge (default)	7,62 mm
Aiming mark diameter	1120 mm
Manufacture	
Manufacture Part No	

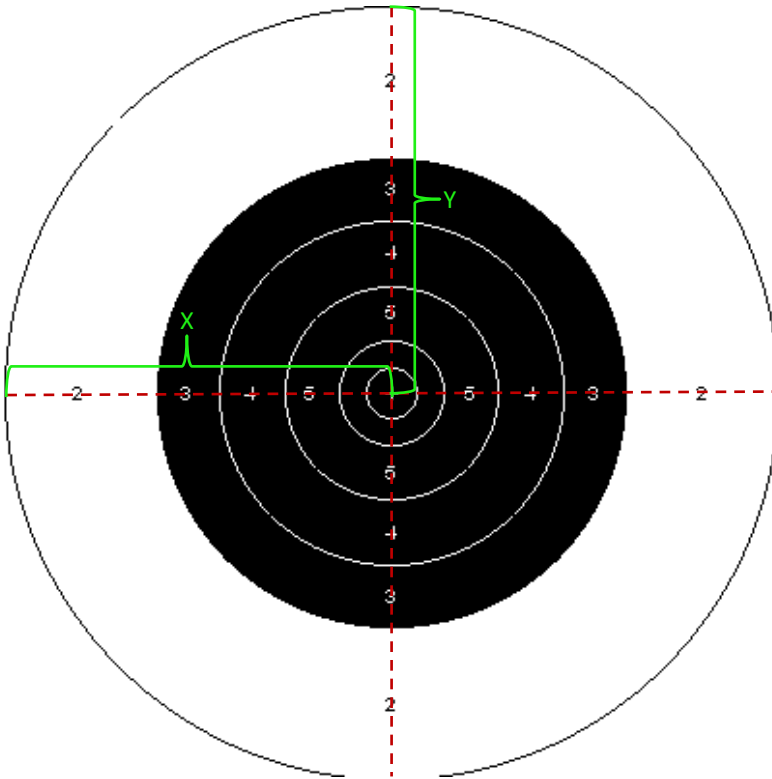

Diameter (mm)	Value
127	X
255	V
510	5
815	4
1120	3
1830	2
ROT	1

X	915 mm
Y	915 mm

Zoom levels



Technical data

Part No	735-0097-97-0195
Size	17 kb
Gauge (default)	7,62 mm
Aiming mark diameter	1120 mm
Manufacture	
Manufacture Part No	

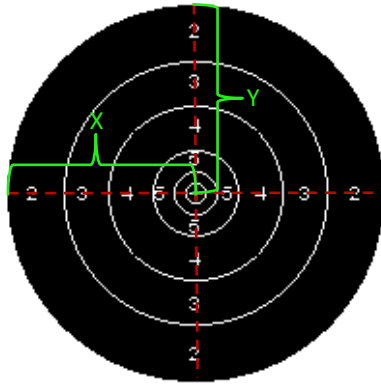

Diameter (mm)	Value
35	X
70	V
140	5
280	4
420	3
600	2
ROT	1

X	300 mm
Y	300 mm

Zoom levels

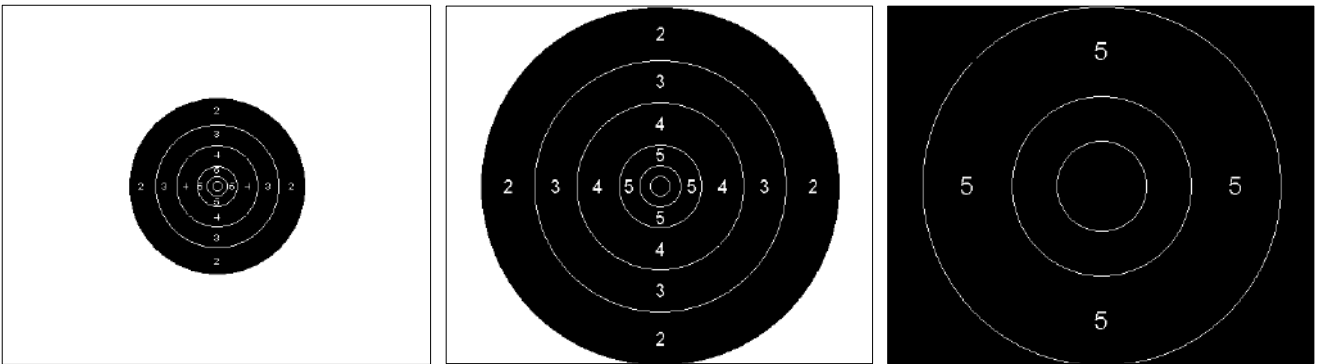

Technical data

Part No	735-0097-97-0196
Size	18 kb
Gauge (default)	7,62 mm
Aiming mark diameter	600 mm
Manufacture	
Manufacture Part No	

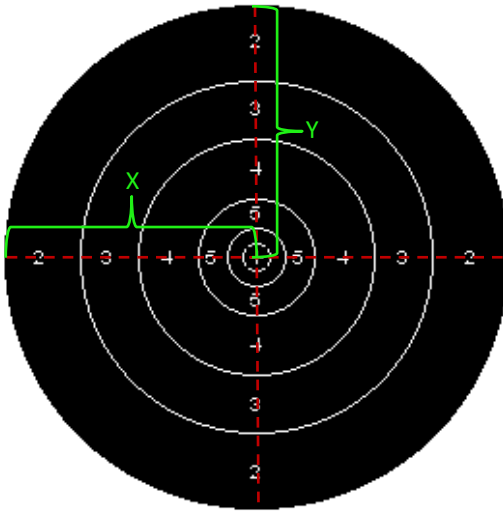

Diameter (mm)	Value
46	X
93	V
186	5
373	4
560	3
800	2
ROT1	

X	400 mm
Y	400 mm

Zoom levels



Technical data

Part No	735-0097-97-0197
Size	18 kb
Gauge (default)	7,62 mm
Aiming mark diameter	800 mm
Manufacture	
Manufacture Part No	

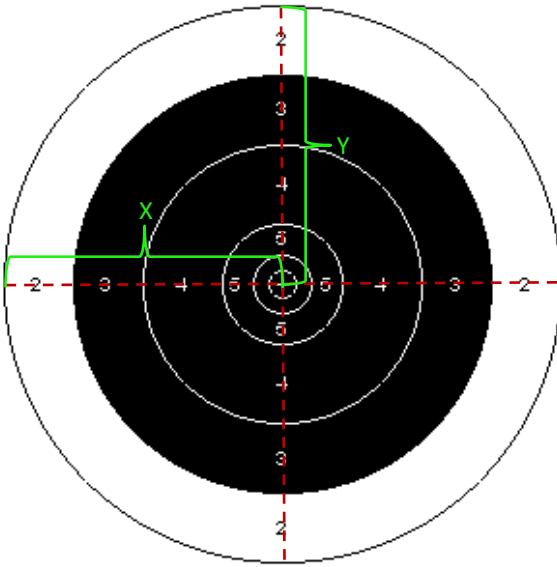

Diameter (mm)	Value
72	X
145	V
290	5
660	4
1000	3
1320	2
ROT	1

X	660 mm
Y	660 mm

Zoom levels

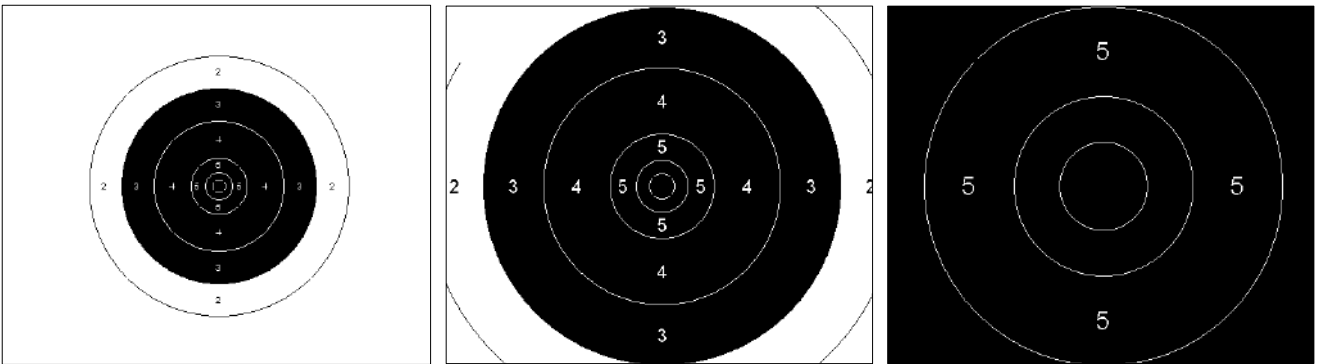

Technical data

Part No	735-0097-97-0198
Size	18 kb
Gauge (default)	7,62 mm
Aiming mark diameter	1000 mm
Manufacture	
Manufacture Part No	

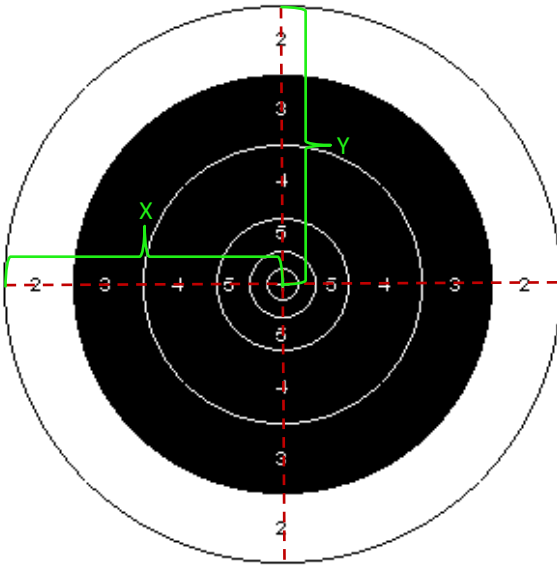

Diameter (mm)	Value
80	X
160	V
320	5
660	4
1000	3
1320	2
ROT	1

X	660 mm
Y	660 mm

Zoom levels

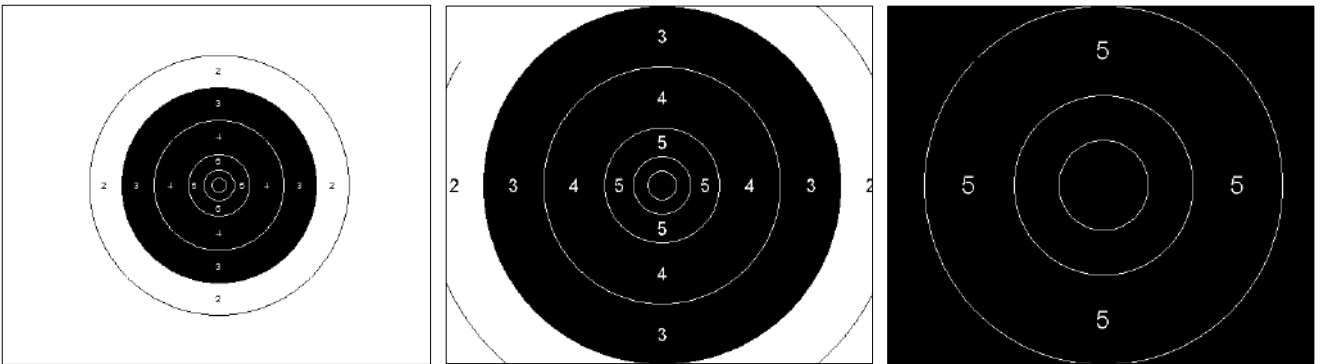

Technical data

Part No	735-0097-97-0199
Size	18 kb
Gauge (default)	7,62 mm
Aiming mark diameter	1000 mm
Manufacture	
Manufacture Part No	

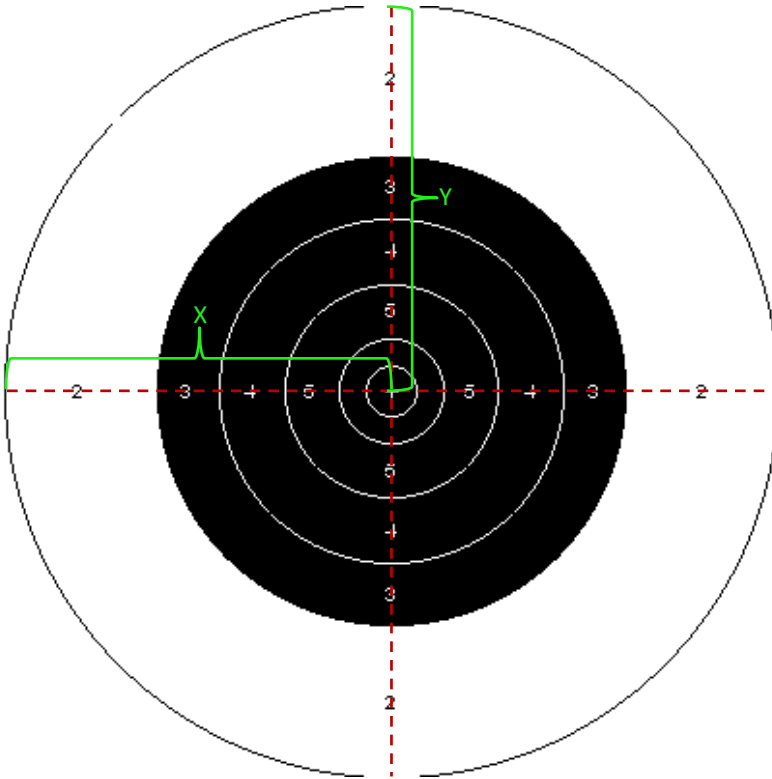

Diameter (mm)	Value
127	X
255	V
510	5
815	4
1120	3
1830	2
ROT	1

X	915 mm
Y	915 mm

Zoom levels

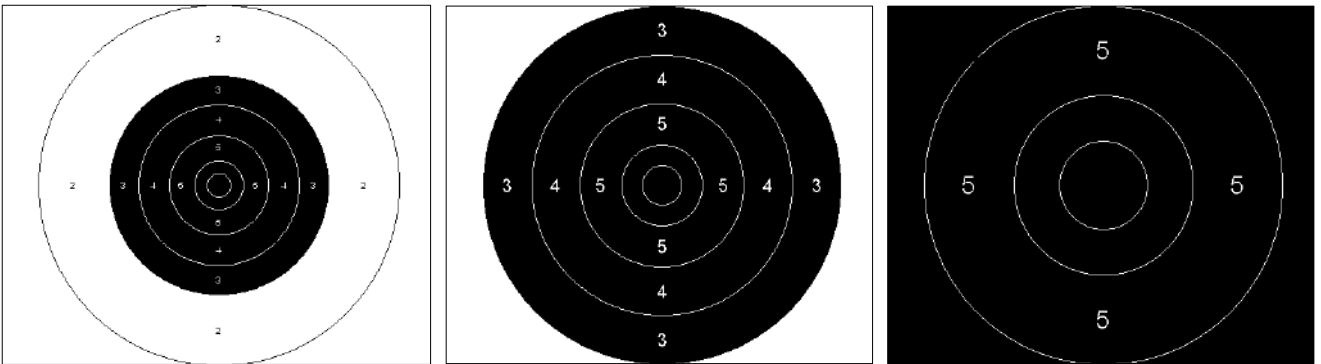

Technical data

Part No	735-0097-97-0200
Size	17 kb
Gauge (default)	7,62 mm
Aiming mark diameter	1120 mm
Manufacture	
Manufacture Part No	

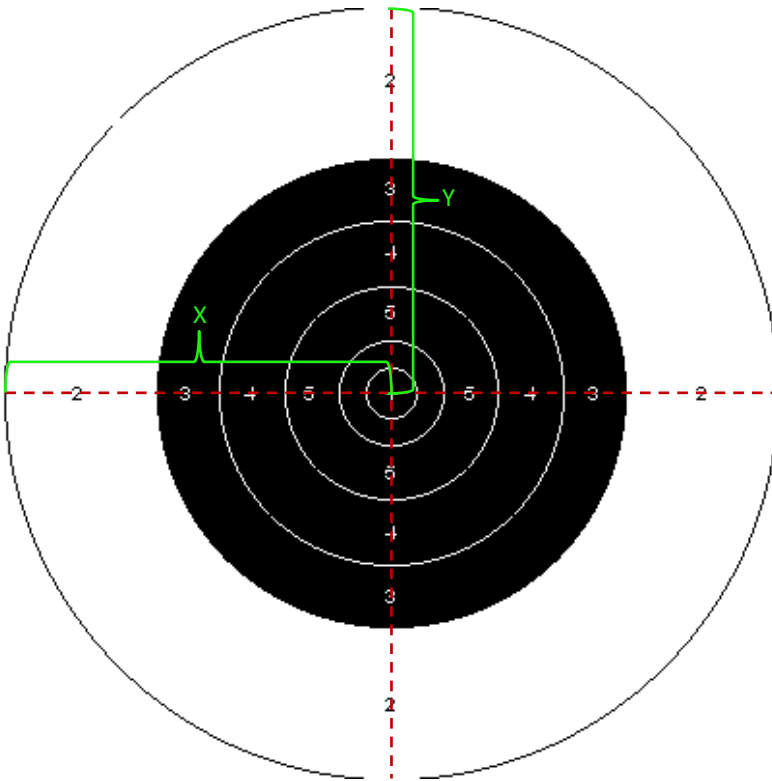

Diameter (mm)	Value
127	X
255	V
510	5
815	4
1120	3
1830	2
ROT	1

X	915 mm
Y	915 mm

Zoom levels

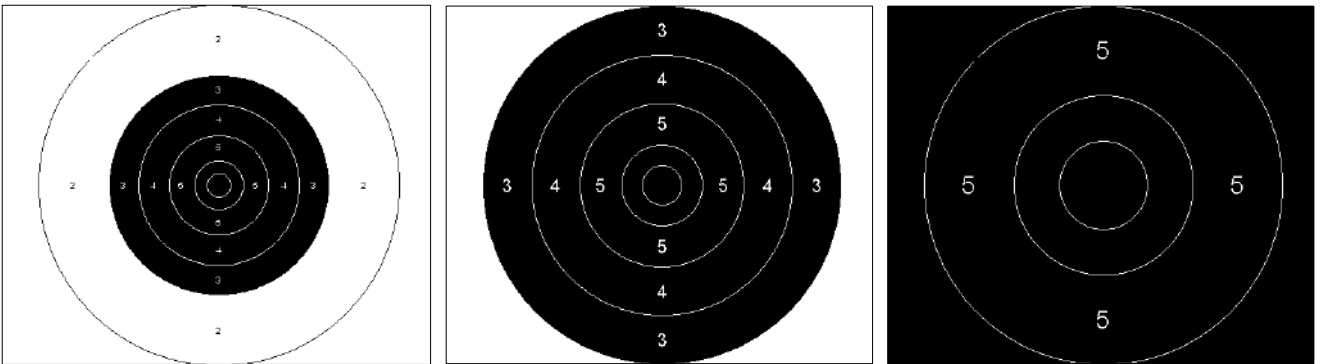

Technical data

Part No	735-0097-97-0201
Size	17 kb
Gauge (default)	7,62 mm
Aiming mark diameter	1120 mm
Manufacture	
Manufacture Part No	

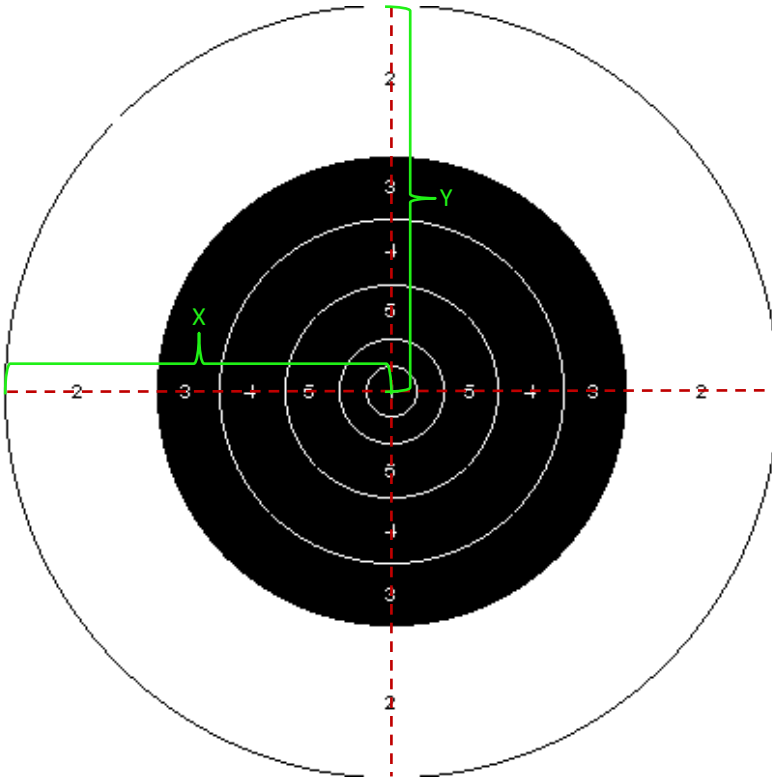

Diameter (mm)	Value
127	X
255	V
510	5
815	4
1120	3
1830	2
ROT	1

X	915 mm
Y	915 mm

Zoom levels

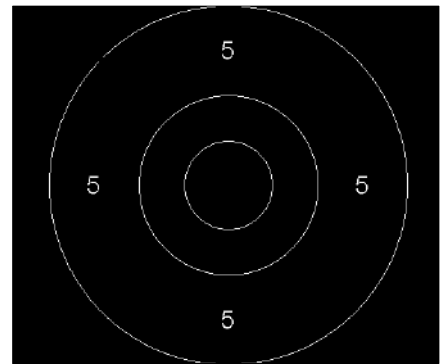
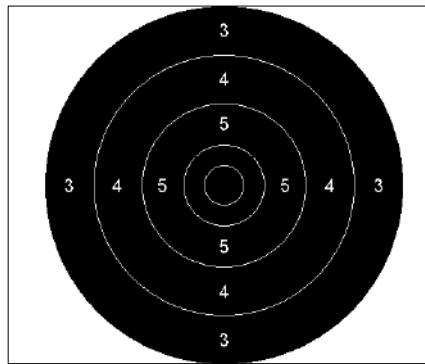
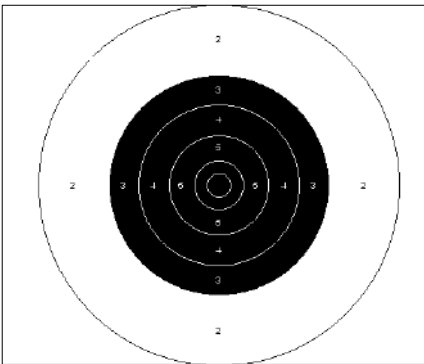

Technical data

Part No	735-0097-97-0202
Size	17 kb
Gauge (default)	7,62 mm
Aiming mark diameter	1120 mm
Manufacture	
Manufacture Part No	

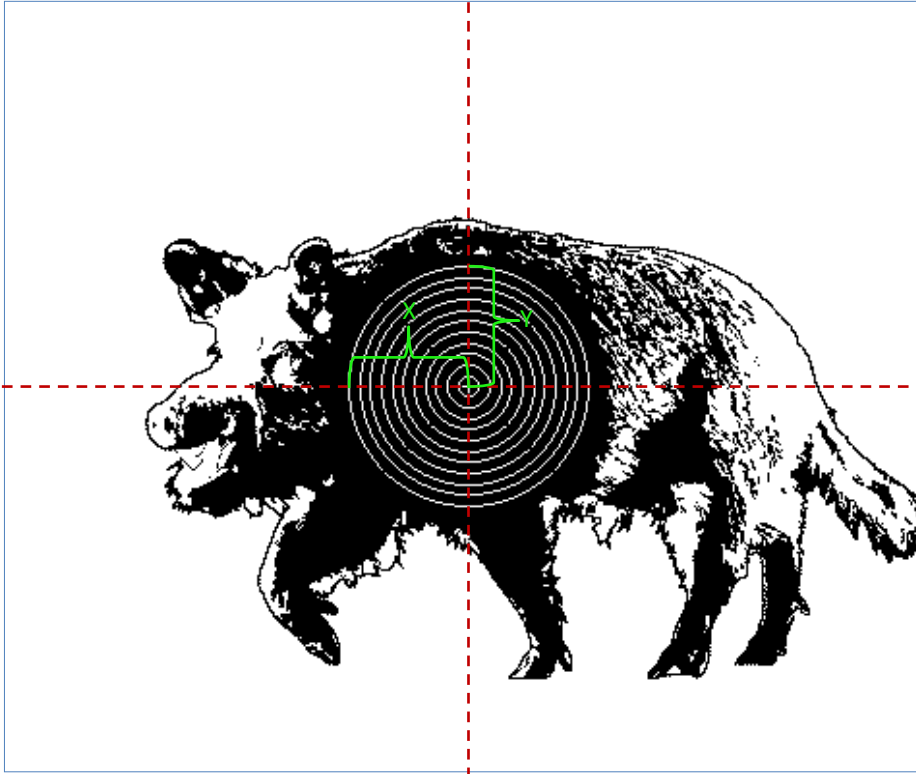

Diameter (mm)	Value
31,8	*
63,6	X
95,4	9
127,2	8
159	7
191	6
222,8	5
254,6	4
286,4	3
318	2
350	1

X	175 mm
Y	175 mm

Zoom levels

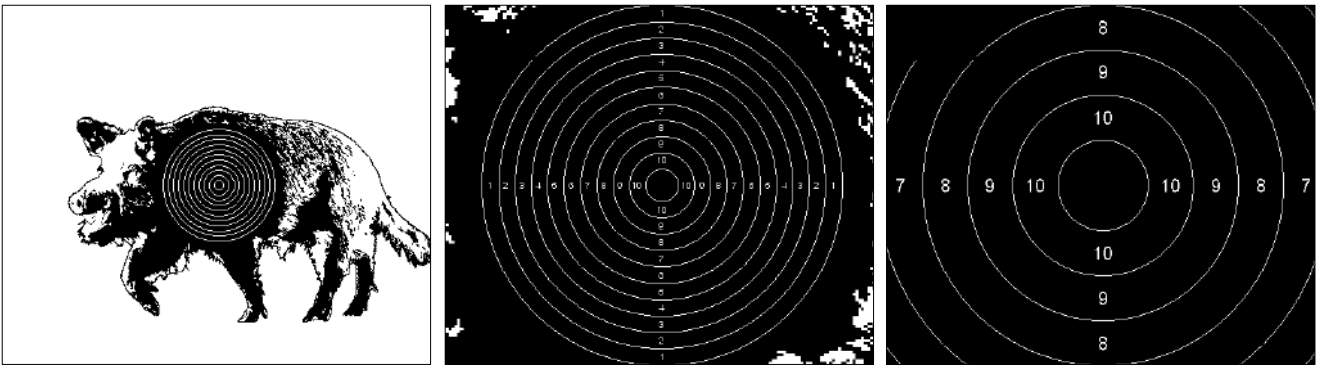

Technical data

Part No	735-0097-97-0206
Size	28 kb
Gauge (default)	8 mm
Aiming mark diameter	350 mm
Manufacture	BOJ
Manufacture Part No	BOJ-Villsvin

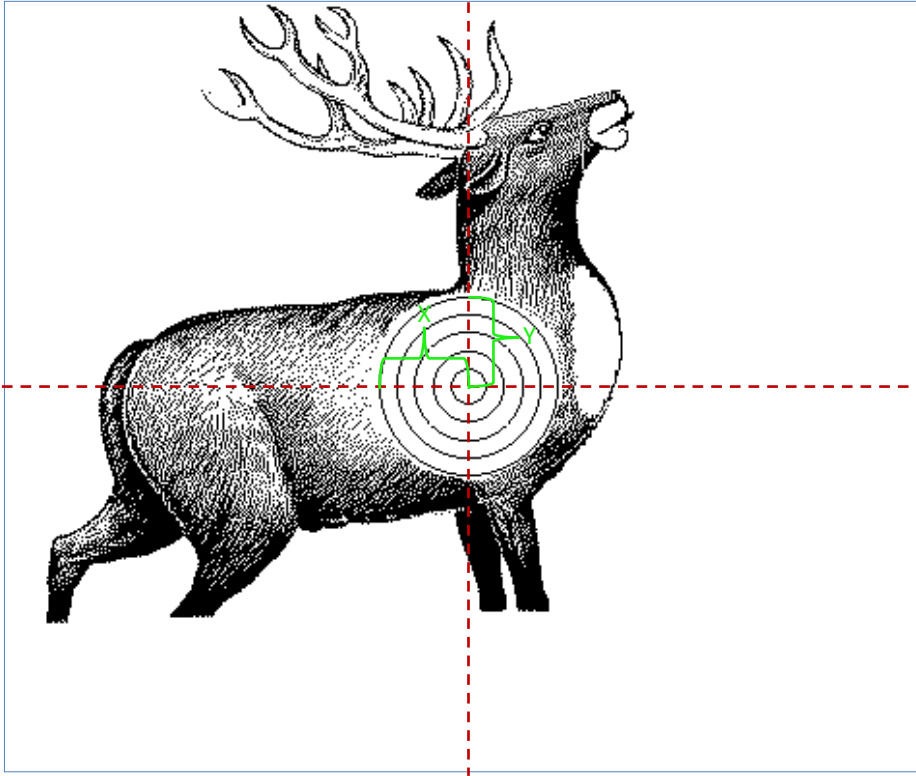

Diameter (mm)	Value
56,6	5
113,2	4
169,8	3
226,4	2
283	1

X	141,5 mm
Y	141,5 mm

Zoom levels

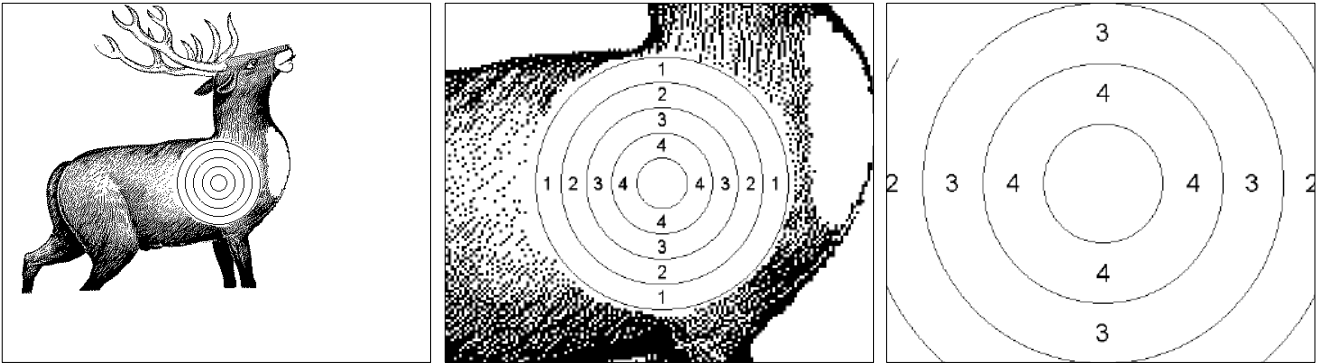

Technical data

Part No	735-0097-97-0207
Size	48 kb
Gauge (default)	8 mm
Aiming mark diameter	283 mm
Manufacture	BOJ
Manufacture Part No	BOJ-Hjort

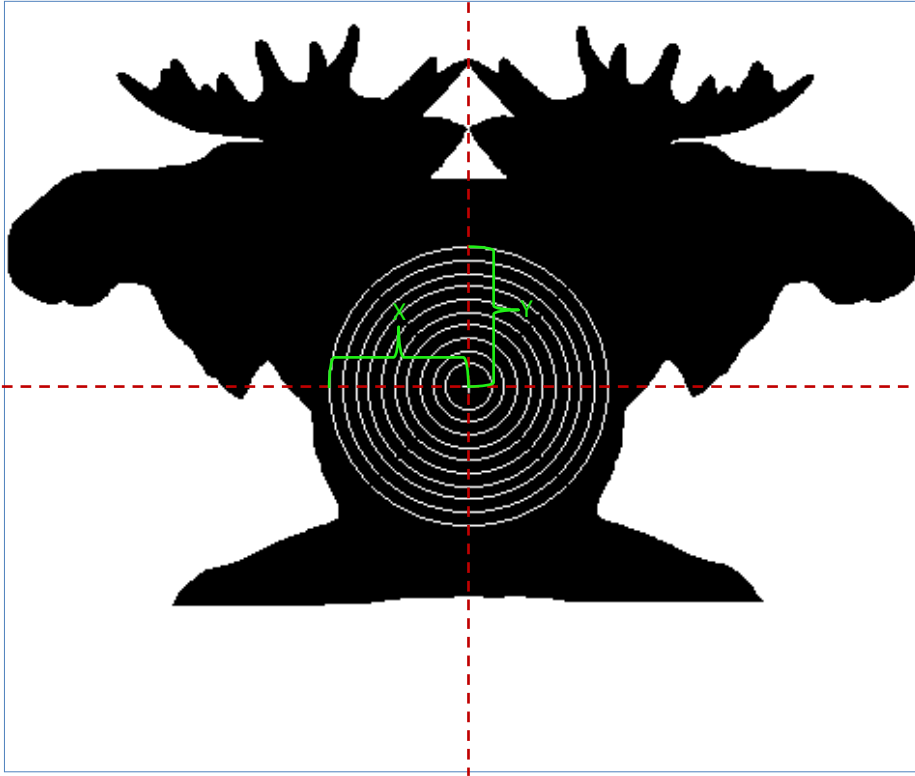

Diameter (mm)	Value
110	X
170	9
230	8
290	7
350	6
410	5
470	4
530	3
590	2
650	1

X	325 mm
Y	325 mm

Zoom levels

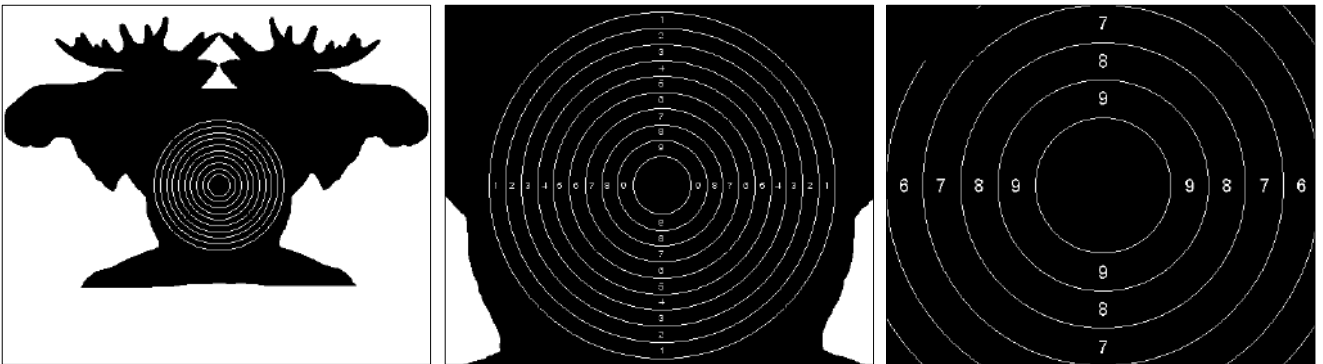

Technical data

Part No	735-0097-97-0208
Size	21 kb
Gauge (default)	8 mm
Aiming mark diameter	650 mm
Manufacture	
Manufacture Part No	

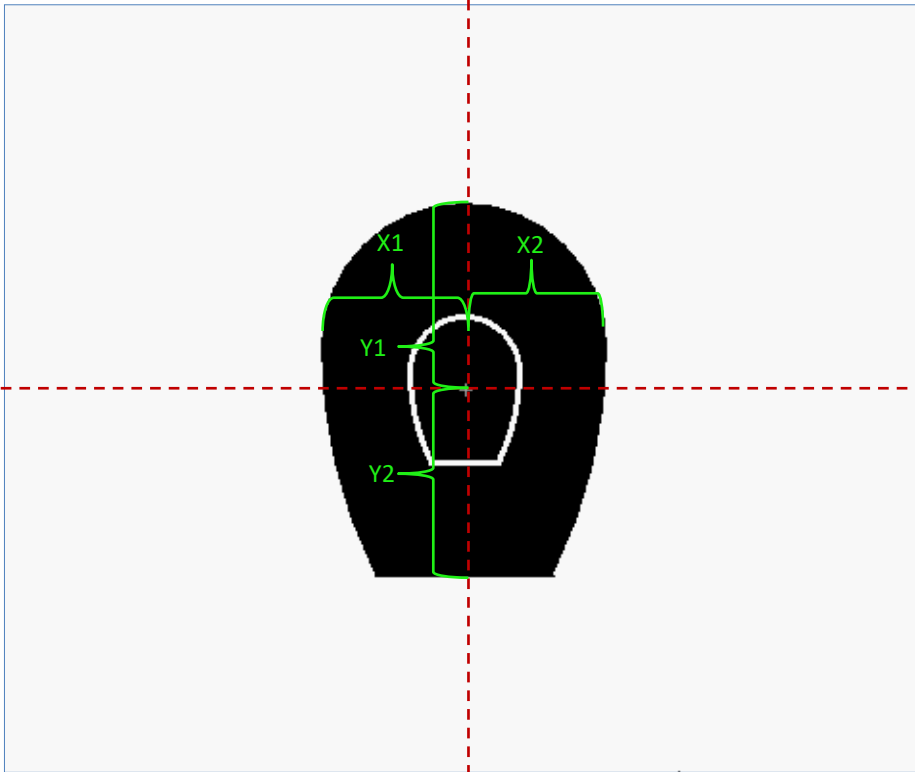

Diameter (mm)	Value

X1	254 mm	X2	254 mm
Y1	330 mm	Y2	326 mm

Zoom levels

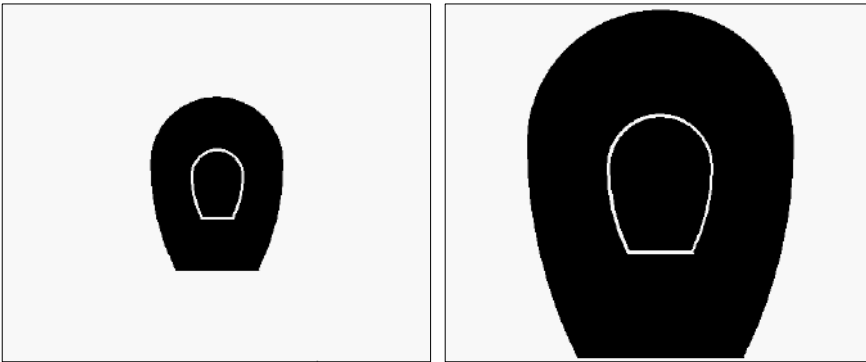

Technical data

Part No	735-0097-97-0209
Size	56 kB
Gauge (default)	8 mm
Aiming mark diameter	
Manufacture	
Manufacture Part No	

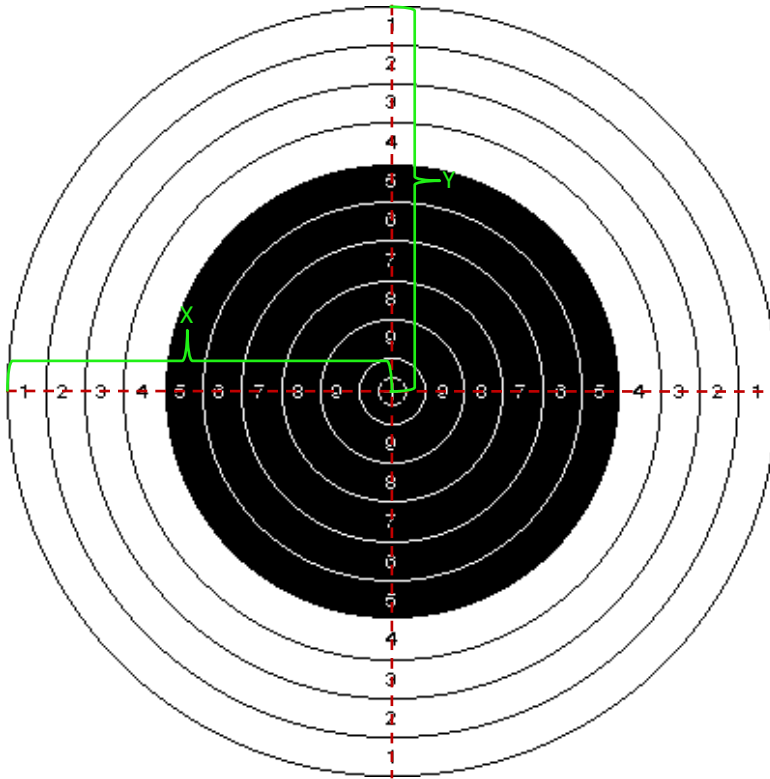

Diameter (mm)	Value
11,59	*
28,25	X
61,59	9
94,92	8
128,25	7
161,59	6
194,92	5
228,25	4
261,59	3
294,92	2
328,25	1

X	164,125 mm
Y	164,125 mm

Zoom levels

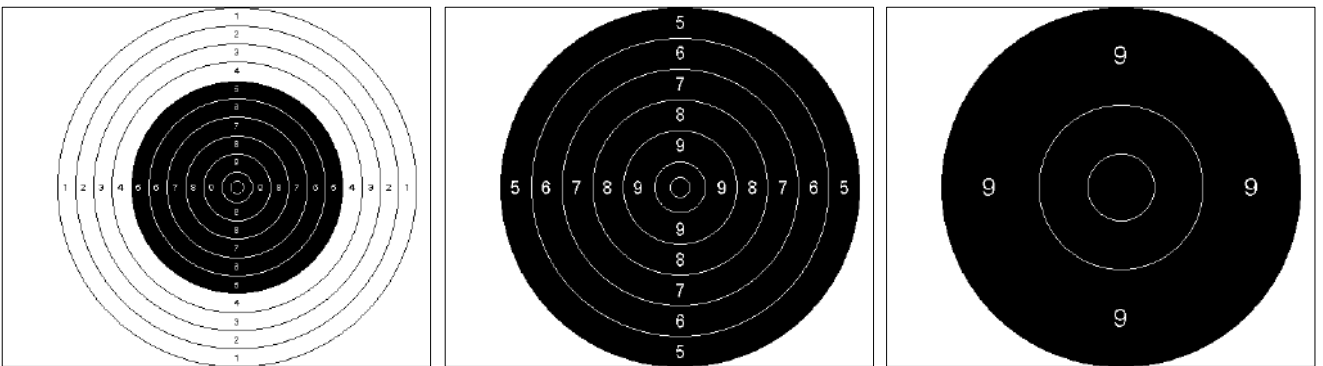

Technical data

Part No	735-0097-97-0210
Size	N/A
Gauge (default)	8 mm
Aiming mark diameter	194,92 mm
Manufacture	
Manufacture Part No	

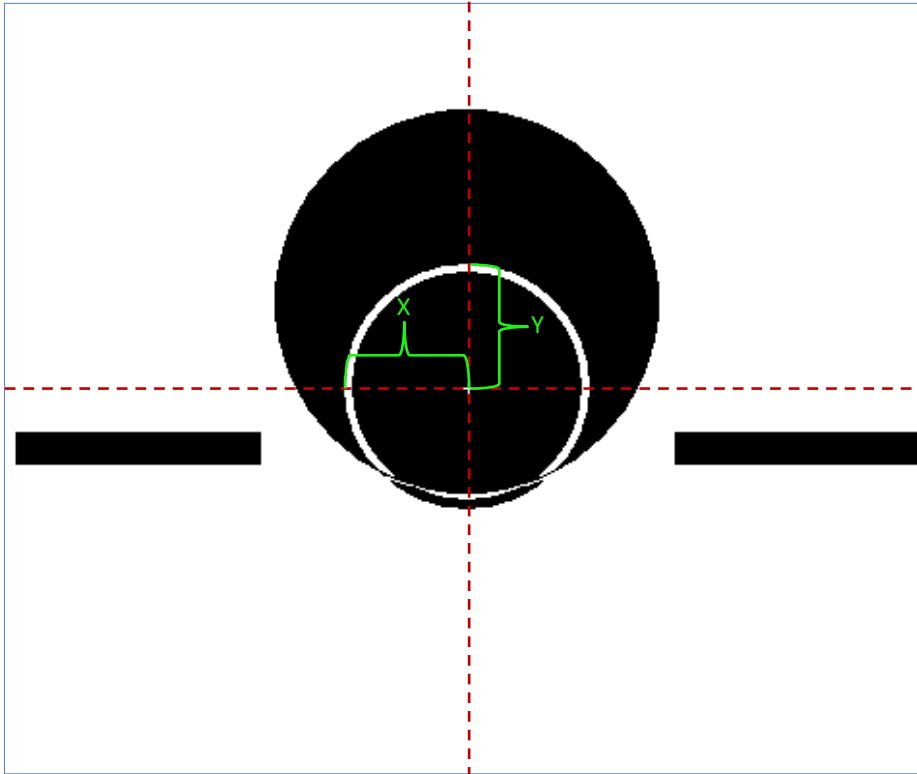

Diameter (mm)	Value

X	80 mm
Y	80 mm

Zoom levels

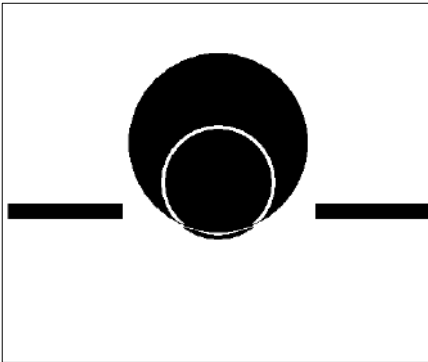

Technical data

Part No	735-0097-97-0211
Size	14 kb
Gauge (default)	8 mm
Aiming mark diameter	
Manufacture	
Manufacture Part No	

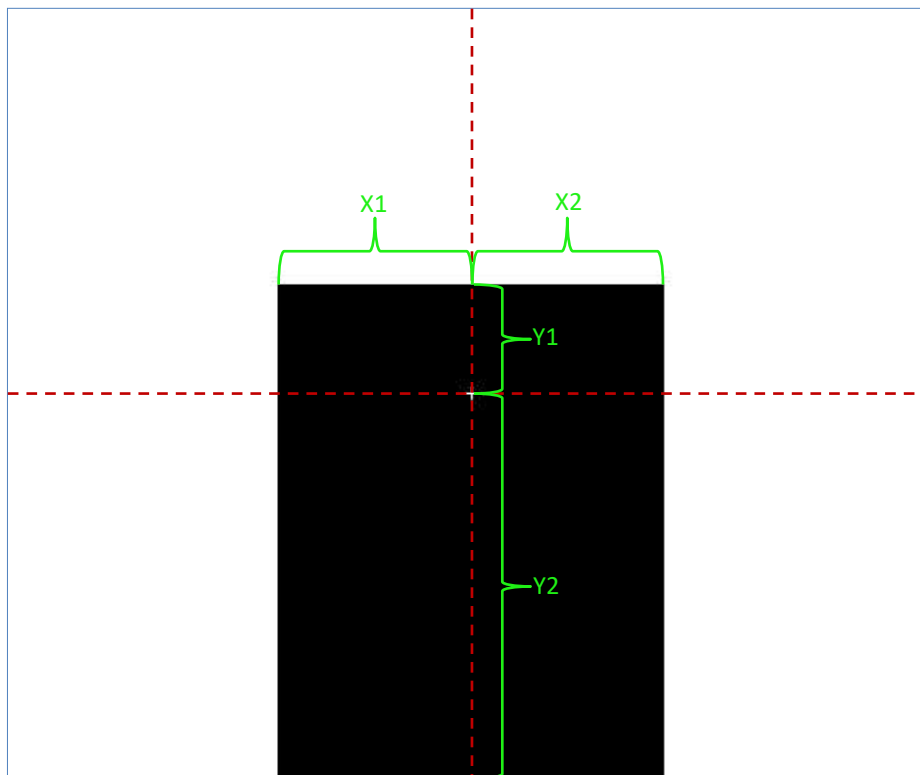

Diameter (mm)	Value

X2	125 mm	X2	125 mm
Y1	70 mm	Y2	250 mm

Zoom levels

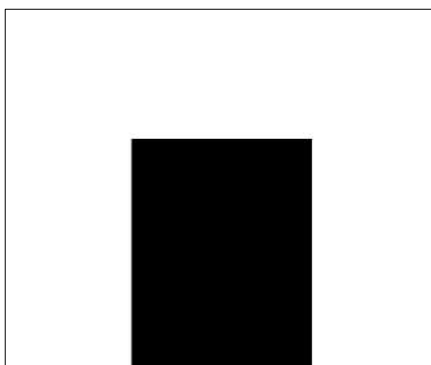

Technical data

Part No	735-0097-97-0212
Size	13 kb
Gauge (default)	8 mm
Aiming mark diameter	
Manufacture	
Manufacture Part No	

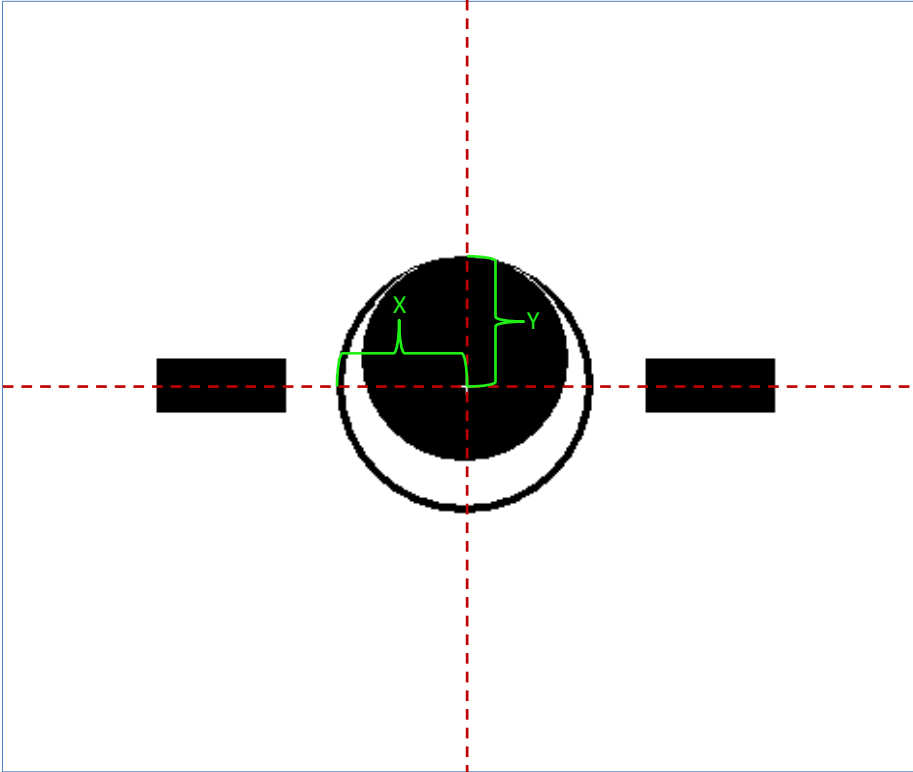

Diameter (mm)	Value

X	50 mm
Y	50 mm

Zoom levels

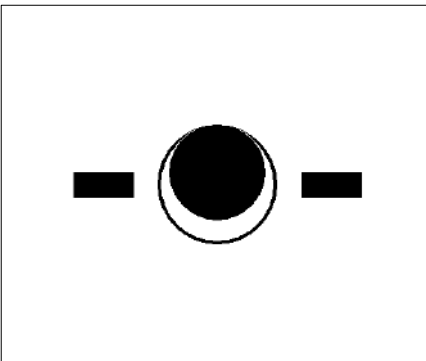

Technical data

Part No	735-0097-97-0213
Size	14 kb
Gauge (default)	8 mm
Aiming mark diameter	
Manufacture	
Manufacture Part No	

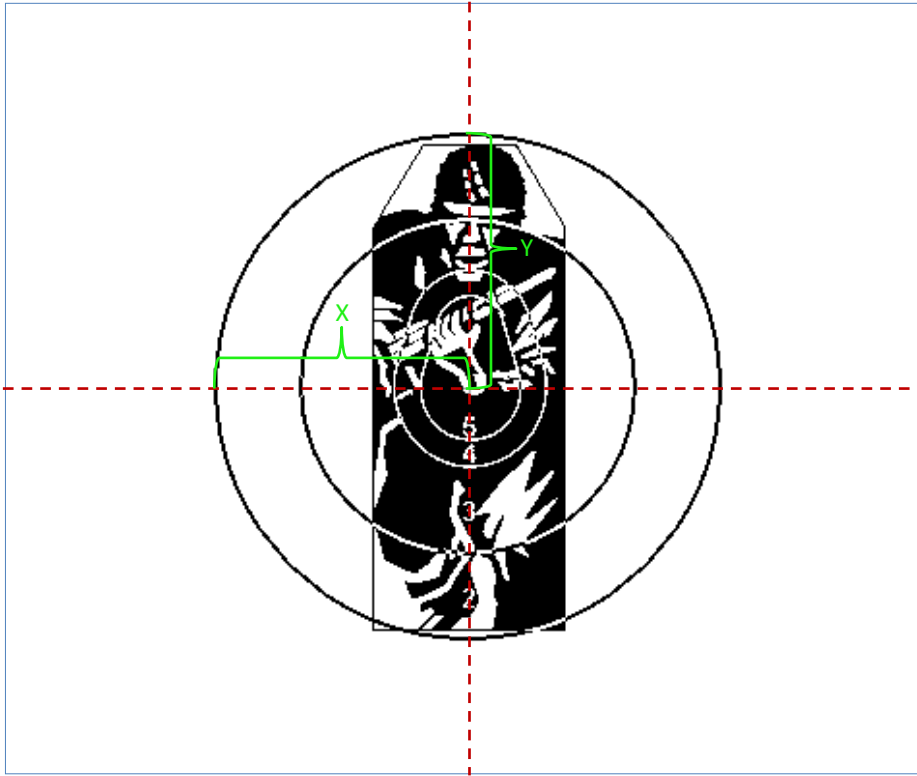

Diameter (mm)	Value
800	3
1200	2

X	600 mm
Y	600 mm

Zoom levels

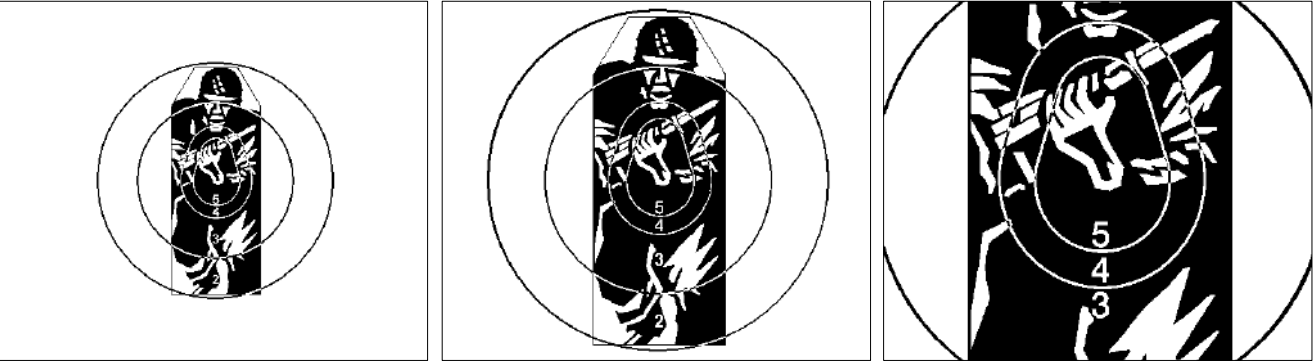

Technical data

Part No	735-0097-97-0214
Size	132 kb
Gauge (default)	7,62 mm
Aiming mark diameter	
Manufacture	
Manufacture Part No	

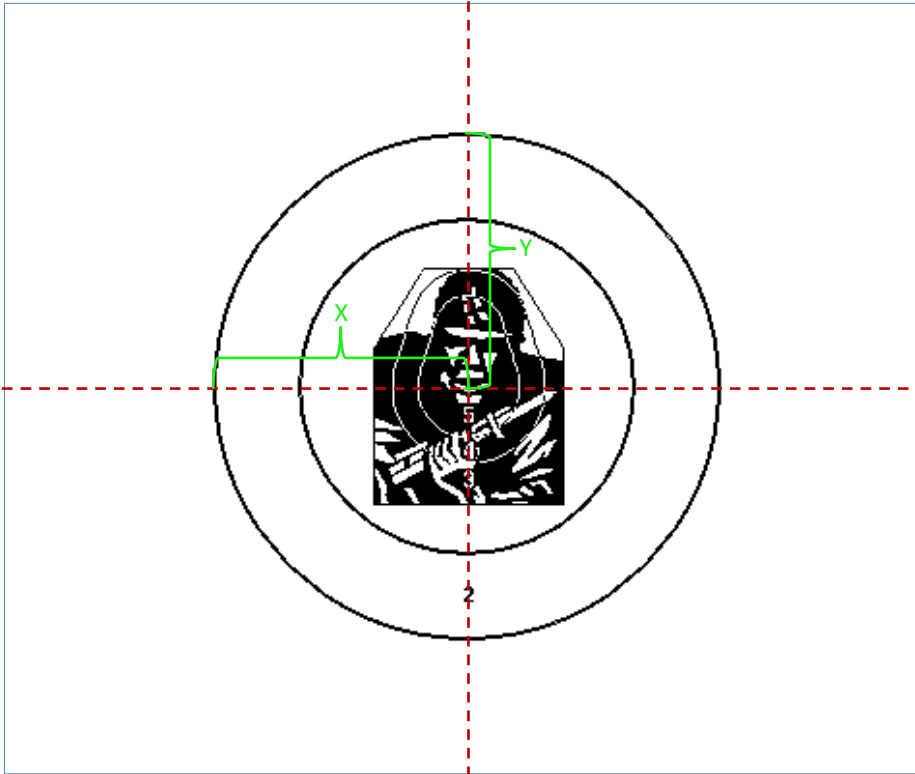

Diameter (mm)	Value
800	3
1200	2

X	600 mm
Y	600 mm

Zoom levels



Technical data

Part No	735-0097-97-0215
Size	122 kb
Gauge (default)	7,62 mm
Aiming mark diameter	
Manufacture	
Manufacture Part No	

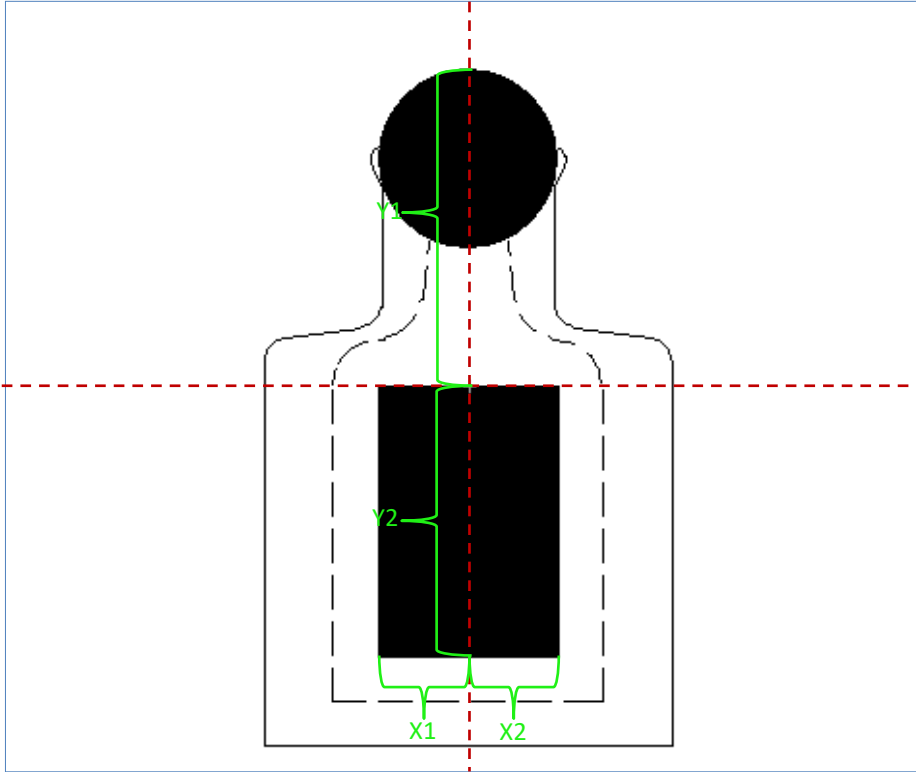

Diameter (mm)	Value

X1	100 mm	X2	100 mm
Y1	350 mm	Y2	300 mm

Zoom levels

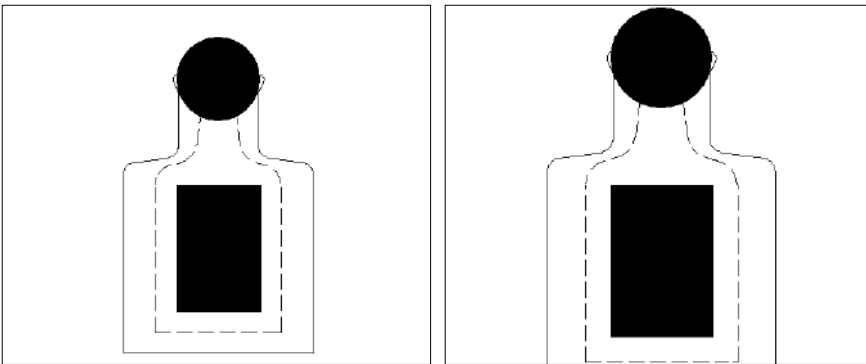

Technical data

Part No	735-0097-97-0216
Size	46 kb
Gauge (default)	8 mm
Aiming mark diameter	
Manufacture	
Manufacture Part No	



Diameter (mm)	Value
35	X
70	6
140	5
280	4
420	3
600	2
ROT	1

X	300 mm
Y	300 mm

Zoom levels

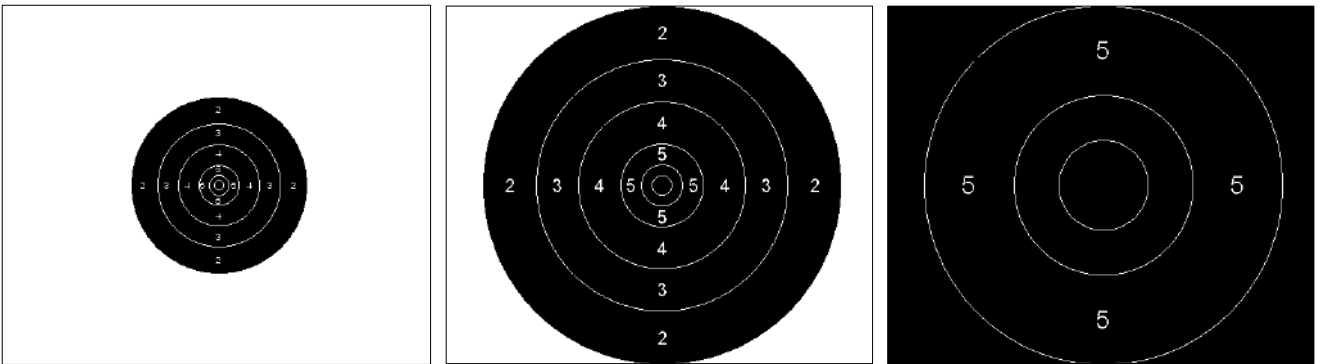

Technical data

Part No	735-0097-97-0217
Size	18 kb
Gauge (default)	7,62 mm
Aiming mark diameter	600 mm
Manufacture	
Manufacture Part No	

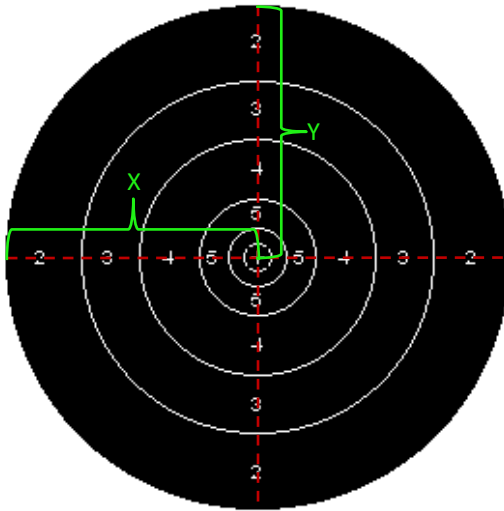

Diameter (mm)	Value
46	X
93	6
186	5
373	4
56	3
800	2
ROT	1

X	400 mm
Y	400 mm

Zoom levels

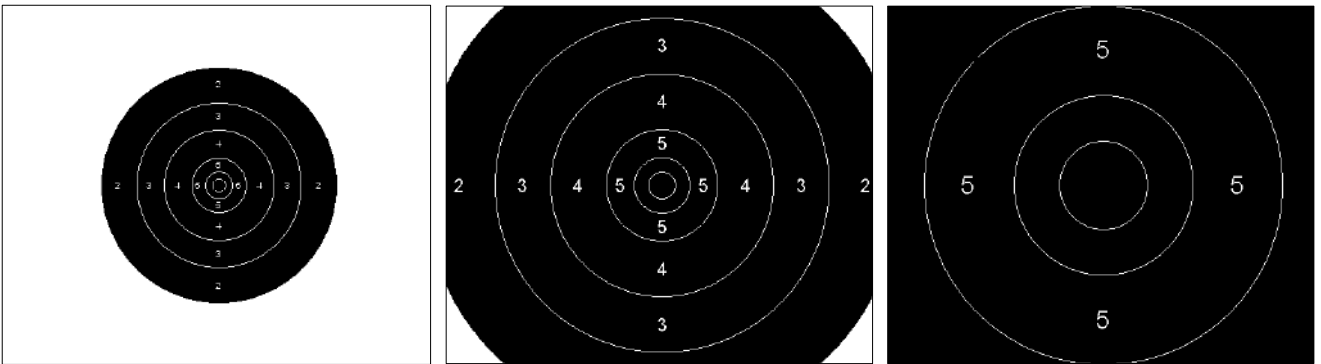

Technical data

Part No	735-0097-97-0218
Size	18 kb
Gauge (default)	7,62 mm
Aiming mark diameter	800 mm
Manufacture	
Manufacture Part No	

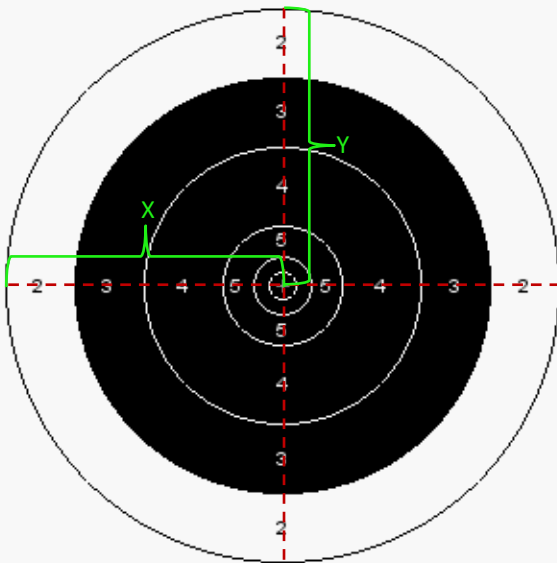

Diameter (mm)	Value
72	X
145	6
290	5
660	4
1000	3
1320	2
ROT	1

X	660 mm
Y	660 mm

Zoom levels



Technical data

Part No	735-0097-97-0219
Size	18 kb
Gauge (default)	7,62 mm
Aiming mark diameter	1000 mm
Manufacture	
Manufacture Part No	

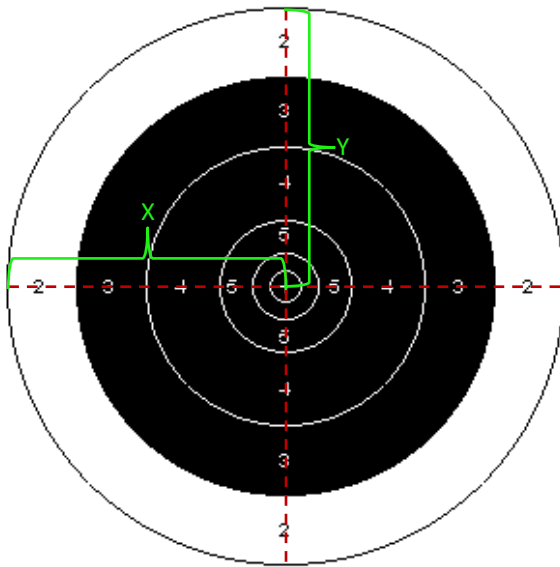

Diameter (mm)	Value
80	X
160	6
320	5
660	4
1000	3
1320	2
ROT	1

X	660 mm
Y	660 mm

Zoom levels

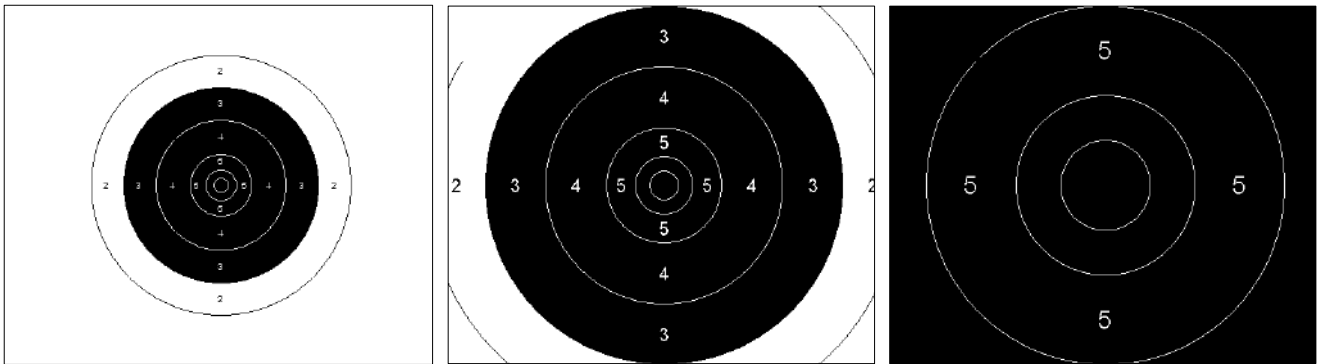

Technical data

Part No	735-0097-97-0220
Size	18 kb
Gauge (default)	7,62 mm
Aiming mark diameter	1000 mm
Manufacture	
Manufacture Part No	

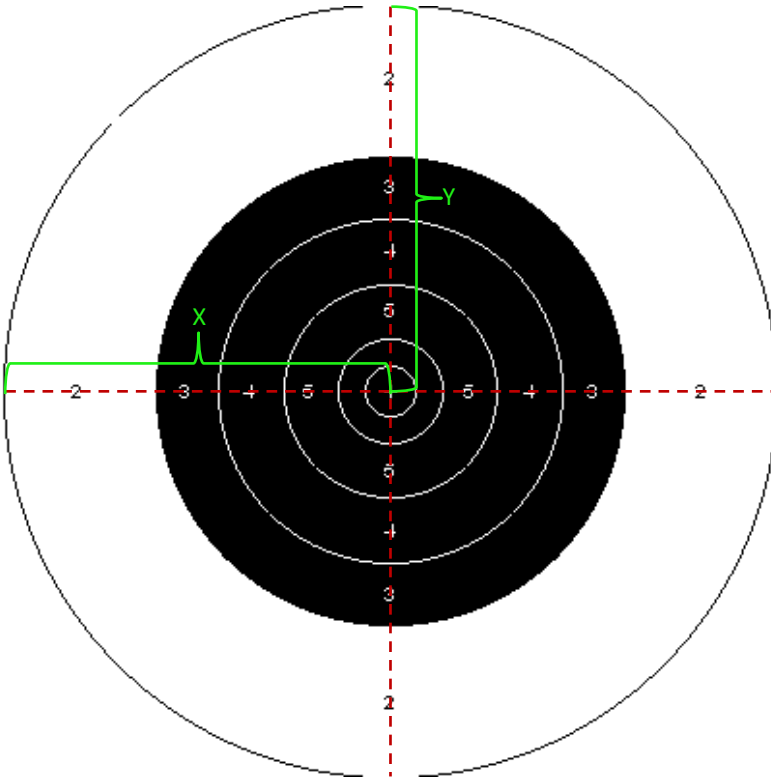

Diameter (mm)	Value
127	X
255	6
510	5
815	4
1120	3
1830	2
ROT	1

X	915 mm
Y	915 mm

Zoom levels

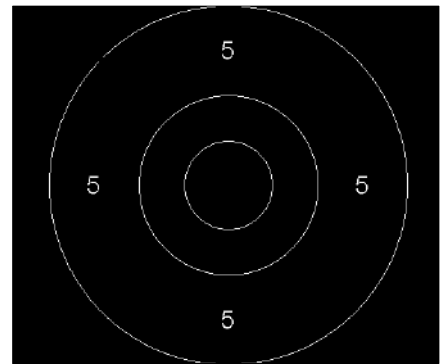
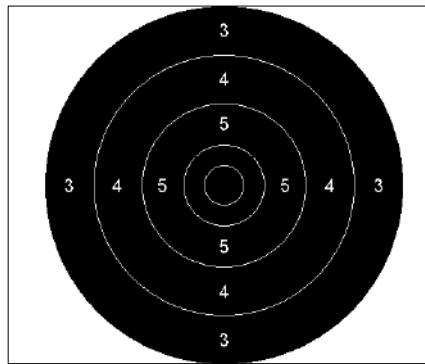
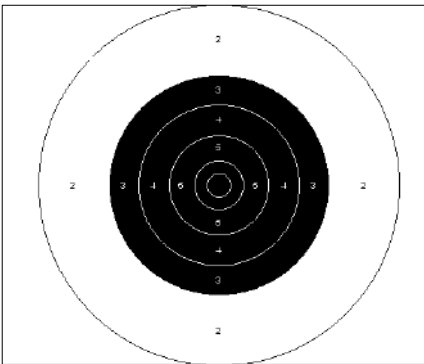

Technical data

Part No	735-0097-97-0221
Size	16 kb
Gauge (default)	7,62 mm
Aiming mark diameter	1120 mm
Manufacture	
Manufacture Part No	

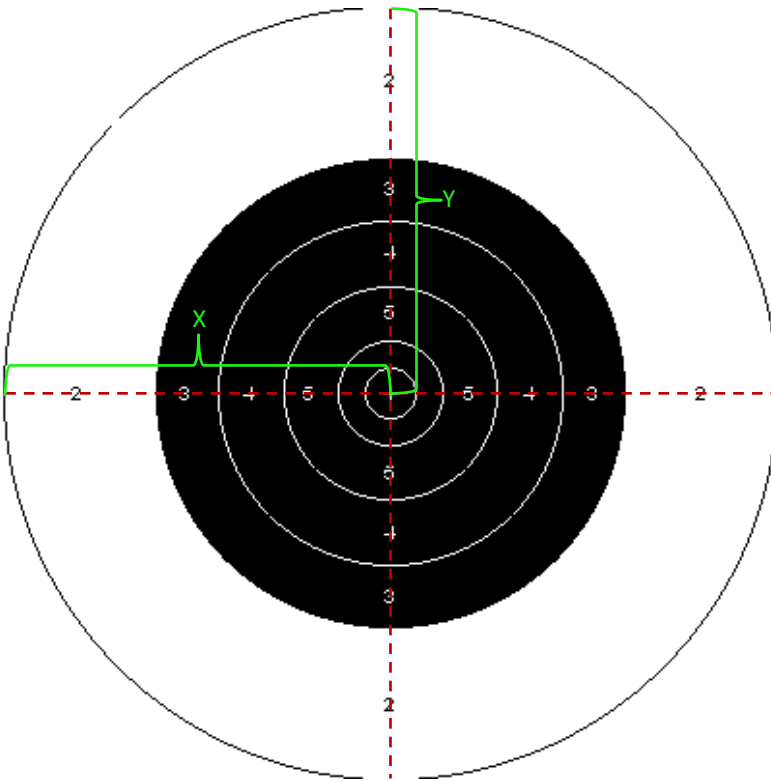

Diameter (mm)	Value
127	X
255	6
510	5
815	4
1120	3
1830	2
ROT	1

X	915 mm
Y	915 mm

Zoom levels

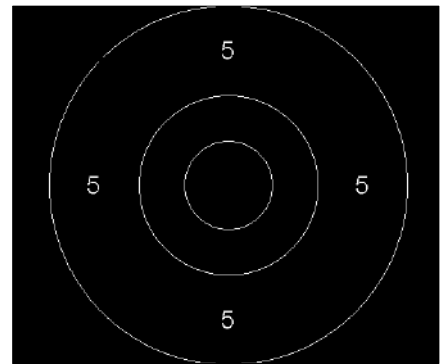
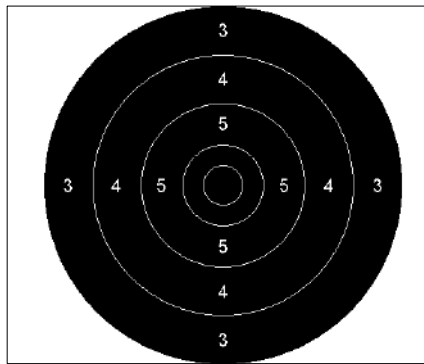
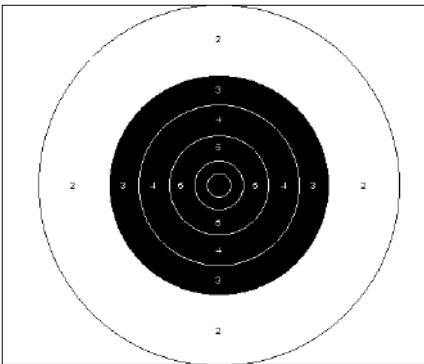

Technical data

Part No	735-0097-97-0222
Size	16 kb
Gauge (default)	7,62 mm
Aiming mark diameter	1120 mm
Manufacture	
Manufacture Part No	

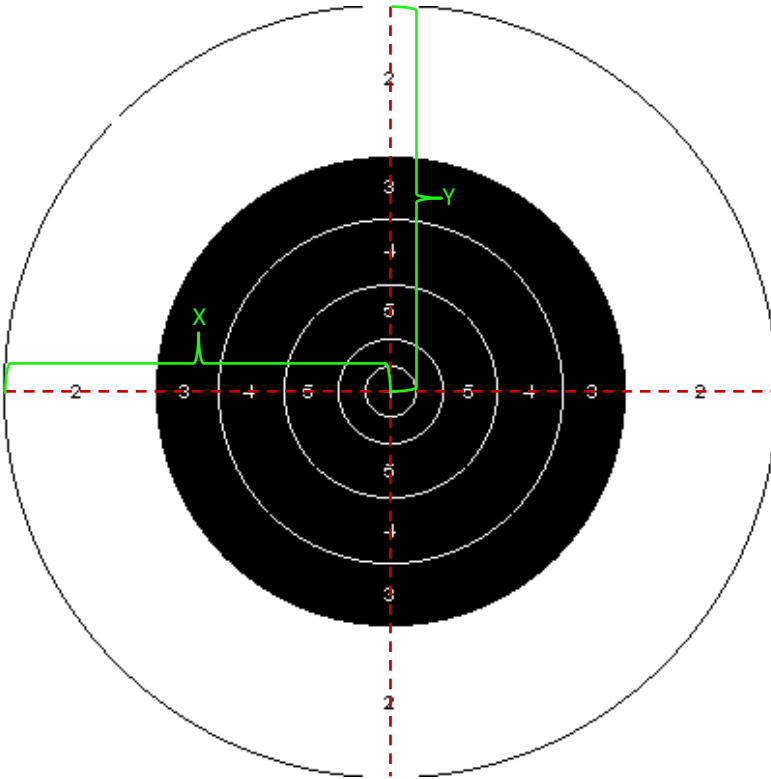

Diameter (mm)	Value
127	X
255	6
510	5
815	4
1120	3
1830	2
ROT	1

X	915 mm
Y	915 mm

Zoom levels

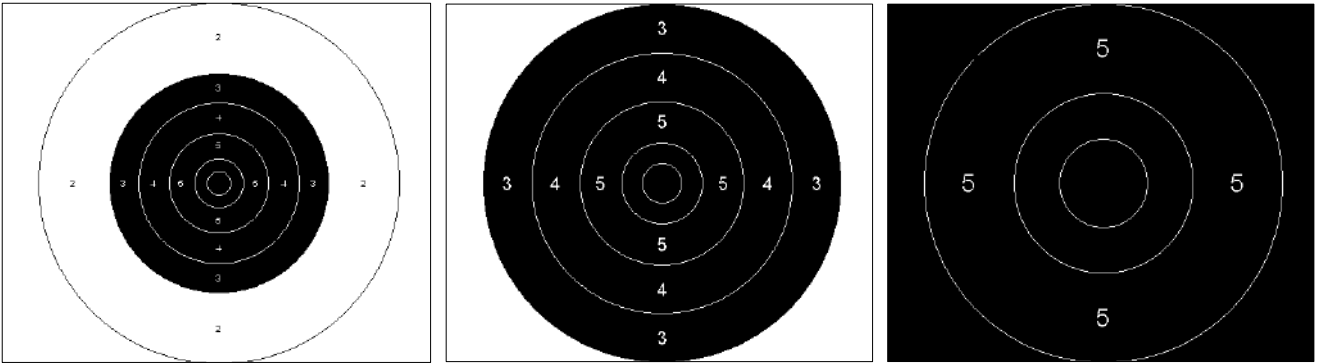

Technical data

Part No	735-0097-97-0223
Size	16 kb
Gauge (default)	7,62 mm
Aiming mark diameter	1120 mm
Manufacture	
Manufacture Part No	

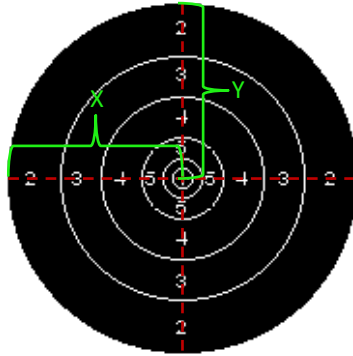

Diameter (mm)	Value
32	X
65	X
130	5
260	4
390	3
560	2
ROT	1

X	280 mm
Y	280 mm

Zoom levels

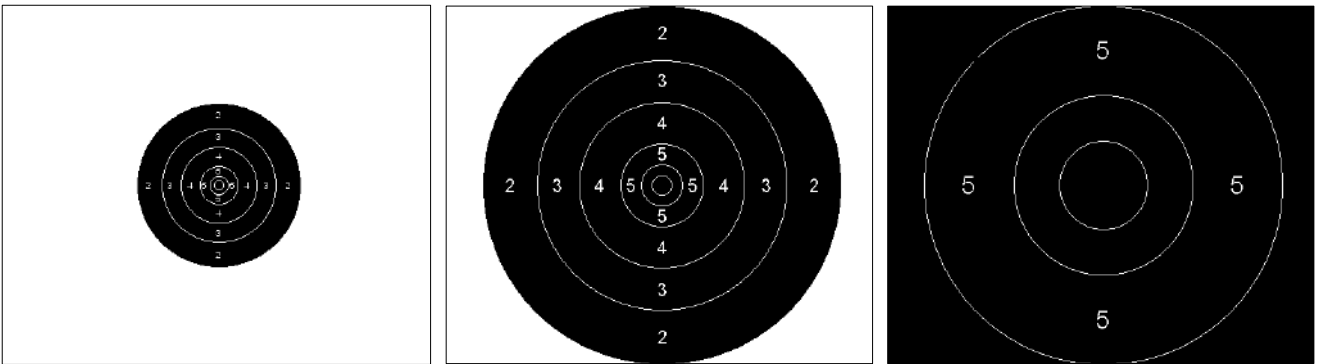

Technical data

Part No	735-0097-97-0224
Size	18 kb
Gauge (default)	7,62 mm
Aiming mark diameter	560 mm
Manufacture	
Manufacture Part No	

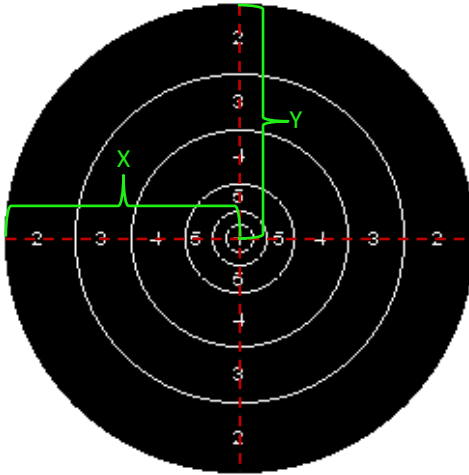

Diameter (mm)	Value
43	X
86	X
173	5
346	4
520	3
746	2
ROT	1

X	373 mm
Y	373 mm

Zoom levels

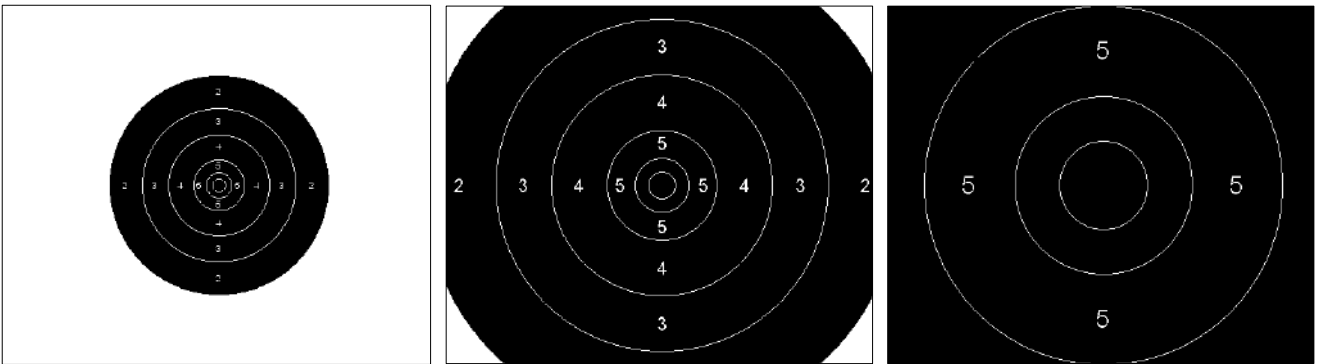

Technical data

Part No	735-0097-97-0225
Size	18 kb
Gauge (default)	7,62 mm
Aiming mark diameter	746 mm
Manufacture	
Manufacture Part No	

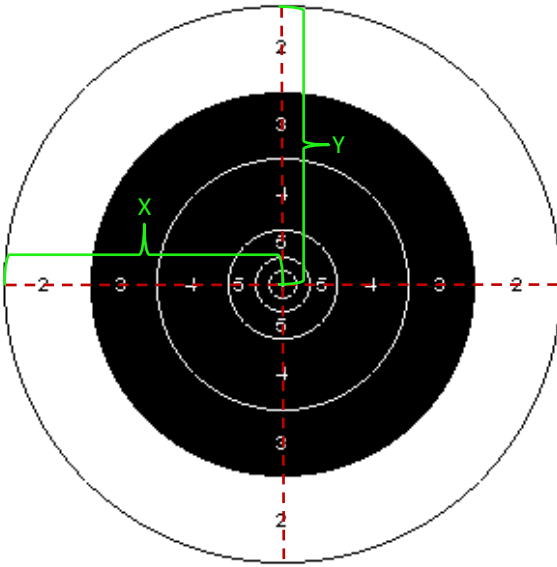

Diameter (mm)	Value
65	X
130	X
260	5
600	4
915	3
1320	2
ROT	1

X	660 mm
Y	660 mm

Zoom levels

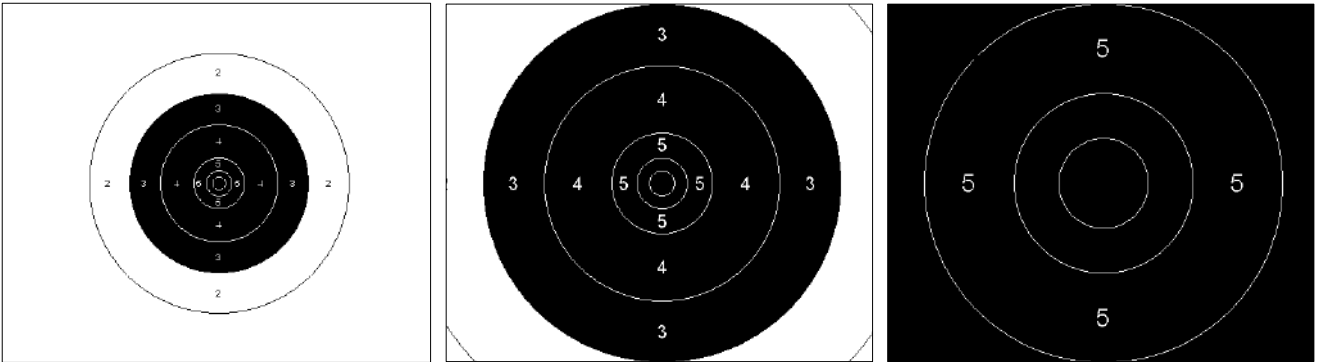

Technical data

Part No	735-0097-97-0226
Size	18 kb
Gauge (default)	7,62 mm
Aiming mark diameter	915 mm
Manufacture	
Manufacture Part No	

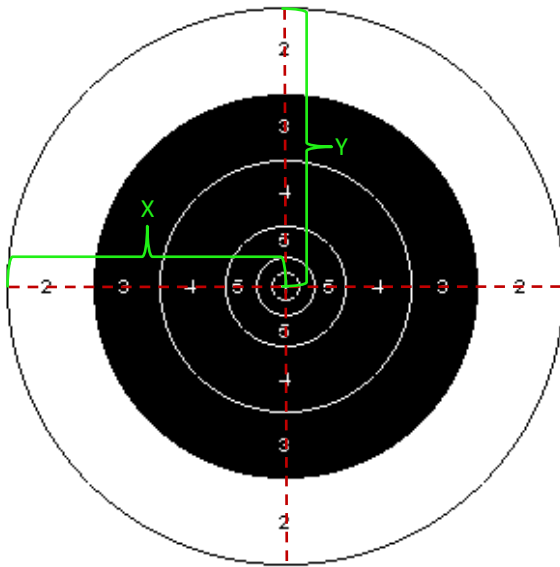

Diameter (mm)	Value
72	X
145	X
290	5
600	4
915	3
1320	2
ROT	1

X	660 mm
Y	660 mm

Zoom levels

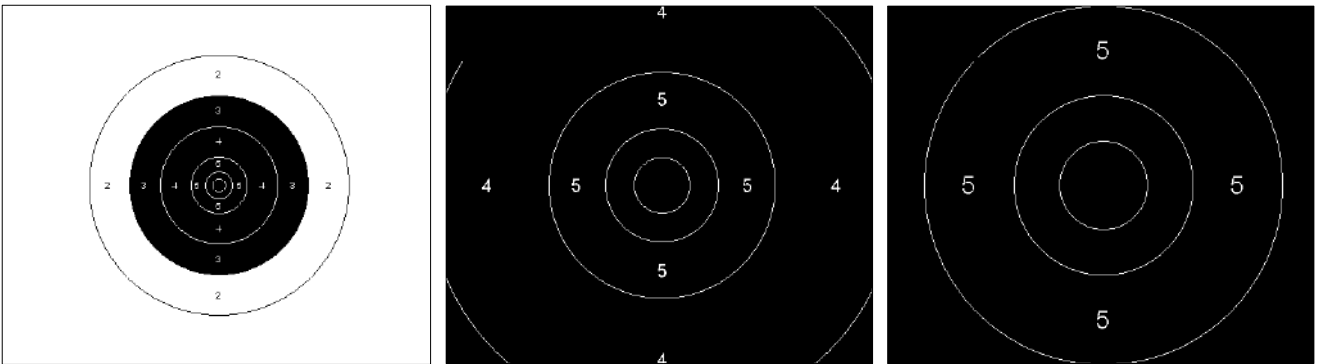

Technical data

Part No	735-0097-97-0227
Size	18 kb
Gauge (default)	7,62 mm
Aiming mark diameter	915 mm
Manufacture	
Manufacture Part No	

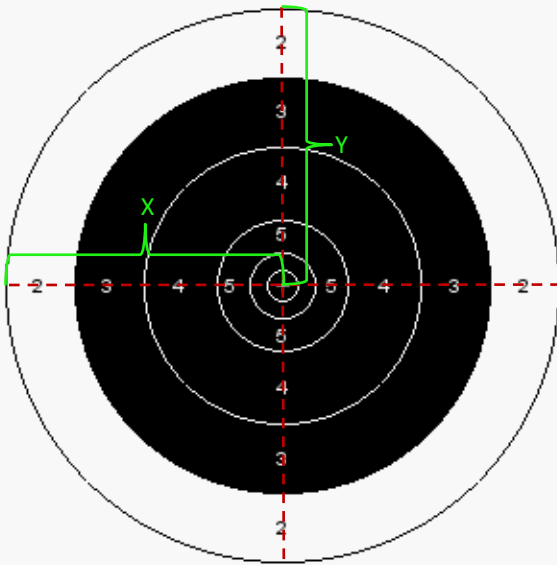

Diameter (mm)	Value
80	X
160	X
320	5
660	4
1000	3
1320	2
ROT	1

X	660 mm
Y	660 mm

Zoom levels

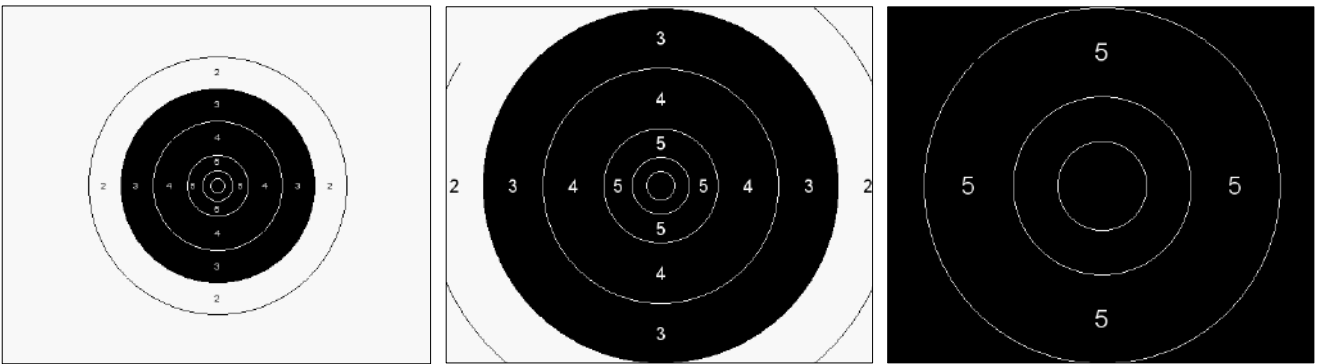

Technical data

Part No	735-0097-97-0228
Size	18 kb
Gauge (default)	7,62 mm
Aiming mark diameter	1000 mm
Manufacture	
Manufacture Part No	

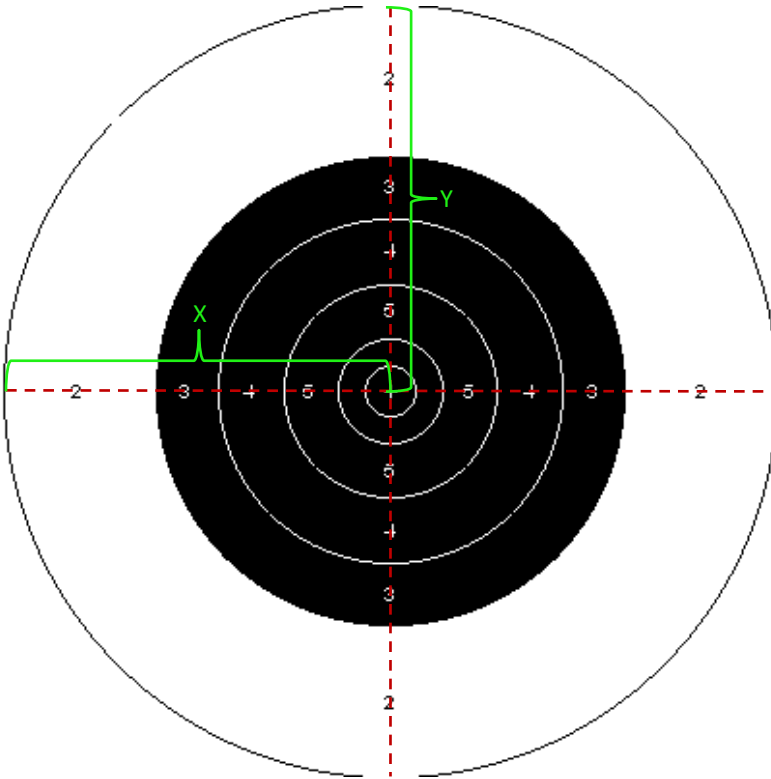

Diameter (mm)	Value
127	X
255	X
510	5
815	4
1120	3
1830	2
ROT	1

X	915 mm
Y	915 mm

Zoom levels

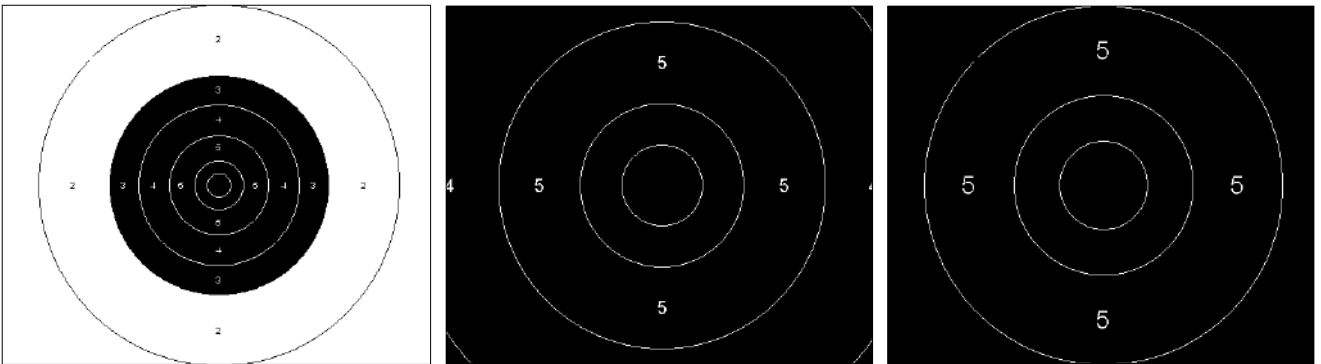

Technical data

Part No	735-0097-97-0229
Size	16 kb
Gauge (default)	7,62 mm
Aiming mark diameter	1120 mm
Manufacture	
Manufacture Part No	

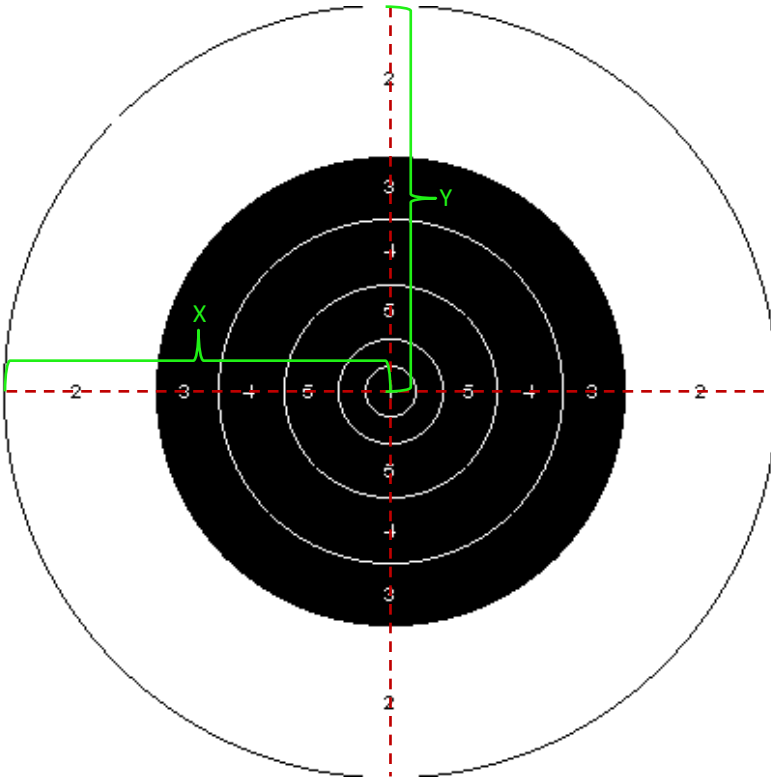

Diameter (mm)	Value
127	X
255	X
510	5
815	4
1120	3
1830	2
ROT	1

X	915 mm
Y	915 mm

Zoom levels

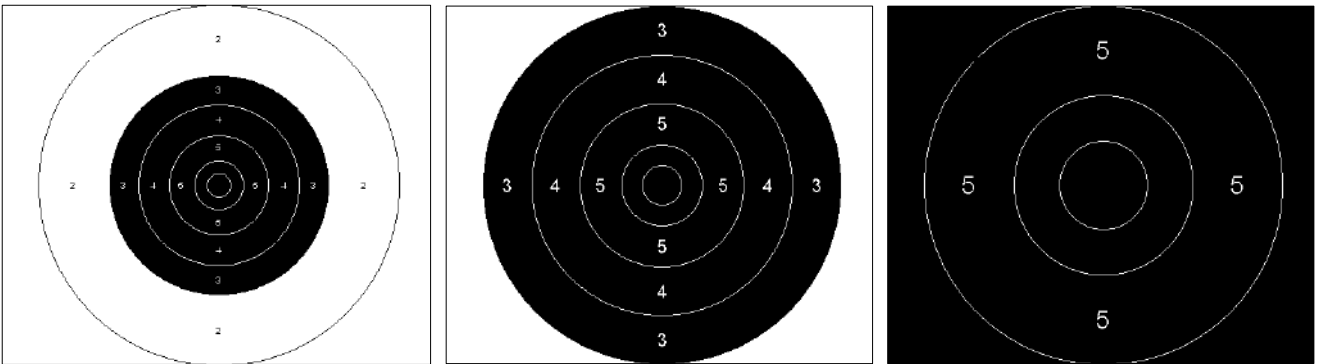

Technical data

Part No	735-0097-97-0230
Size	16 kb
Gauge (default)	7,62 mm
Aiming mark diameter	1120 mm
Manufacture	
Manufacture Part No	

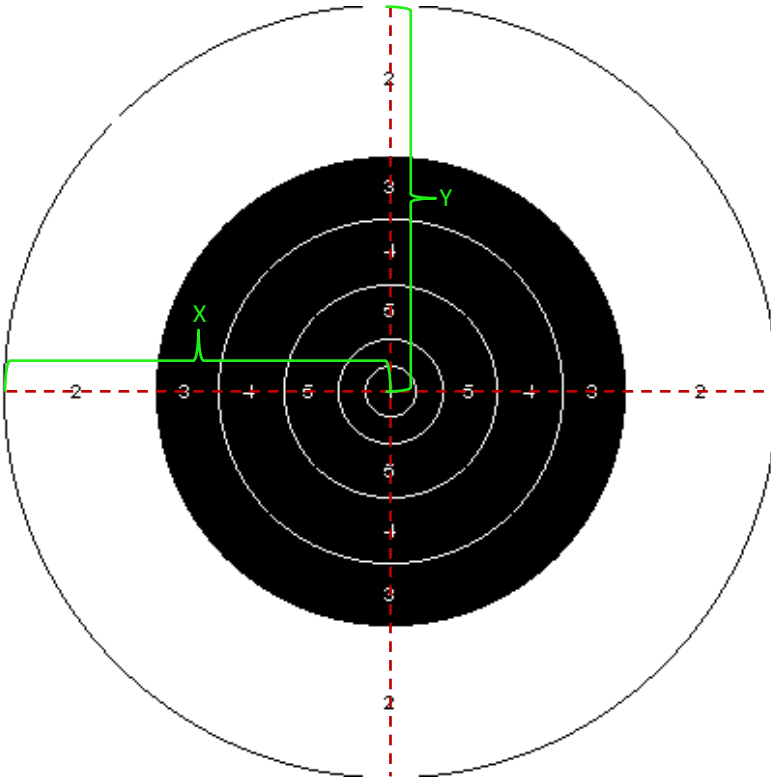

Diameter (mm)	Value
127	X
255	X
510	5
815	4
1120	3
1830	2
ROT	1

X	915 mm
Y	915 mm

Zoom levels

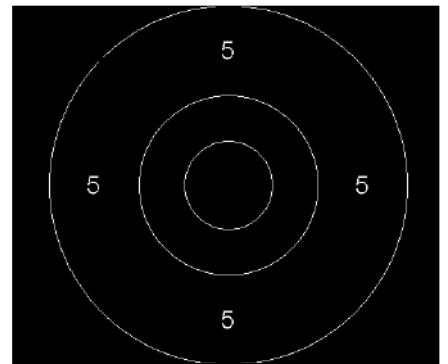
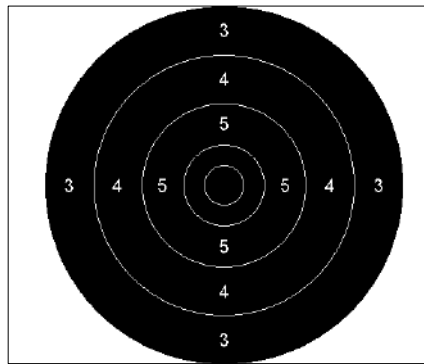
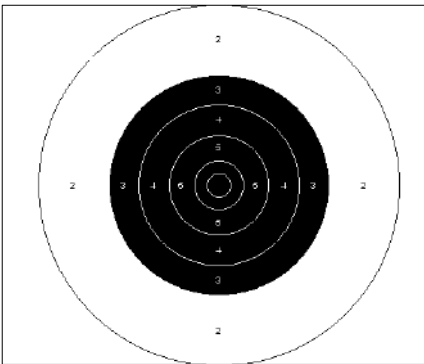

Technical data

Part No	735-0097-97-0231
Size	16 kb
Gauge (default)	7,62 mm
Aiming mark diameter	1120 mm
Manufacture	
Manufacture Part No	

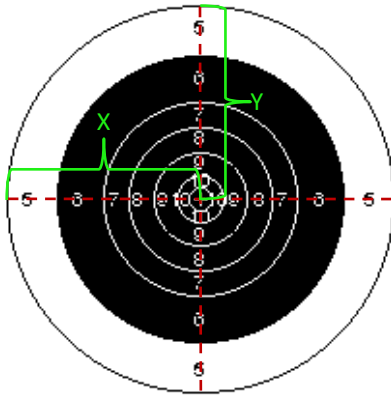

Diameter (mm)	Value
34,68	X
72,39	10
148,59	9
224,79	8
300,99	7
453,39	6
605,79	5

X	302,895 mm
Y	302,895 mm

Zoom levels

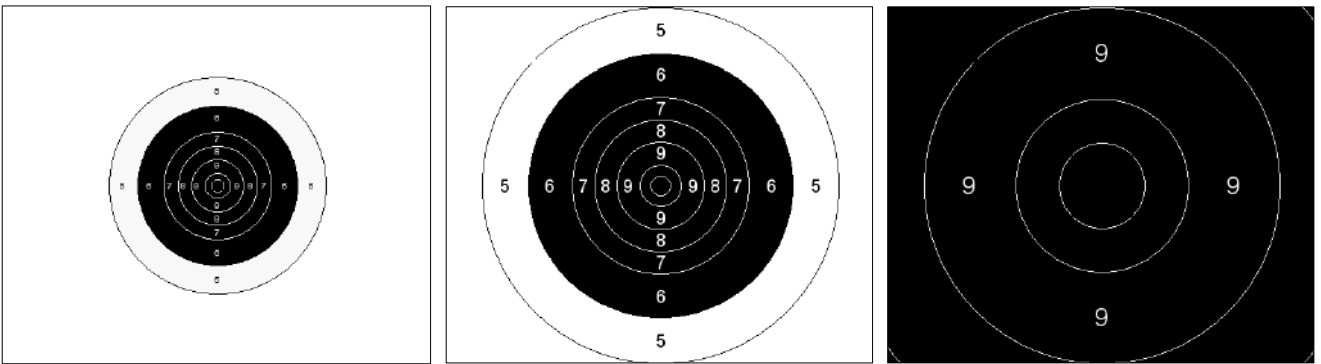

Technical data

Part No	735-0097-97-0232
Size	2 kb
Gauge (default)	7,62 mm
Aiming mark diameter	453,39 mm
Manufacture	
Manufacture Part No	

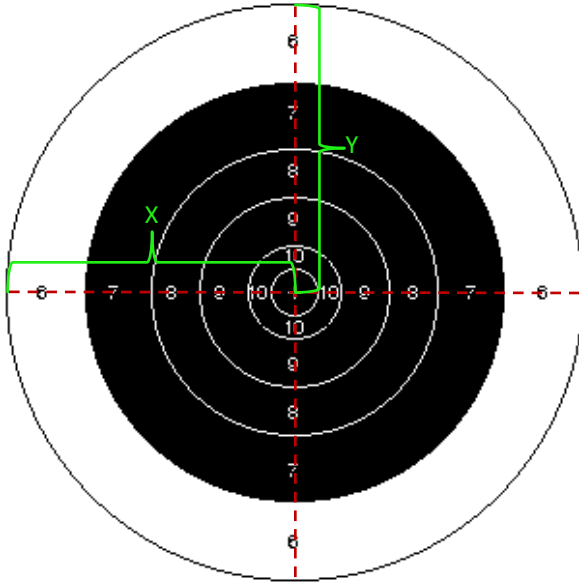

Diameter (mm)	Value
127	X
254	10
508	9
762	8
1117,6	7
1524	6
ROT	5

X	762 mm
Y	762 mm

Zoom levels

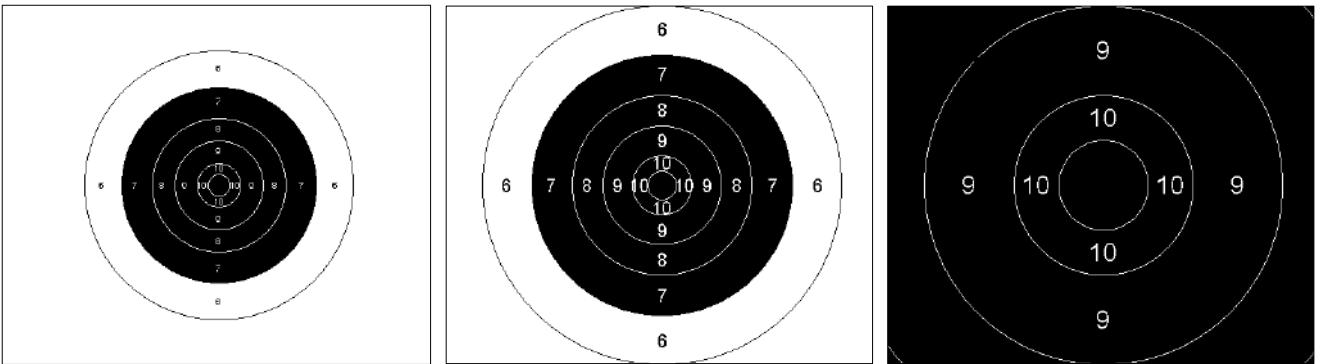

Technical data

Part No	735-0097-97-0233
Size	18 kb
Gauge (default)	7,62 mm
Aiming mark diameter	1117,6 mm
Manufacture	
Manufacture Part No	

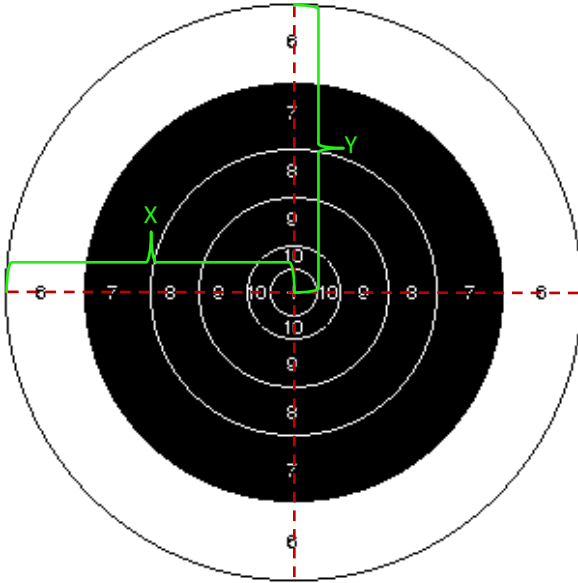

Diameter (mm)	Value
127	X
254	10
508	9
762	8
1117,6	7
1524	6
ROT	5

X	762 mm
Y	762 mm

Zoom levels

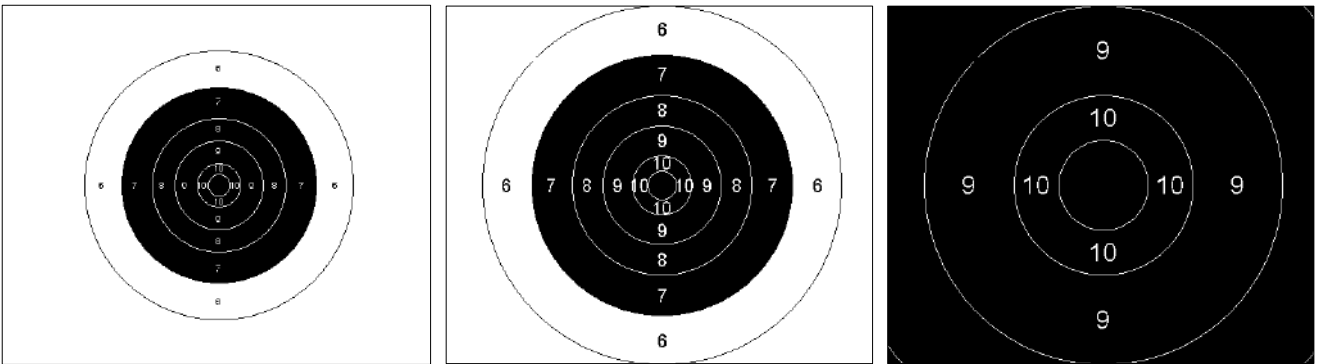

Technical data

Part No	735-0097-97-0234
Size	18 kb
Gauge (default)	7,62 mm
Aiming mark diameter	1117,6 mm
Manufacture	
Manufacture Part No	

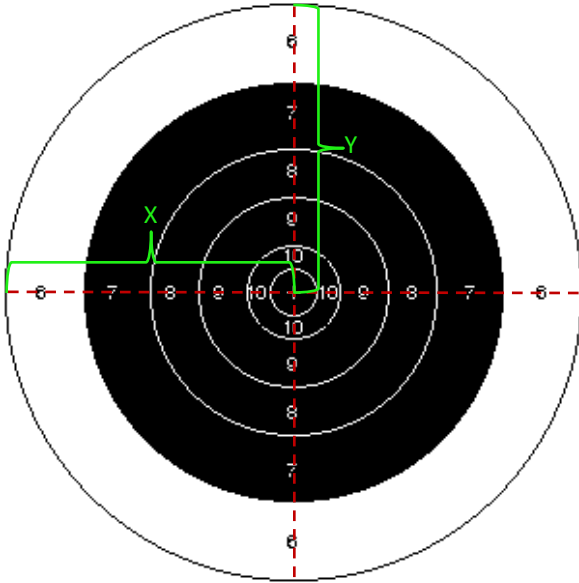

Diameter (mm)	Value
127	X
254	10
508	9
762	8
1117,6	7
1524	6
ROT	5

X	762 mm
Y	762 mm

Zoom levels

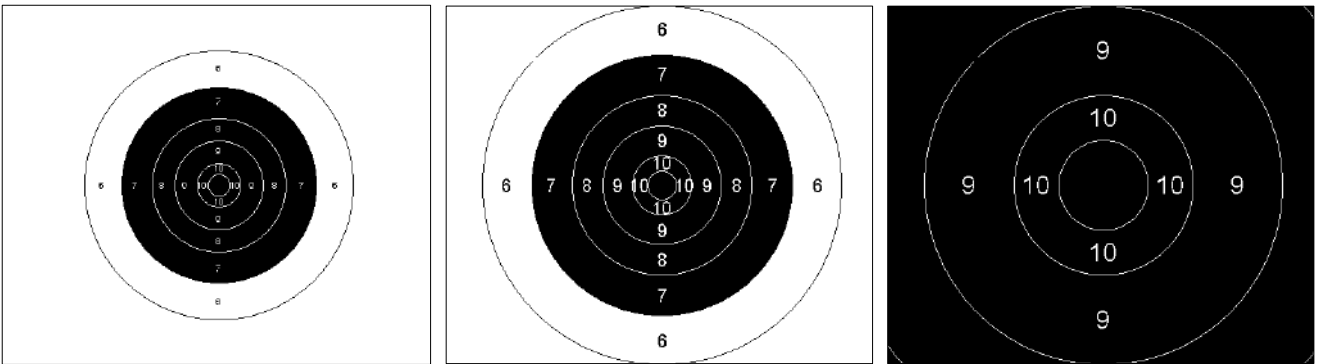

Technical data

Part No	735-0097-97-0235
Size	18 kb
Gauge (default)	7,62 mm
Aiming mark diameter	1117,6 mm
Manufacture	
Manufacture Part No	

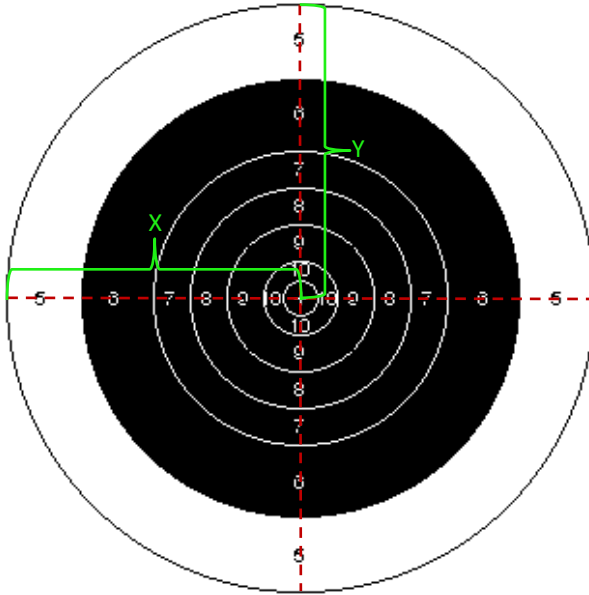

Diameter (mm)	Value
76,2	X
152,4	10
304,8	9
457,2	8
609,6	7
914,4	6
1219,2	5

X	609,6 mm
Y	609,6 mm

Zoom levels

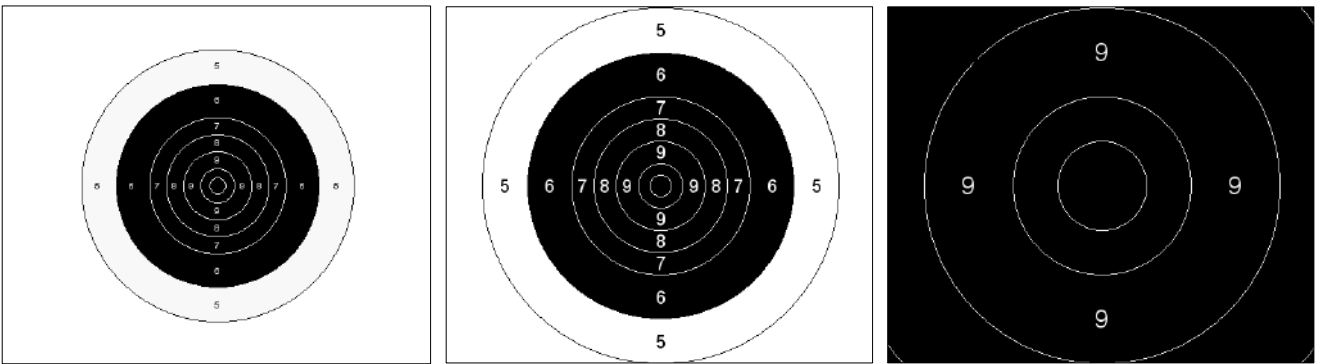

Technical data

Part No	735-0097-97-0240
Size	2 kb
Gauge (default)	7,62 mm
Aiming mark diameter	914,4 mm
Manufacture	
Manufacture Part No	

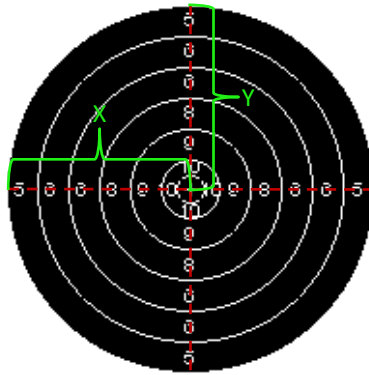

Diameter (mm)	Value
63,5	X
127	10
254	9
381	8
508	7
635	6
762	5

X	381 mm
Y	381 mm

Zoom levels

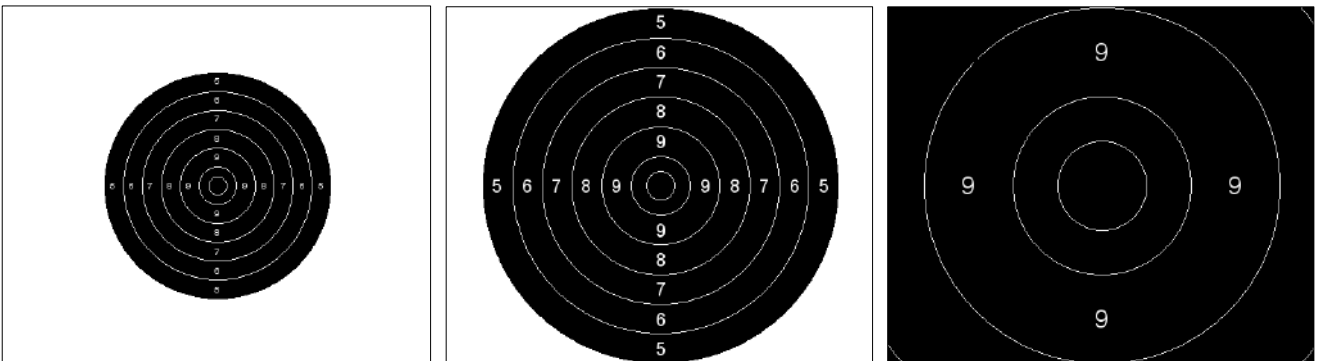

Technical data

Part No	735-0097-97-0241
Size	2 kb
Gauge (default)	7,62 mm
Aiming mark diameter	762 mm
Manufacture	
Manufacture Part No	

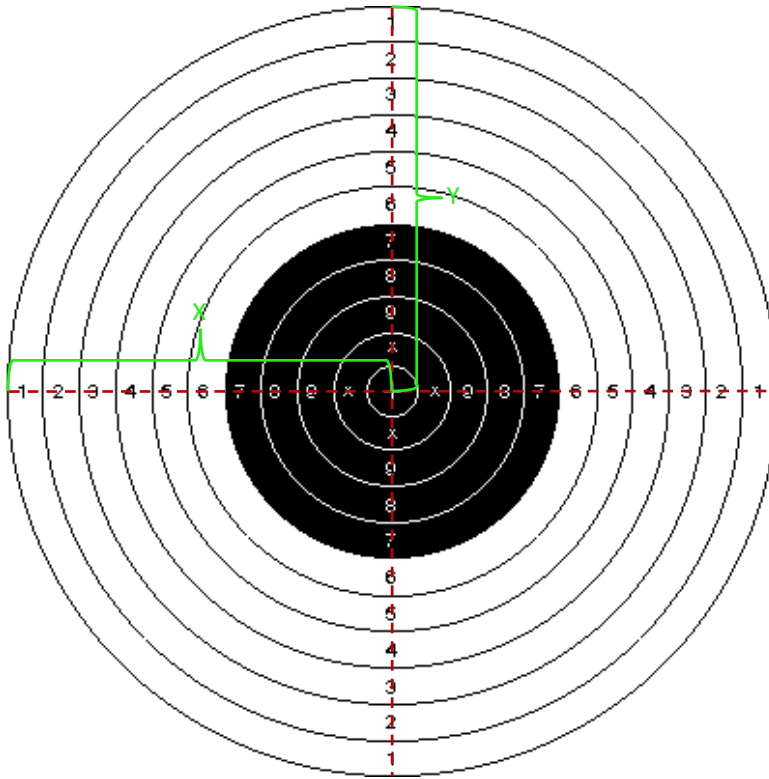

Diameter (mm)	Value
11,2	*
26,4	X
42,4	9
58,4	8
74,4	7
90,4	6
106,4	5
122,4	4
138,4	3
154,4	2
170,4	1

X	85,2 mm
Y	85,2 mm

Zoom levels

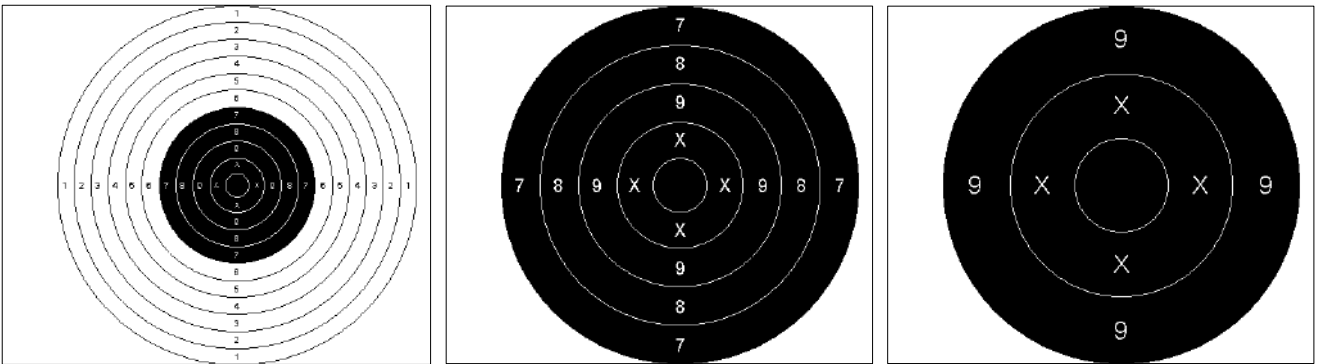

Technical data

Part No	735-0097-97-0242
Size	N/A
Gauge (default)	5,6 mm
Aiming mark diameter	74,4 mm
Manufacture	
Manufacture Part No	

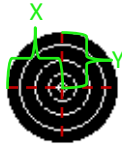

Diameter (mm)	Value
2	*
6,35	X
12,7	9
19,05	8
25,4	7

X	12,7 mm
Y	12,7 mm

Zoom levels

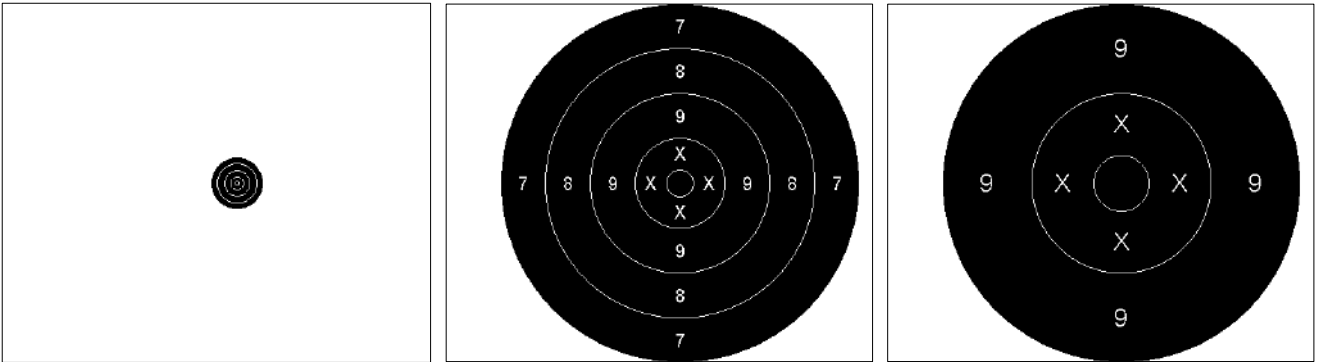

Technical data

Part No	735-0097-97-0243
Size	N/A
Gauge (default)	5,6 mm
Aiming mark diameter	25,4 mm
Manufacture	
Manufacture Part No	

Diameter (mm)	Value
20	X

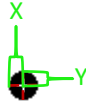

X	10 mm
Y	10 mm

Zoom levels

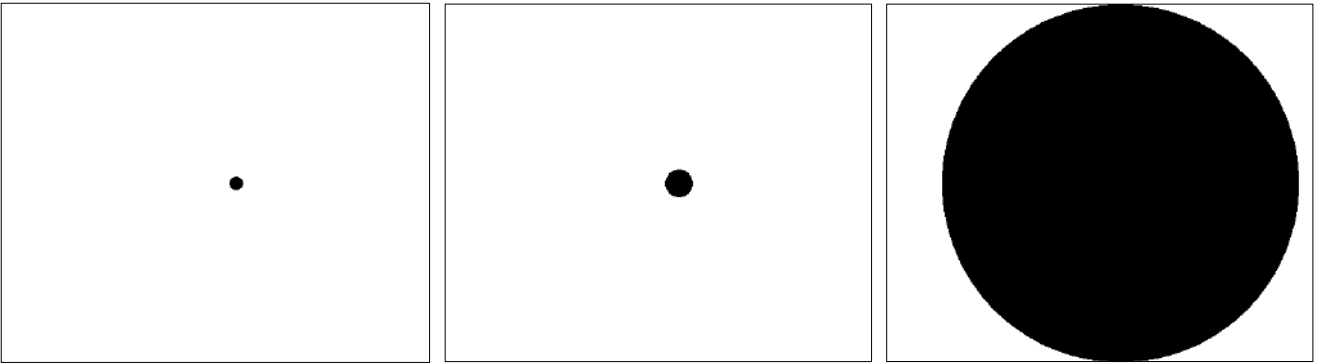

Technical data

Part No	735-0097-97-0244
Size	N/A
Gauge (default)	5,6 mm
Aiming mark diameter	20 mm
Manufacture	
Manufacture Part No	

Diameter (mm)	Value
40	X

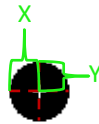

X	20 mm
Y	20 mm

Zoom levels

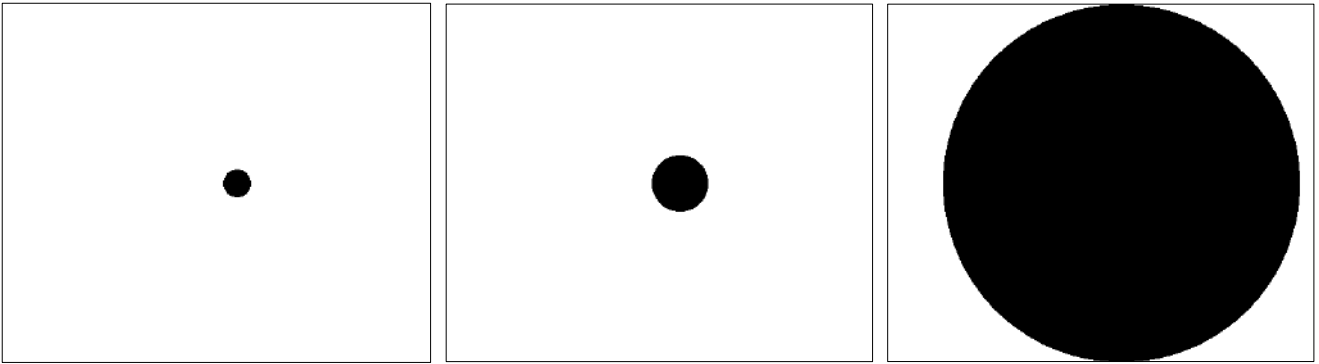

Technical data

Part No	735-0097-97-0245
Size	N/A
Gauge (default)	5,6 mm
Aiming mark diameter	40 mm
Manufacture	
Manufacture Part No	

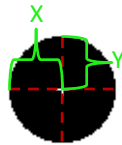

Diameter (mm)	Value
70	X

X	35 mm
Y	35 mm

Zoom levels

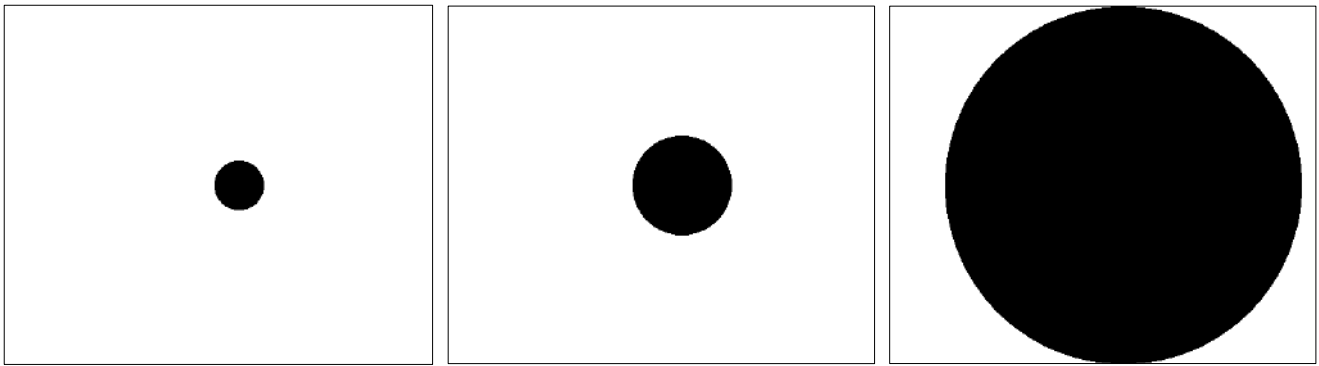

Technical data

Part No	735-0097-97-0246
Size	N/A
Gauge (default)	5,6 mm
Aiming mark diameter	70 mm
Manufacture	
Manufacture Part No	

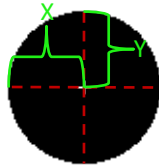

Diameter (mm)	Value
100	X

X	50 mm
Y	50 mm

Zoom levels

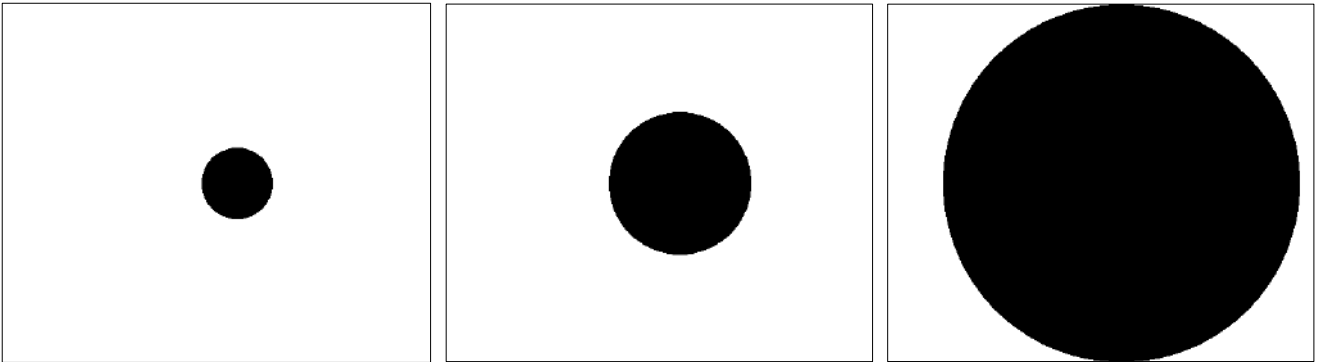

Technical data

Part No	735-0097-97-0247
Size	N/A
Gauge (default)	5,6 mm
Aiming mark diameter	100 mm
Manufacture	
Manufacture Part No	

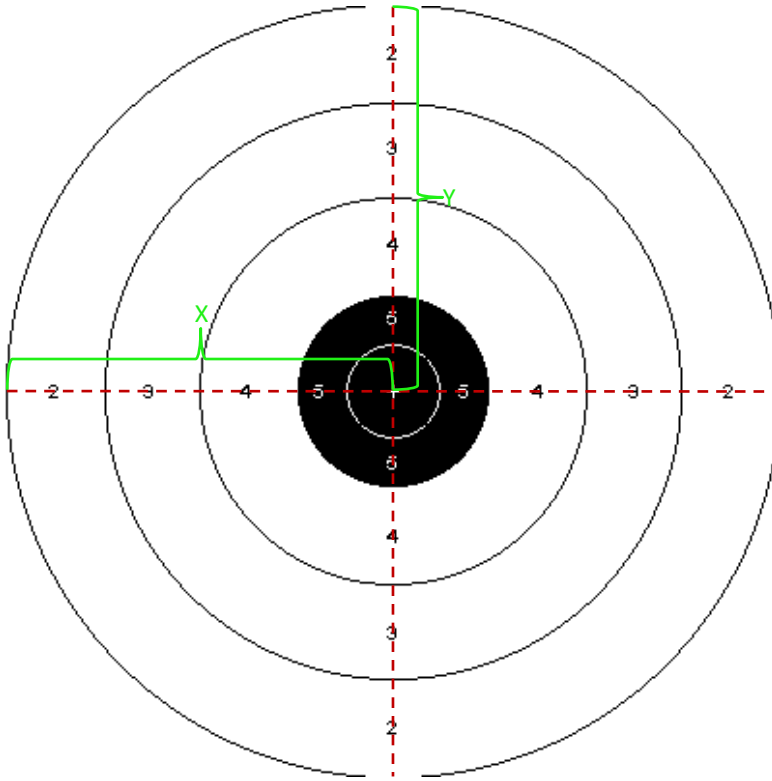

Diameter (mm)	Value
152	5
305	5
610	4
914	3
1219	2
ROT	1

X	609,5 mm
Y	609,5 mm

Zoom levels

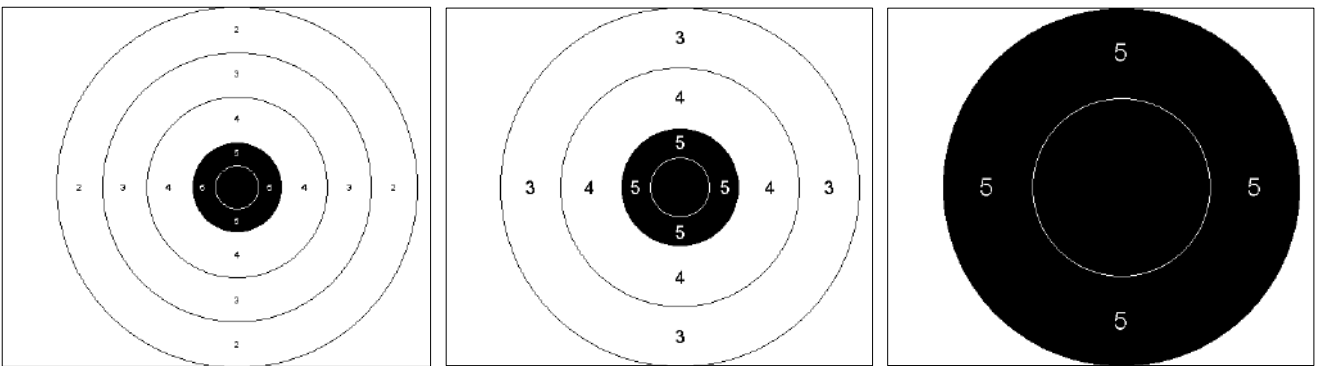

Technical data

Part No	735-0097-97-0248
Size	16 kb
Gauge (default)	7,62 mm
Aiming mark diameter	305 mm
Manufacture	
Manufacture Part No	

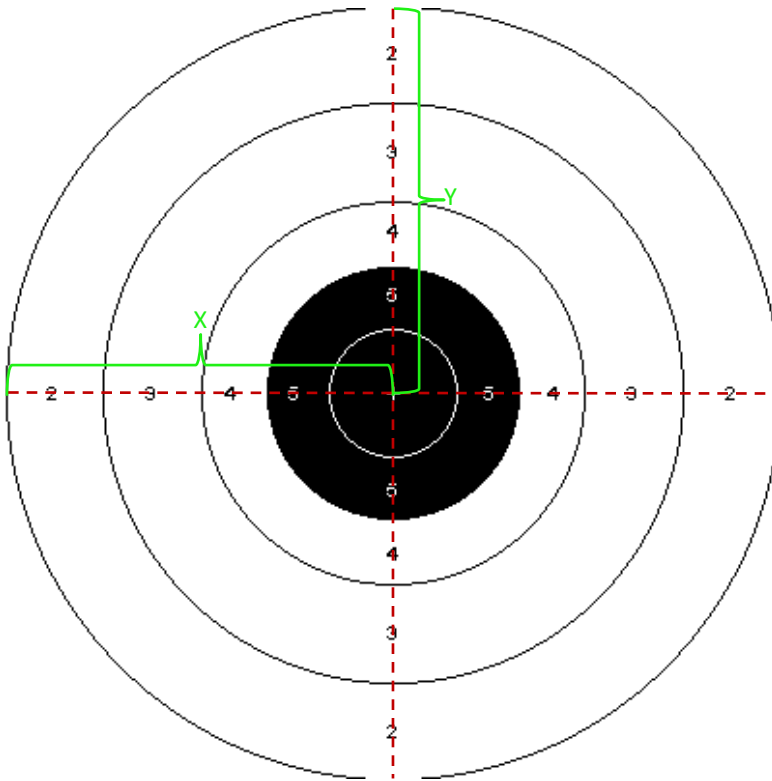

Diameter (mm)	Value
305	5
610	5
914	4
1372	3
1829	2
ROT	1

X	914,5 mm
Y	914.5 mm

Zoom levels

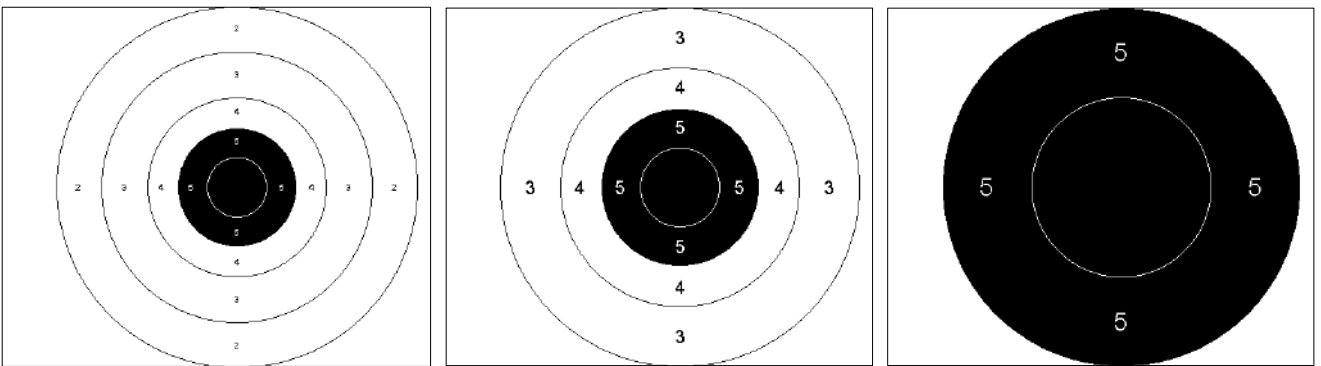

Technical data

Part No	735-0097-97-0249
Size	16 kb
Gauge (default)	7,62 mm
Aiming mark diameter	610 mm
Manufacture	
Manufacture Part No	

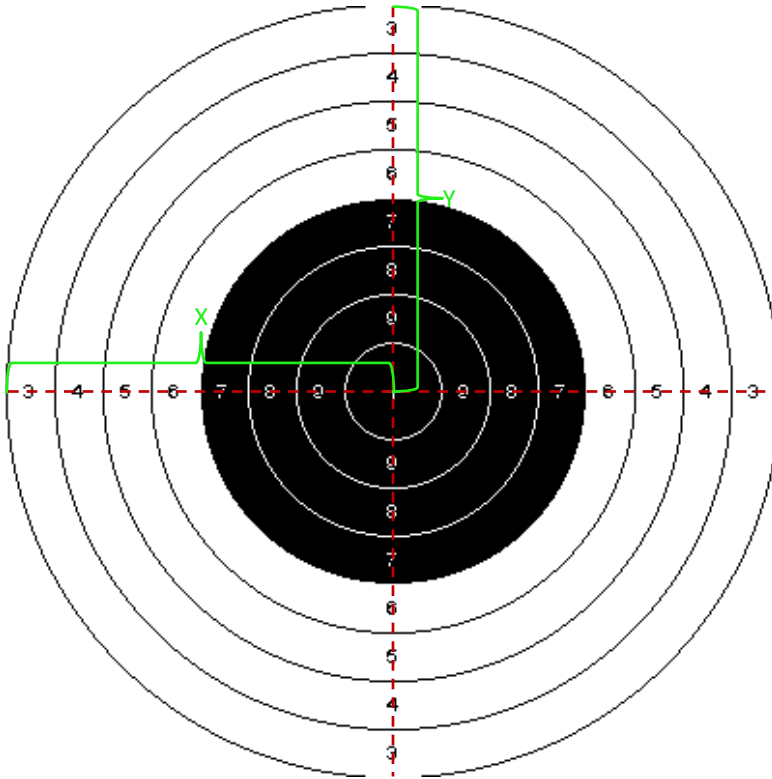

Diameter (mm)	Value
25	X
50	9
75	8
100	7
125	6
150	5
175	4
200	3

X	100 mm
Y	100 mm

Zoom levels

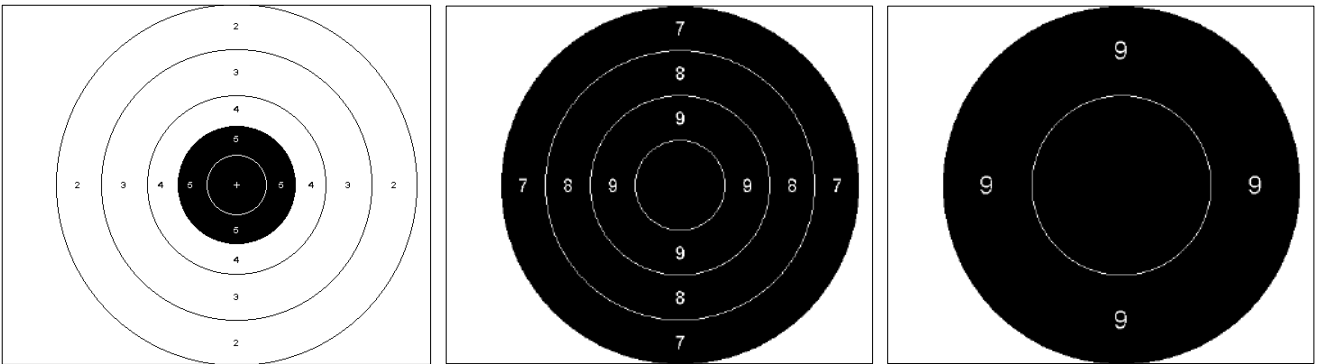

Technical data

Part No	735-0097-97-0250
Size	N/A
Gauge (default)	5,6 mm
Aiming mark diameter	100 mm
Manufacture	
Manufacture Part No	

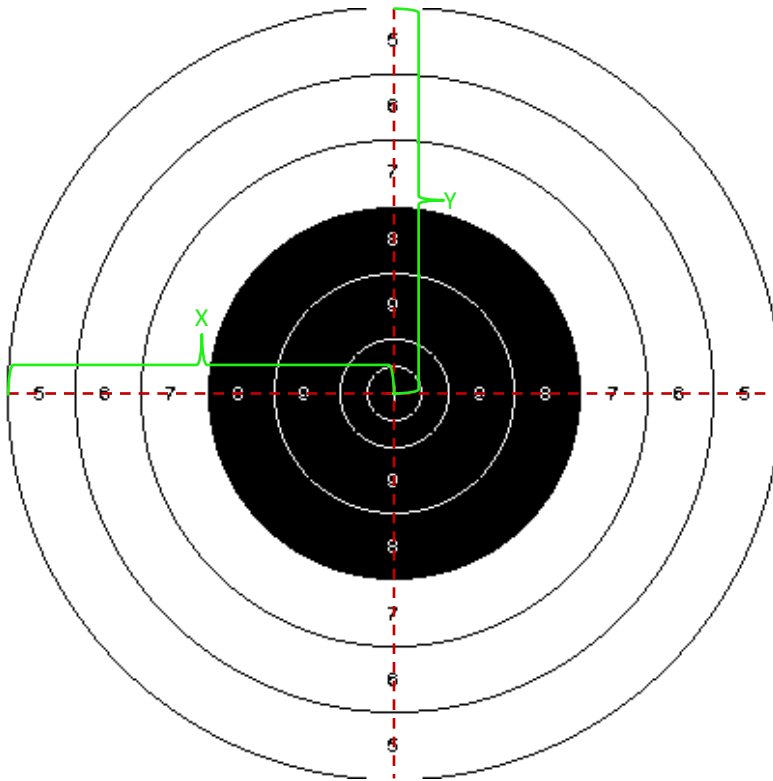

Diameter (mm)	Value
11,05	*
22,1	X
48,7	9
75,3	8
101,9	7
128,5	6
155,1	5

X	77,55 mm
Y	77,50 mm

Zoom levels

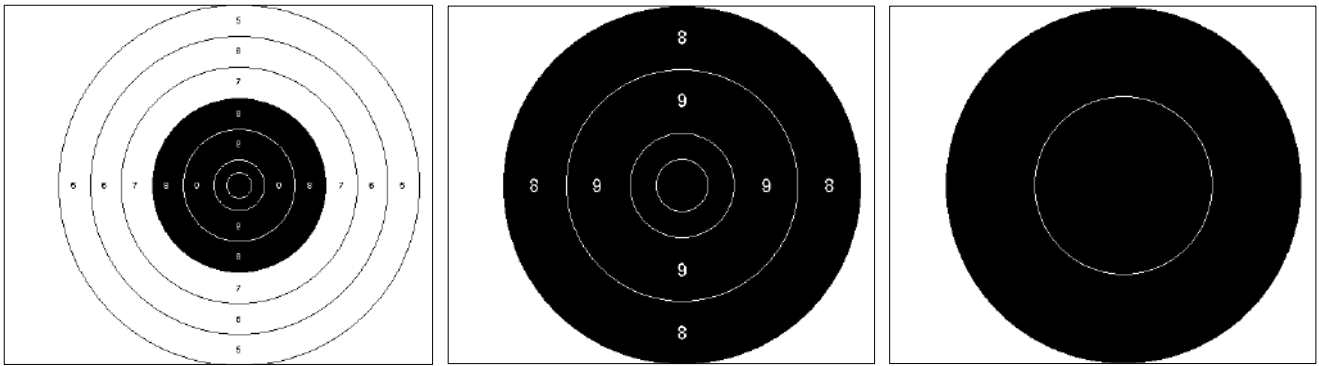

Technical data

Part No	735-0097-97-0251
Size	N/A
Gauge (default)	4,5 mm
Aiming mark diameter	75,3 mm
Manufacture	
Manufacture Part No	

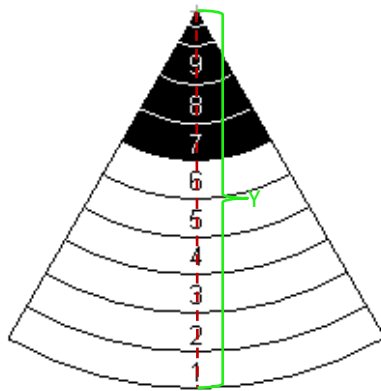

Diameter (mm)	Value
30	*
60	X
120	9
180	8
240	7
300	6
360	5
420	4
480	3
540	2
600	1

X	
Y	300 mm

Zoom levels

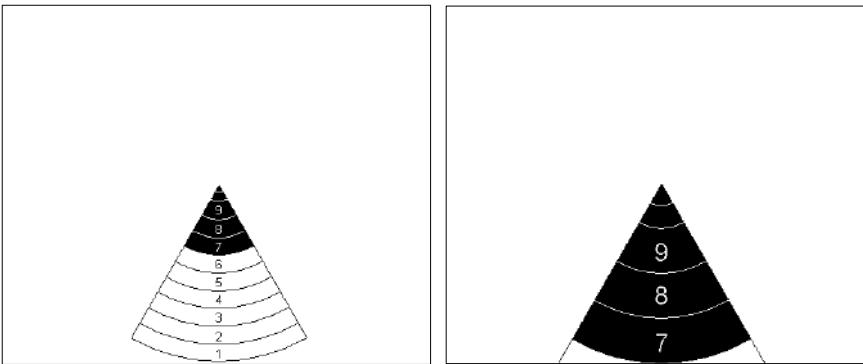

Technical data

Part No	735-0097-97-0252
Size	45 kb
Gauge (default)	8 mm
Aiming mark diameter	240 mm
Manufacture	
Manufacture Part No	

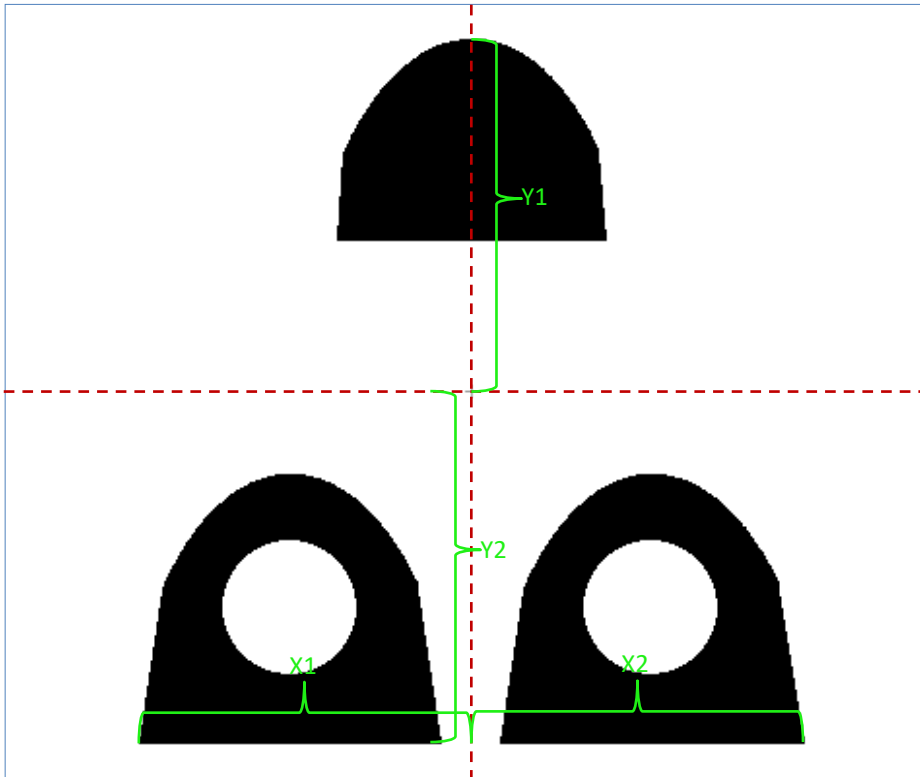

Diameter (mm)	Value

X1	495 mm	X2	460 mm
Y1	525 mm	Y2	525 mm

Zoom levels

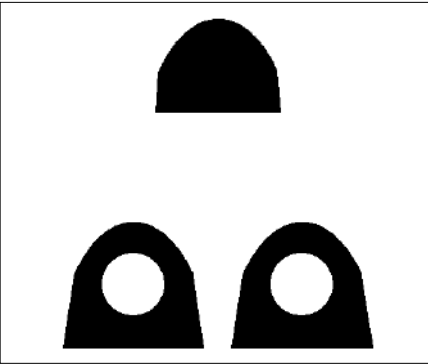

Technical data

Part No	735-0097-97-0253
Size	41 kb
Gauge (default)	5,56 mm
Aiming mark diameter	
Manufacture	BEO
Manufacture Part No	BEO-CIOR



Diameter (mm)	Value
800	3
1200	2

X1	436 mm
Y1	1126 mm

Zoom levels

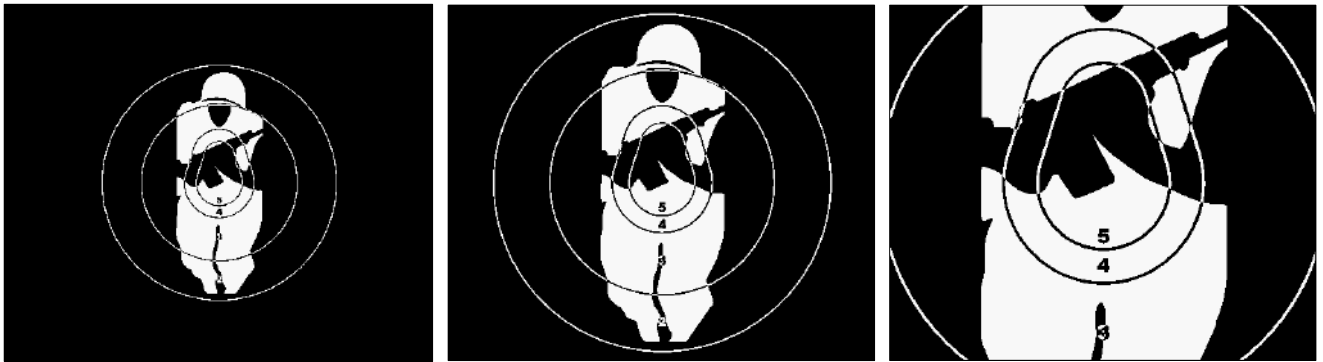

Technical data

Part No	735-0097-97-0255
Size	151 kb
Gauge (default)	7,62 mm
Aiming mark diameter	
Manufacture	Thermbright
Manufacture Part No	1 MJS 6040

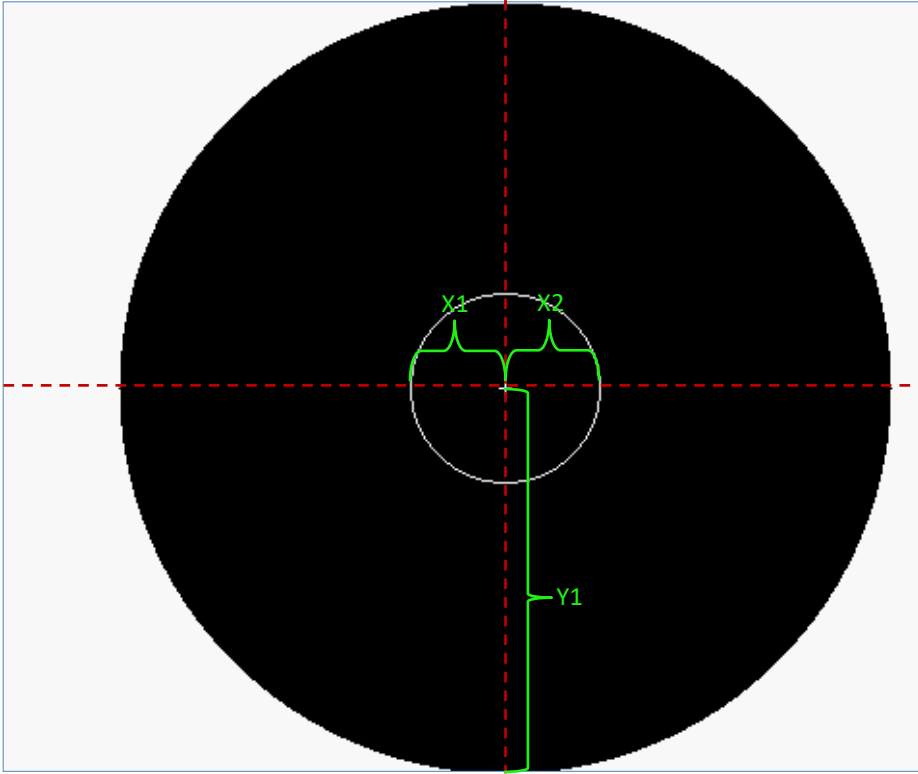

Diameter (mm)	Value
124	1

X1	62 mm	X2	62 mm
Y1	250 mm		

Zoom levels

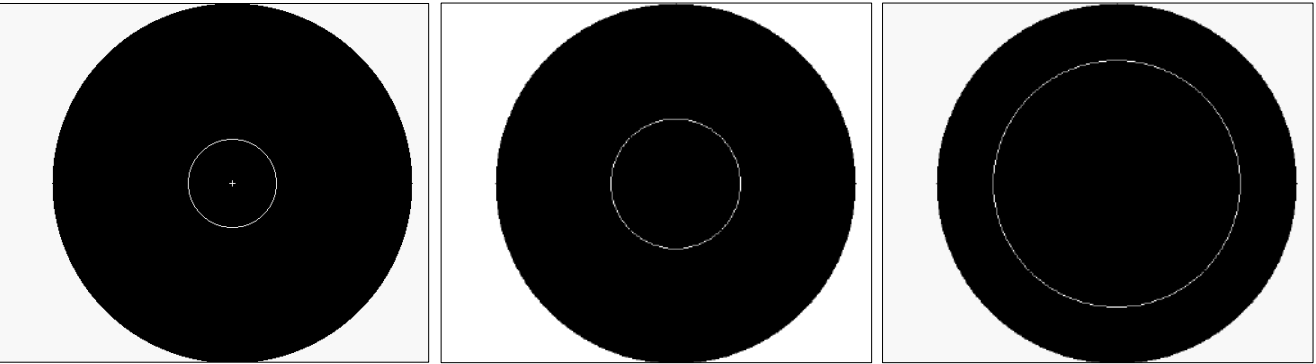

Technical data

Part No	735-0097-97-0257
Size	N/A
Gauge (default)	5,6 mm
Aiming mark diameter	250 mm
Manufacture	
Manufacture Part No	

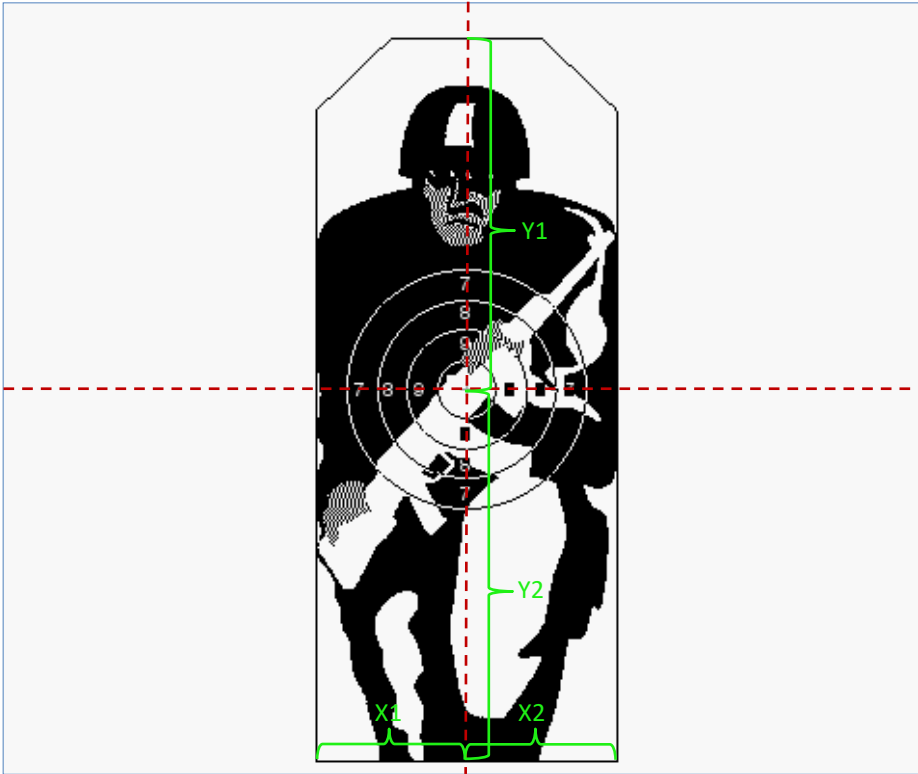

Diameter (mm)	Value
100	10
200	9
300	8
400	7
Hit Zone 1	6
Hit Zone 2	1

X1	250 mm	X2	250mm
Y1	580mm	Y2	620 mm

Zoom levels

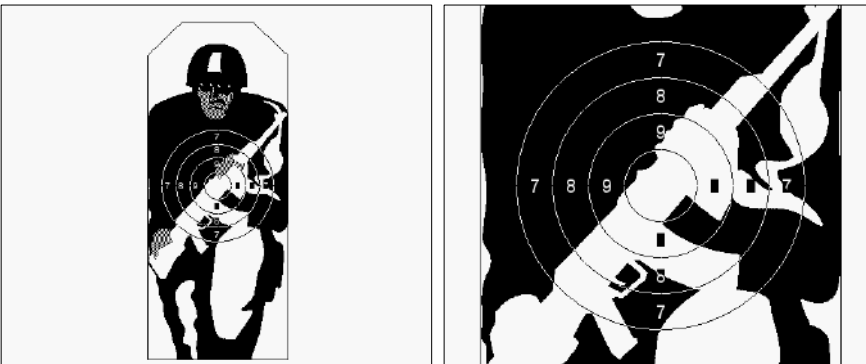

Technical data

Part No	735-0097-97-0258
Size	83,4 kb
Gauge (default)	7,62 mm
Aiming mark diameter	
Manufacture	
Manufacture Part No	

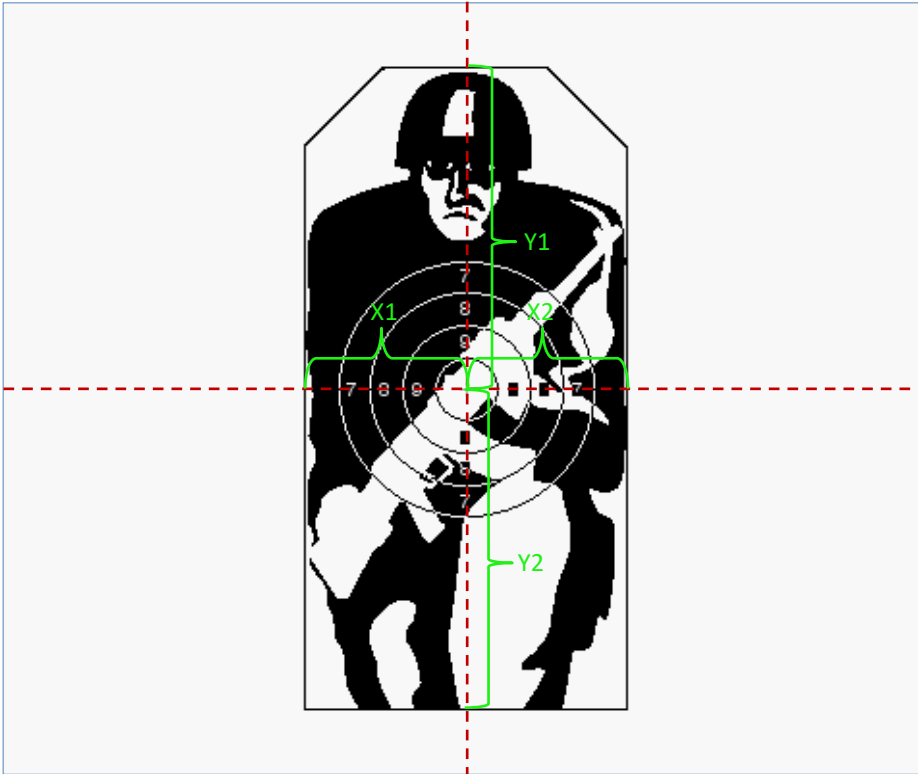

Diameter (mm)	Value
100	10
200	9
300	8
400	7
Hit Zone 1	6
Hit Zone 2	1

X1	250 mm	X2	250 mm
Y1	500 mm	Y2	500 mm

Zoom levels

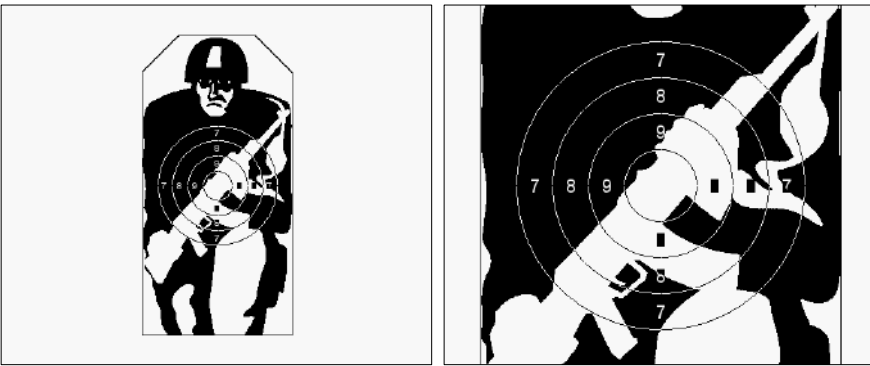

Technical data

Part No	735-0097-97-0259
Size	88,6 kb
Gauge (default)	7,62 mm
Aiming mark diameter	
Manufacture	
Manufacture Part No	

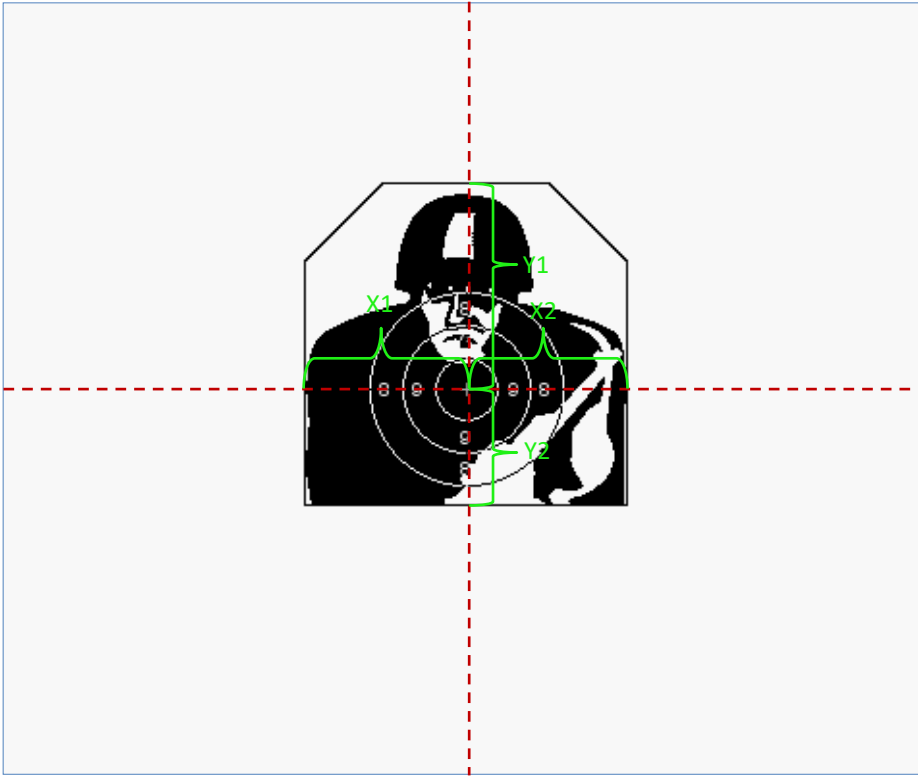

Diameter (mm)	Value
100	10
200	9
300	8
Hit Zone 1	7
Hit Zone 2	1

X1	250 mm	X2	250 mm
Y1	320 mm	Y2	180 mm

Zoom levels

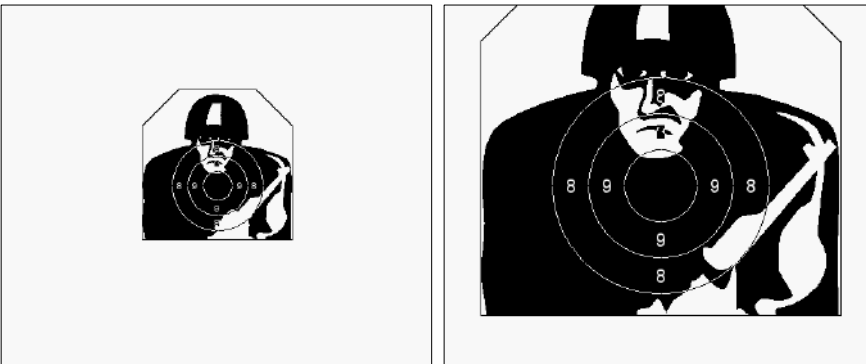

Technical data

Part No	735-0097-97-0260
Size	59,7 kb
Gauge (default)	7,62 mm
Aiming mark diameter	
Manufacture	
Manufacture Part No	

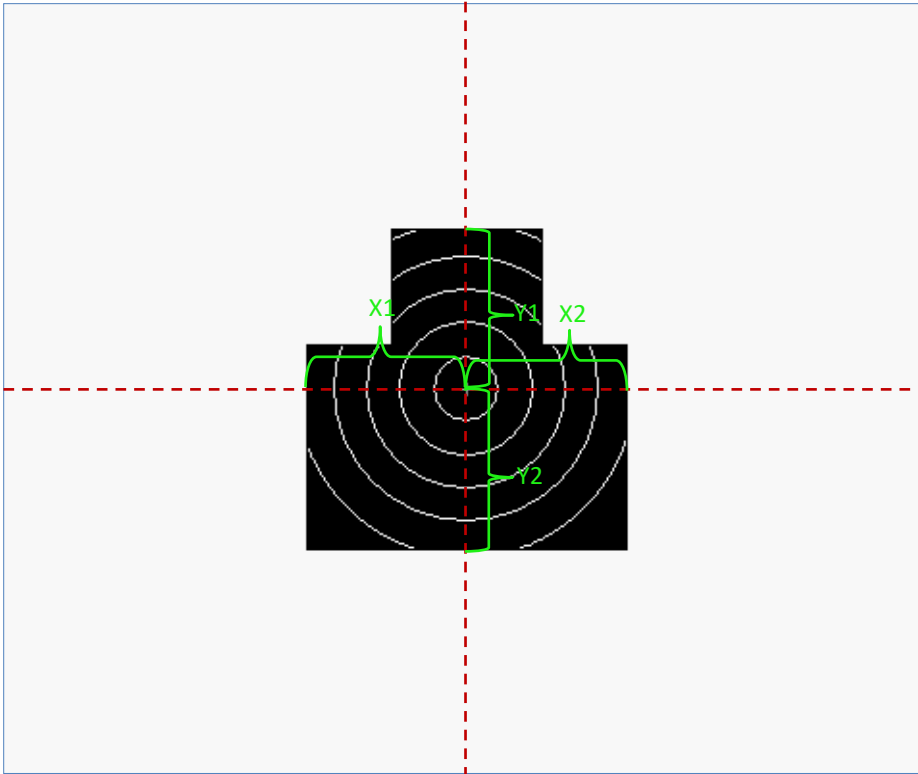

Diameter (mm)	Value
104	10
208	9
312	8
416	7
520	6
Hit Zone	5

X1	250 mm	X2	250 mm
Y1	250 mm	Y2	250 mm

Zoom levels

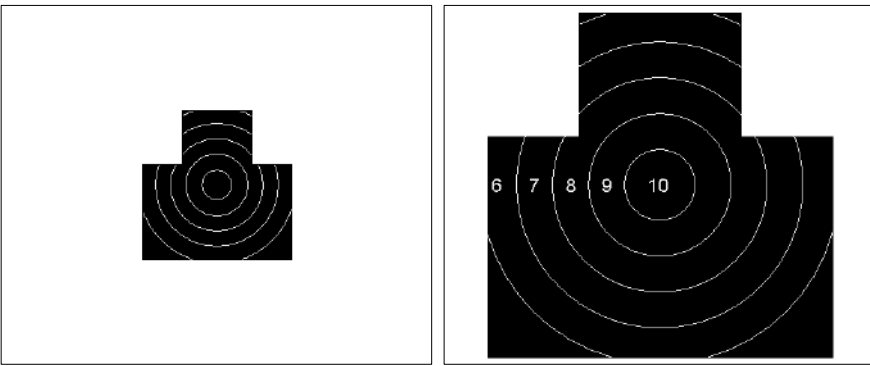

Technical data

Part No	735-0097-97-0261
Size	119 kb
Gauge (default)	7,62 mm
Aiming mark diameter	
Manufacture	
Manufacture Part No	

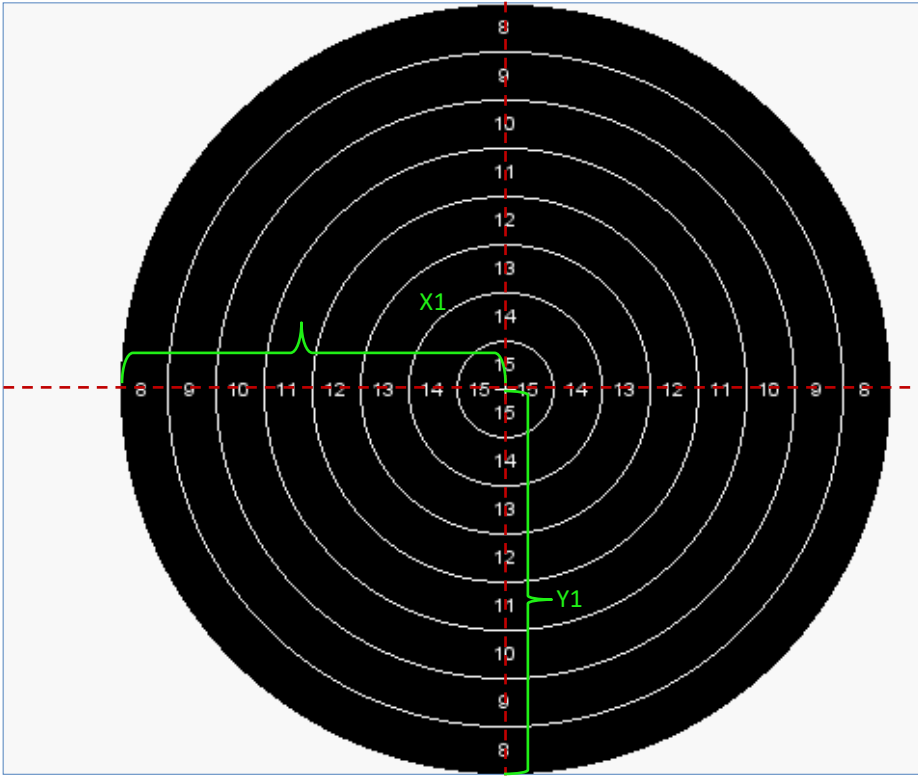

Diameter (mm)	Value
16	15
32	14
48	13
64	12
80	11
96	10
112	9
128	8
ROT	7

X1	64 mm
Y1	64 mm

Zoom levels

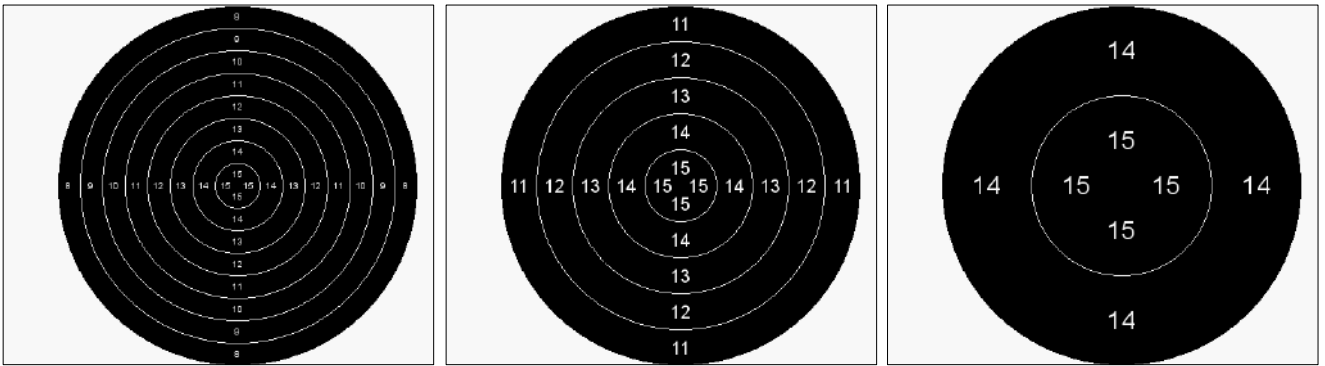

Technical data

Part No	735-0097-97-0262
Size	14 kb
Gauge (default)	7,62 mm
Aiming mark diameter	
Manufacture	
Manufacture Part No	

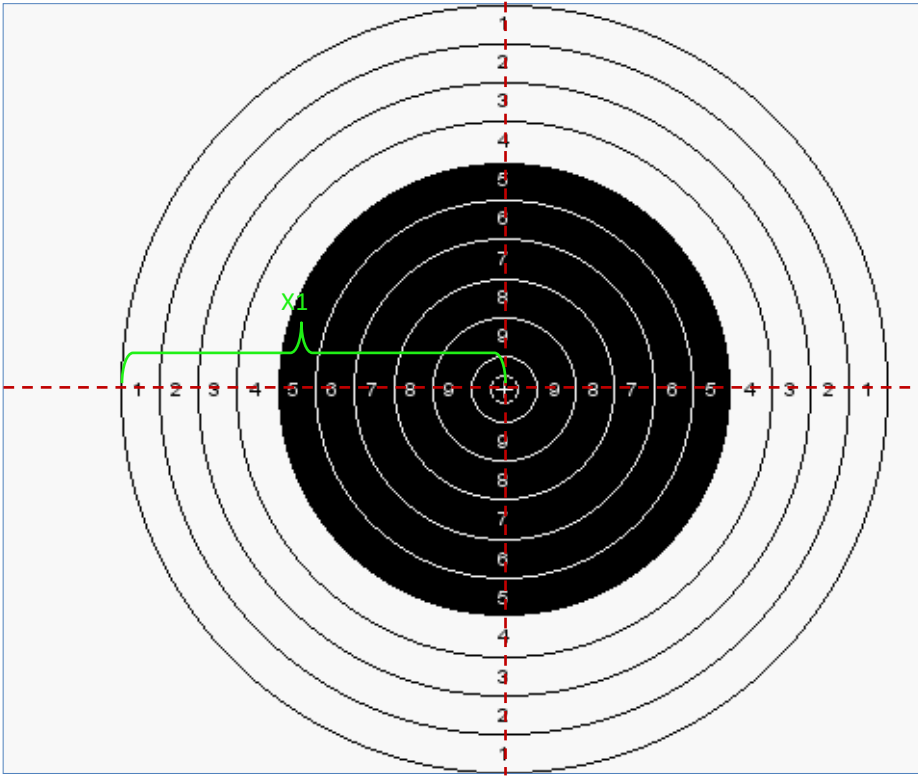

Diameter (mm)	Value
11,59	*
28,25	X
61,59	9
94,92	8
128,25	7
161,59	6
194,92	5
228,25	4
261,59	3
294,92	2
328,25	1

X1	164,125 mm

Zoom levels

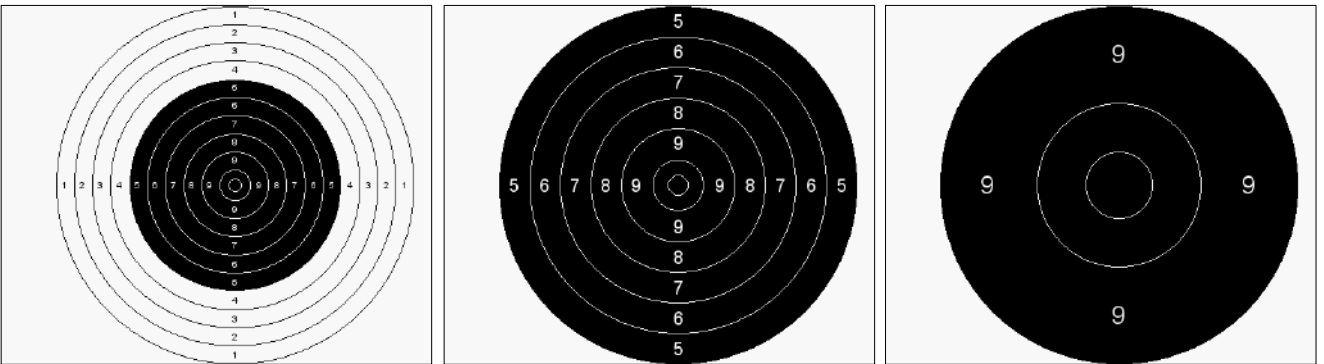

Technical data

Part No	735-0097-97-0263
Size	N/A
Gauge (default)	8 mm
Aiming mark diameter	194,92 mm
Manufacture	
Manufacture Part No	

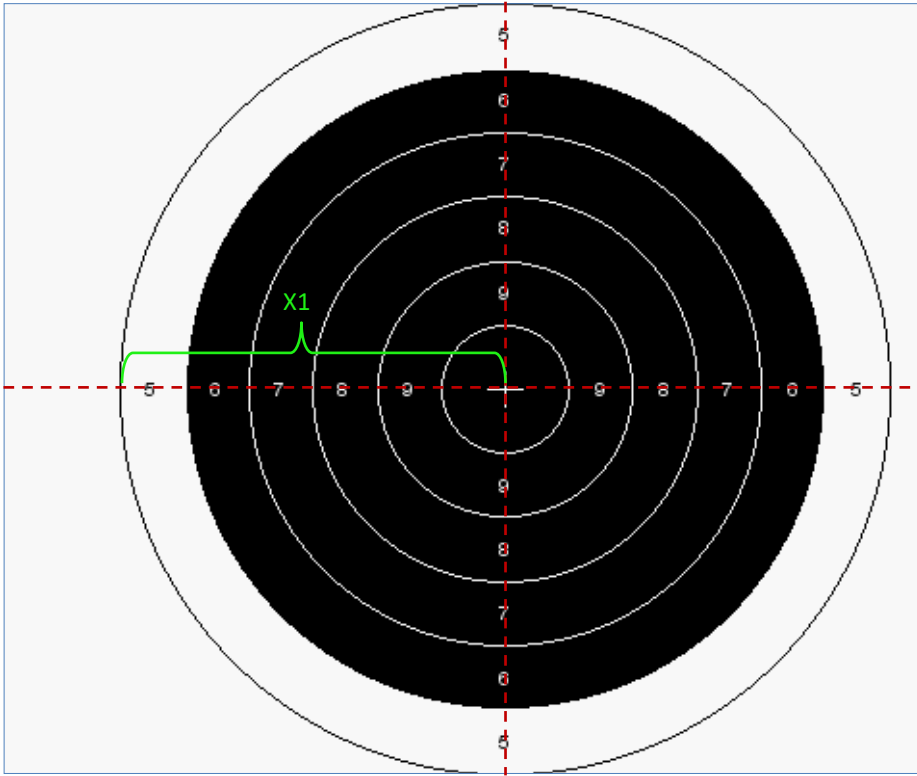

Diameter (mm)	Value
10	10
20	9
30	8
40	7
50	6
60	5

X1	30 mm

Zoom levels

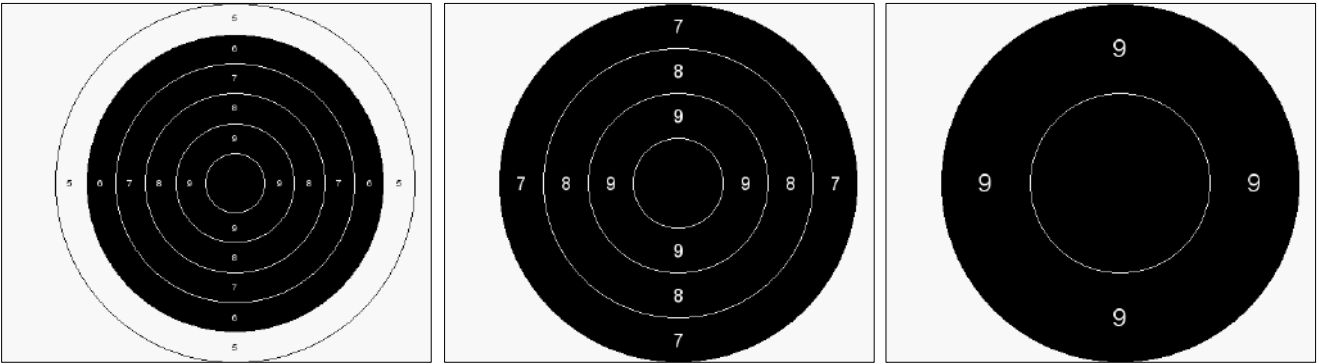

Technical data

Part No	735-0097-97-0264
Size	N/A
Gauge (default)	8 mm
Aiming mark diameter	50 mm
Manufacture	
Manufacture Part No	

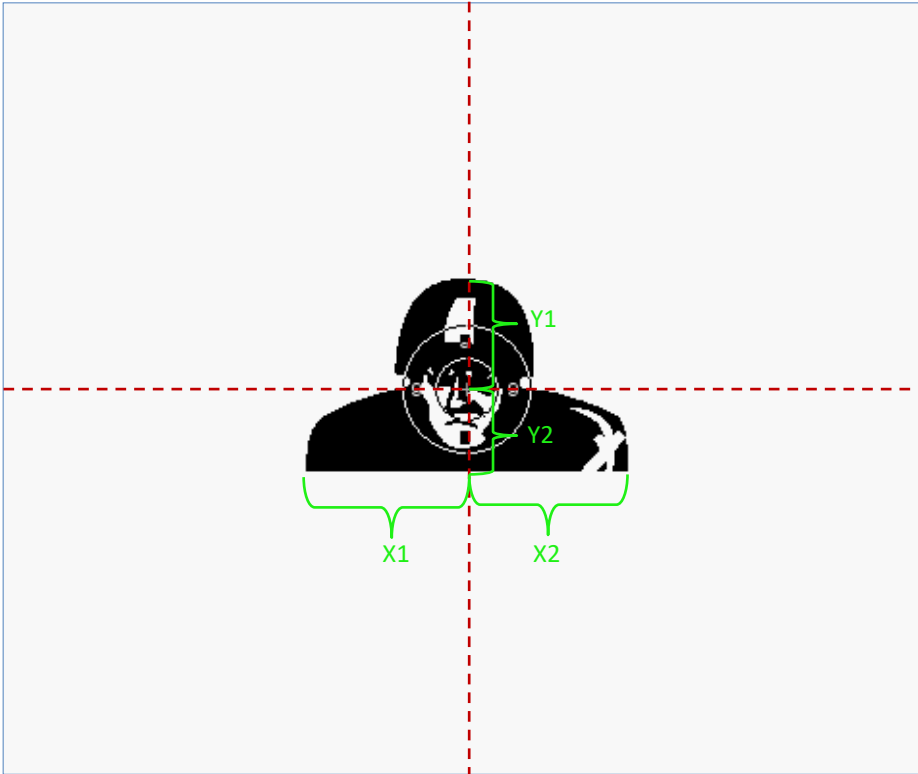

Diameter (mm)	Value
100	10
200	9
Hit Zone 1	8

X1	250 mm	X2	250 mm
Y1	170 mm	Y2	130 mm

Zoom levels

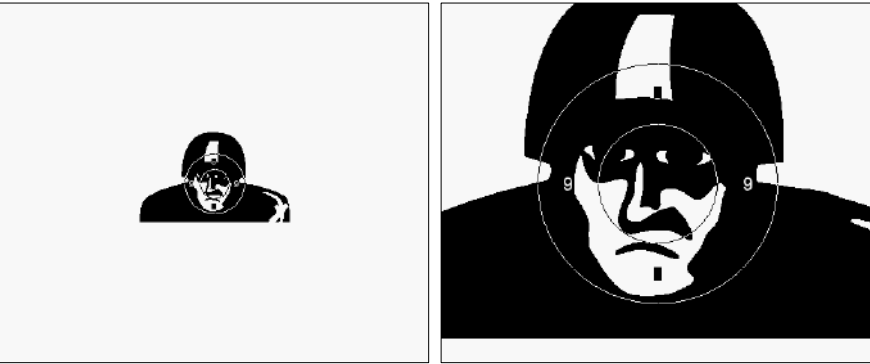

Technical data

Part No	735-0097-97-0265
Size	33,9 kb
Gauge (default)	7,62 mm
Aiming mark diameter	
Manufacture	
Manufacture Part No	

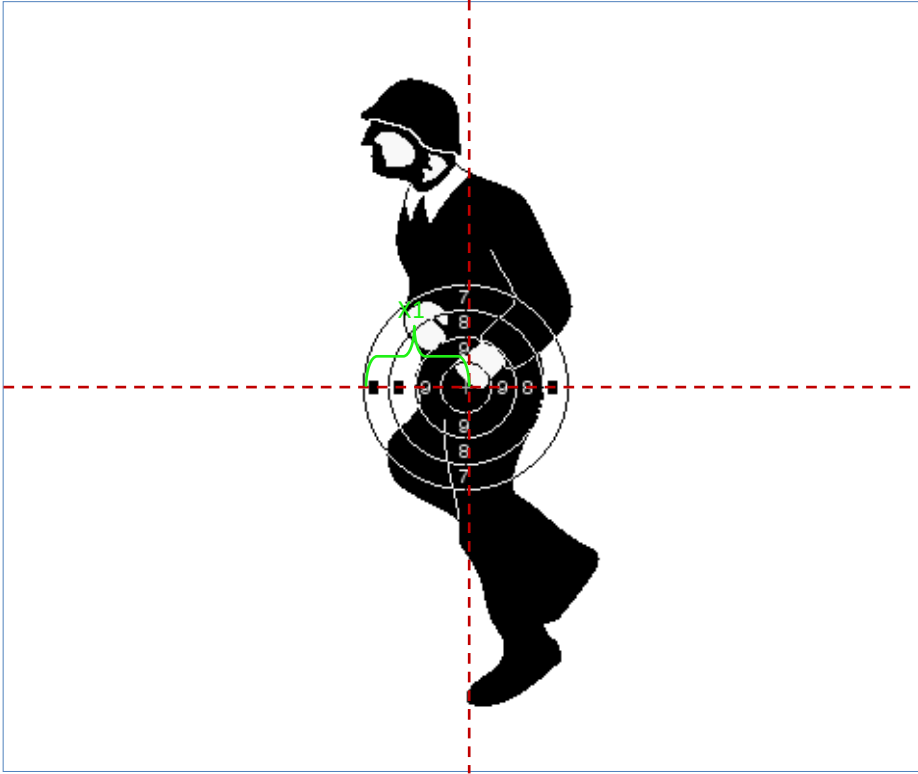

Diameter (mm)	Value
100	10
200	9
300	8
400	7
Hit Zone 1	6

X1	20 mm

Zoom levels

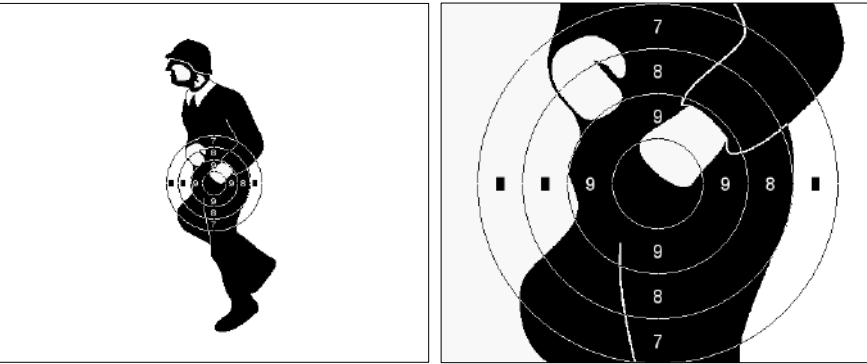

Technical data

Part No	735-0097-97-0266
Size	46,4 kb
Gauge (default)	7,62 mm
Aiming mark diameter	
Manufacture	
Manufacture Part No	

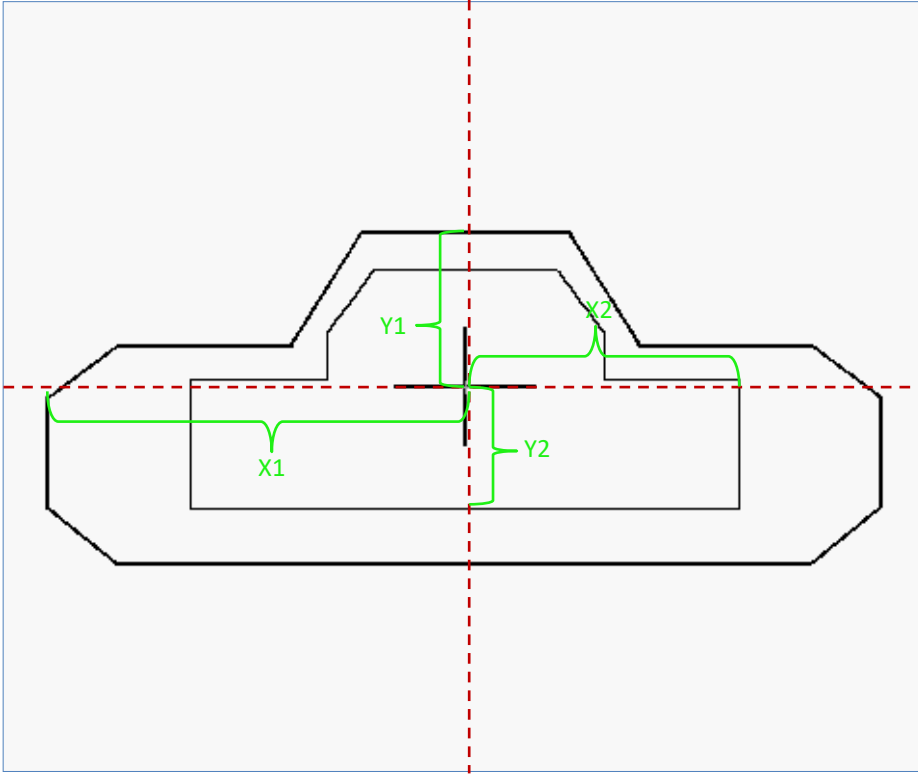

Diameter (mm)	Value
Hit Zone 1	10
Hit Zone 2	5

X1	650,2 mm	X2	426,8 mm
Y1	241,9 mm	Y2	189,3 mm

Zoom levels

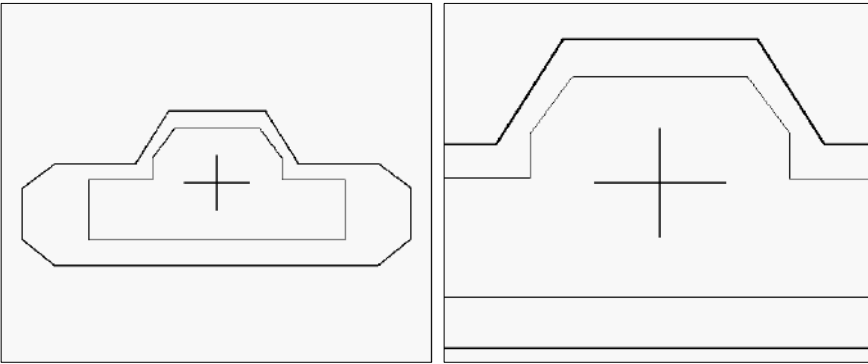

Technical data

Part No	735-0097-97-0267
Size	46,6 kb
Gauge (default)	7,62 mm
Aiming mark diameter	
Manufacture	
Manufacture Part No	

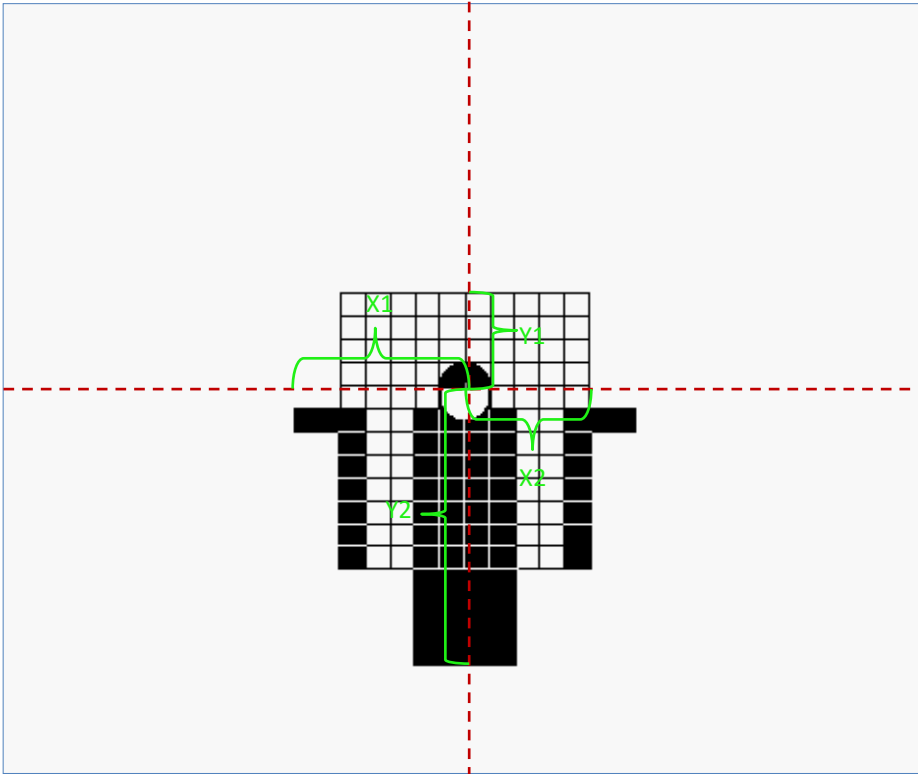

Diameter (mm)	Value
	0

X1	133 mm	X2	97,5 mm
Y1	74 mm	Y2	216,5 mm

Zoom levels

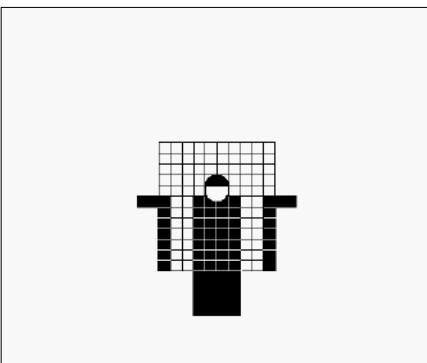

Technical data

Part No	735-0097-97-0268
Size	33,5 kb
Gauge (default)	7,62 mm
Aiming mark diameter	
Manufacture	
Manufacture Part No	

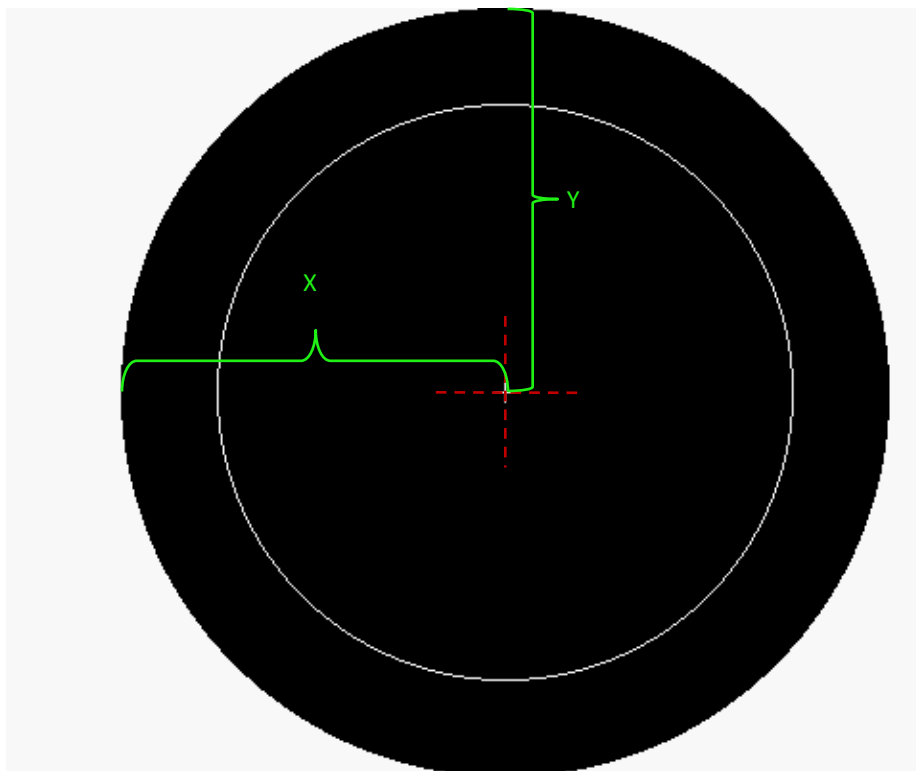

Diameter (mm)	Value
200	1
150	1

X	100 mm
Y	100 mm

Zoom levels

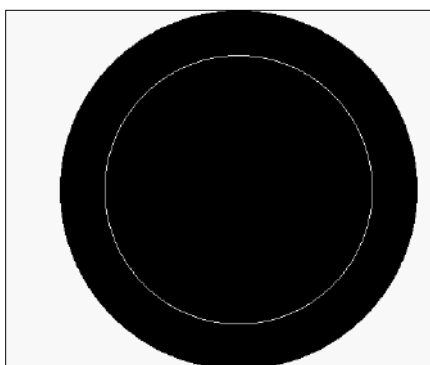

Technical data

Part No	735-0097-97-0269
Size	N/A
Gauge (default)	8 mm
Aiming mark diameter	200 mm
Manufacture	
Manufacture Part No	

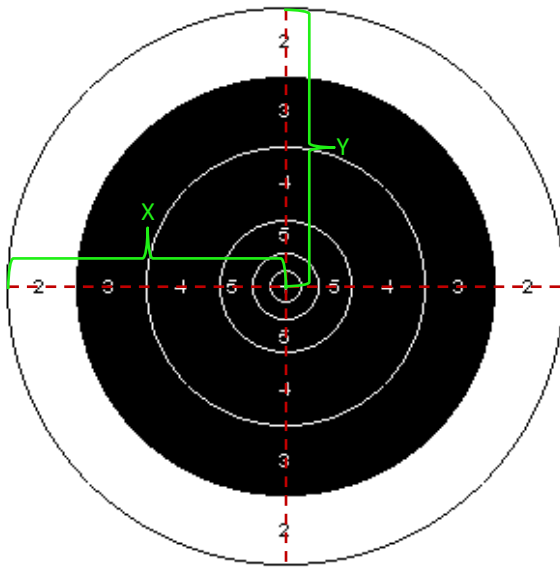

Diameter (mm)	Value
76	10.1
178	10
330	9
482	8
635	7
787	6
940	5
ROT	4

X	660 mm
Y	660 mm

Zoom levels

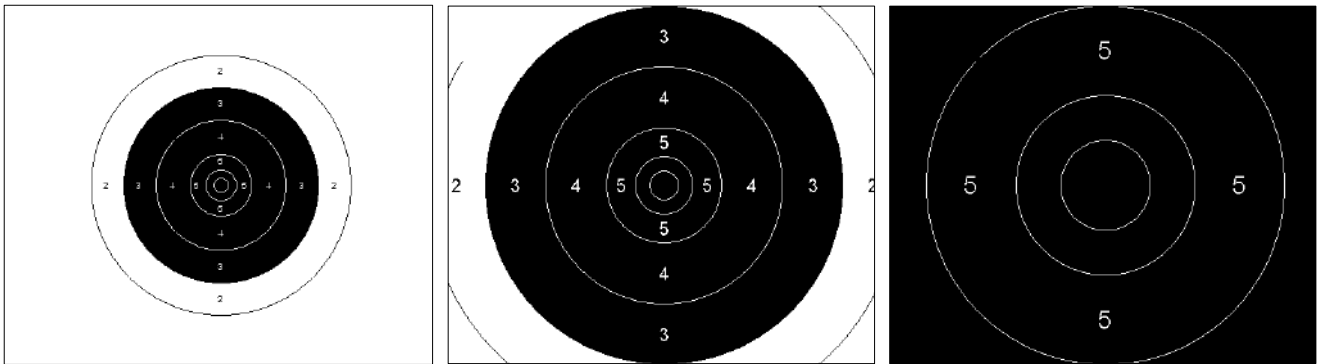

Technical data

Part No	735-0097-97-0270
Size	16 kB
Gauge (default)	7,82 mm
Aiming mark diameter	165 mm
Manufacture	
Manufacture Part No	

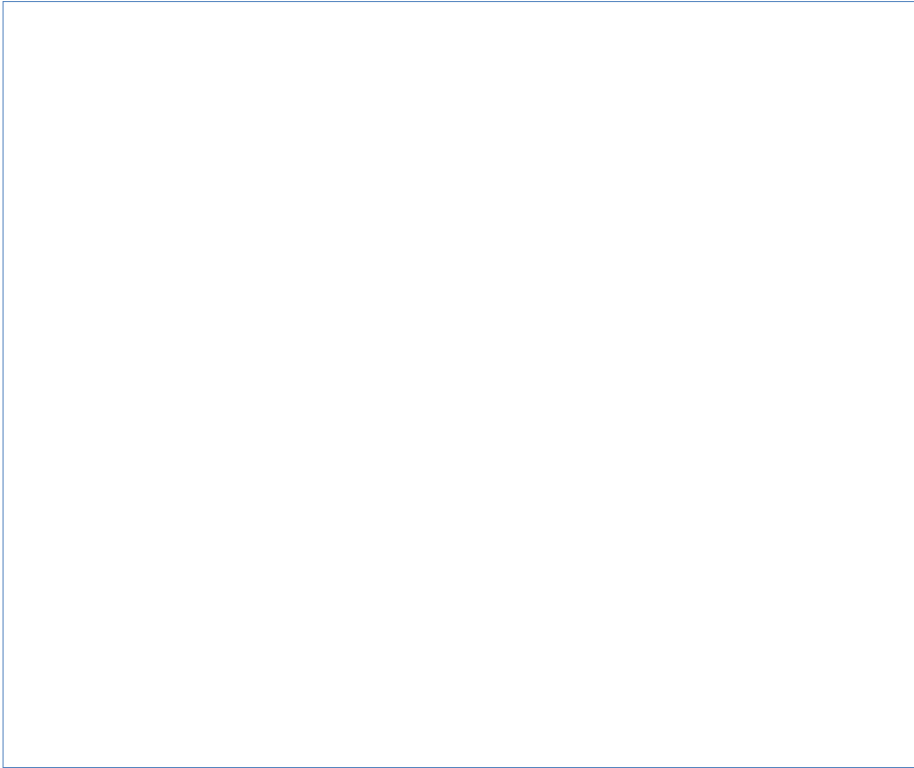

Diameter (mm)	Value
all	1

Zoom levels

--	--	--

Technical data

Part No	735-0097-97-0271
Size	16 kB
Gauge (default)	8 mm
Aiming mark diameter	
Manufacture	
Manufacture Part No	

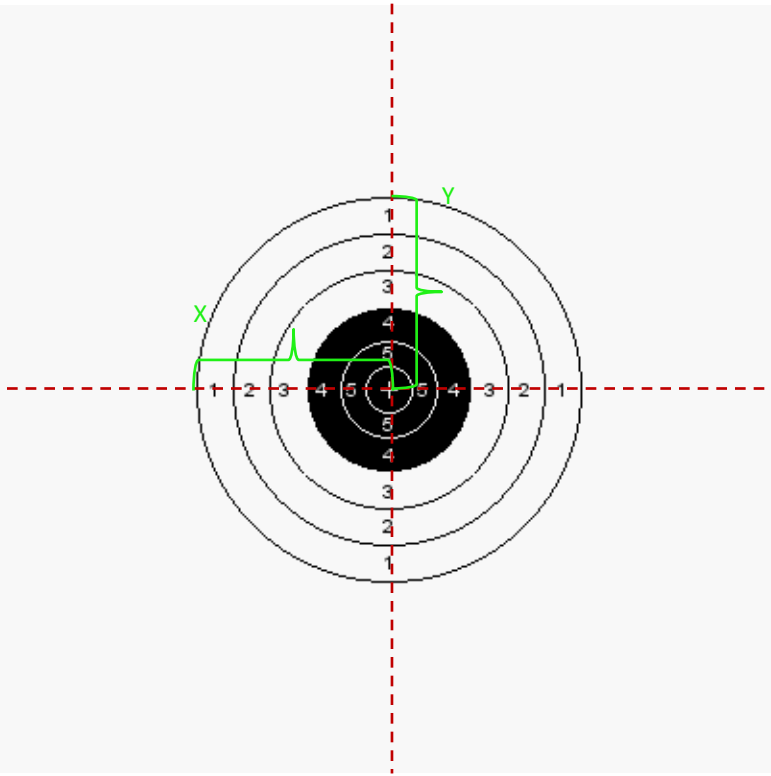

Diameter (mm)	Value
20	6
40	5
70	4
100	3
130	2
160	1

X	80 mm
Y	80 mm

Zoom levels

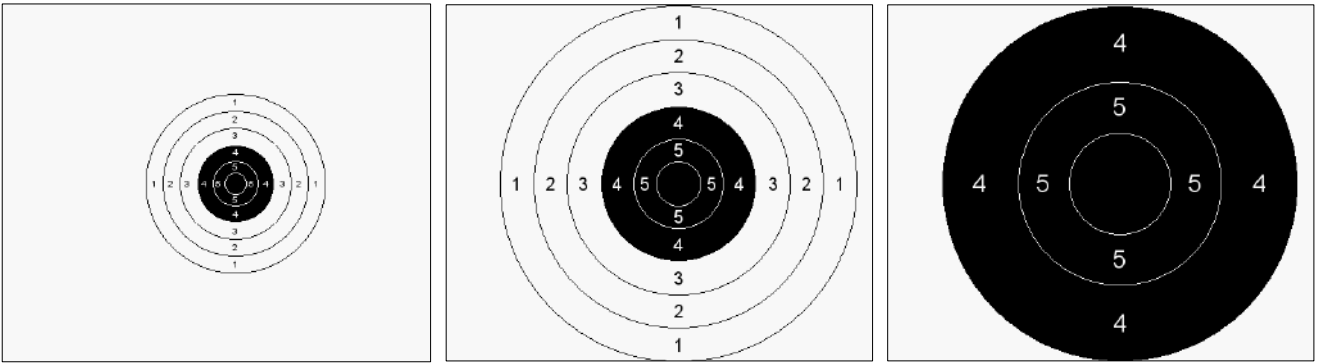

Technical data

Part No	735-0097-97-0274
Size	N/A
Gauge (default)	8 mm
Aiming mark diameter	70 mm
Manufacture	
Manufacture Part No	

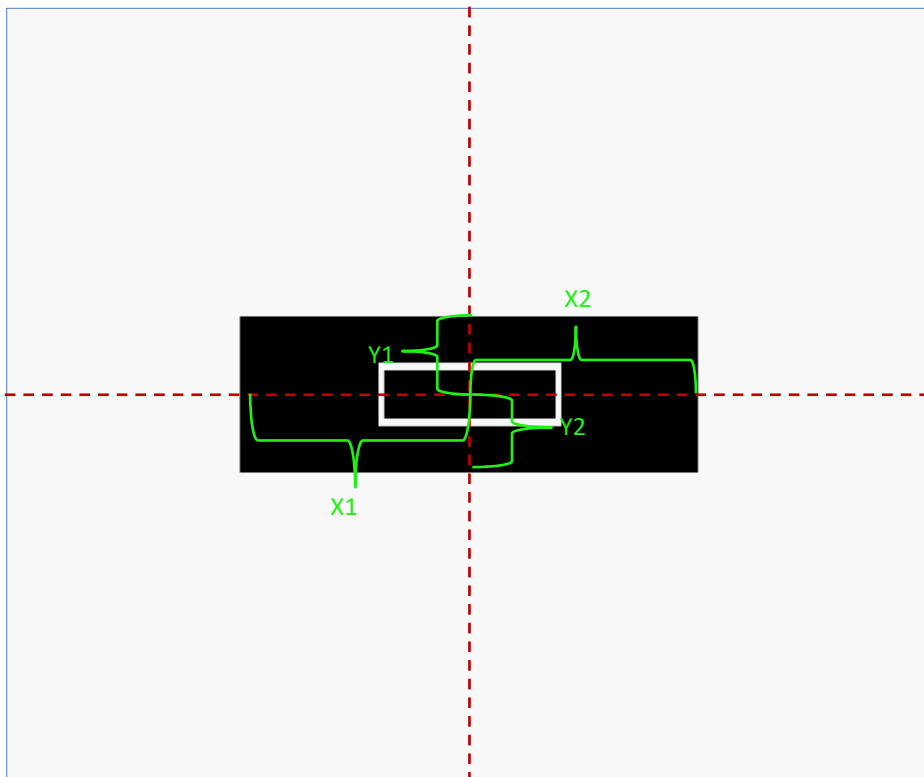

Diameter (mm)	Value

X1	150mm	X2	150 mm
Y1	50 mm	Y2	50 mm

Zoom levels

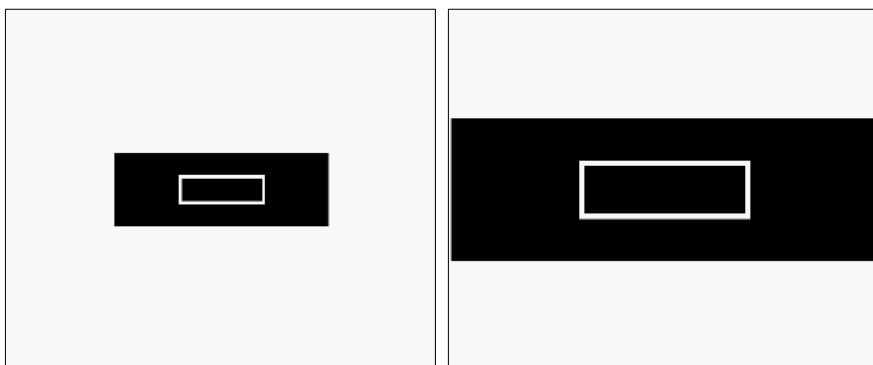

Technical data

Part No	735-0097-97-0277
Size	30 kb
Gauge (default)	8 mm
Aiming mark diameter	
Manufacture	
Manufacture Part No	

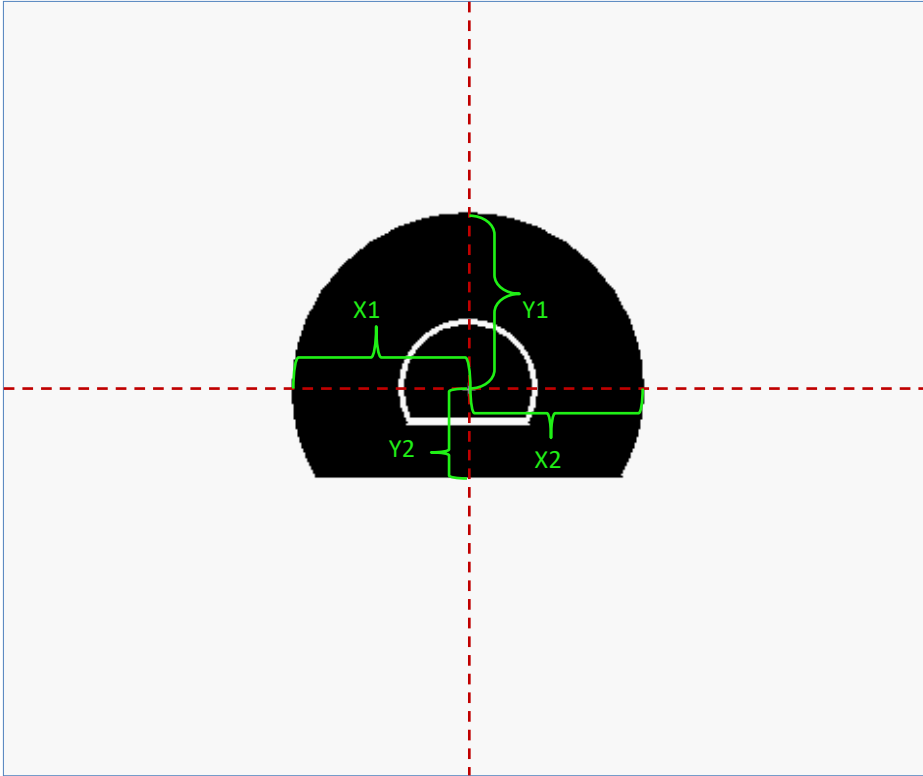

Diameter (mm)	Value

X1	100 mm	X2	100 mm
Y1	100 mm	Y2	49,94 mm

Zoom levels

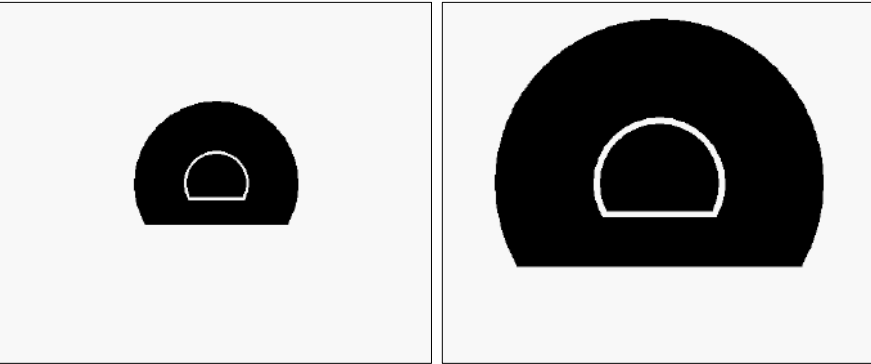

Technical data

Part No	735-0097-97-0278
Size	46 kB
Gauge (default)	8 mm
Aiming mark diameter	
Manufacture	
Manufacture Part No	

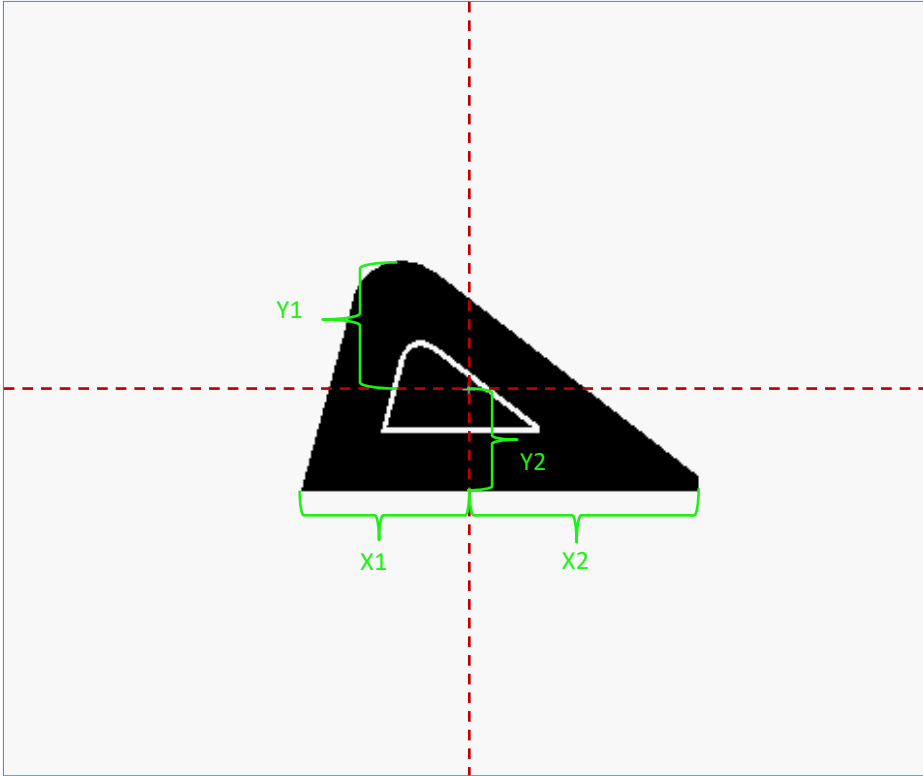

Diameter (mm)	Value

X1	190mm	X2	260 mm
Y1	145 mm	Y2	115 mm

Zoom levels

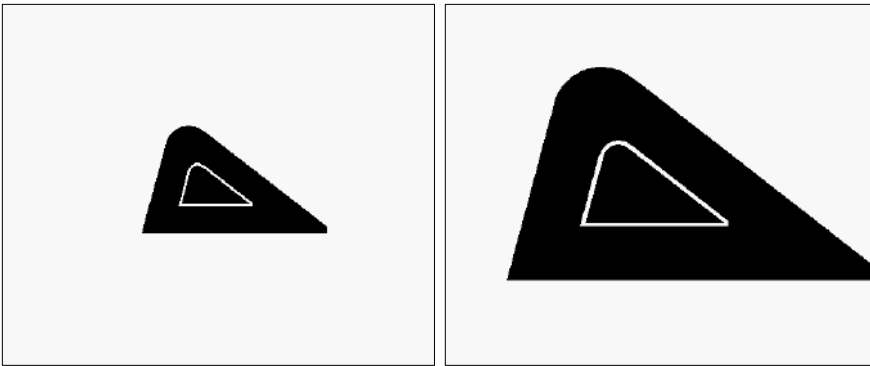

Technical data

Part No	735-0097-97-0279
Size	42 kB
Gauge (default)	8 mm
Aiming mark diameter	
Manufacture	
Manufacture Part No	

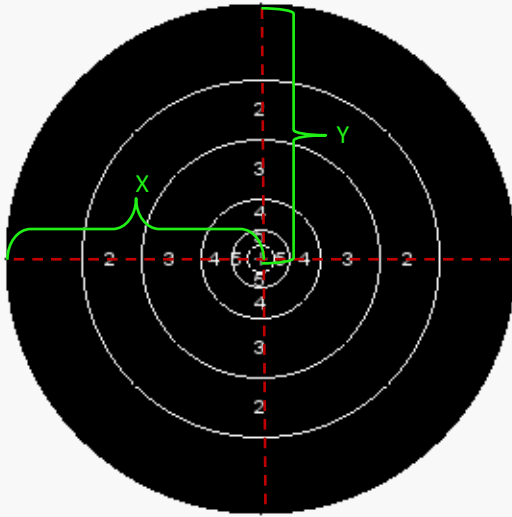

Diameter (mm)	Value
46,6	5.1
93,4	5
186,6	4
373,4	3
560	2
ROT	1

X	400 mm
Y	400 mm

Zoom levels

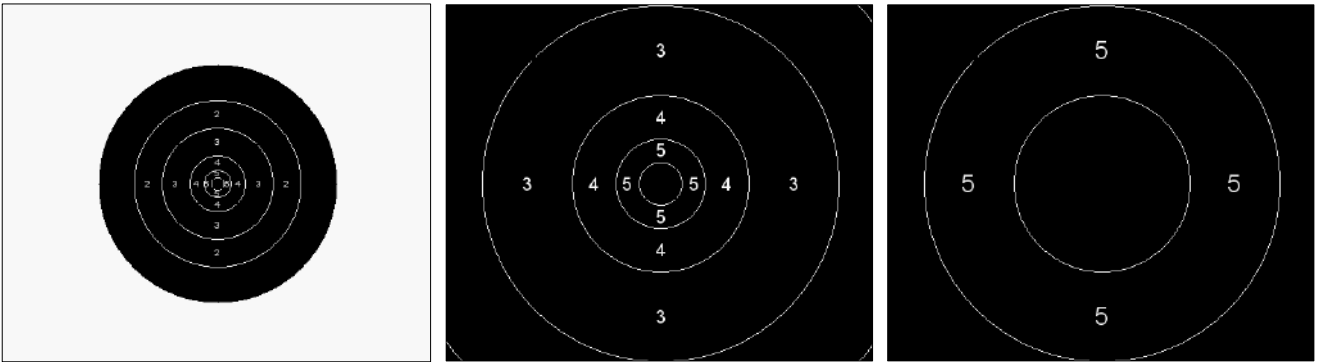

Technical data

Part No	735-0097-97-0286
Size	18 kB
Gauge (default)	7,62 mm
Aiming mark diameter	800 mm
Manufacture	
Manufacture Part No	

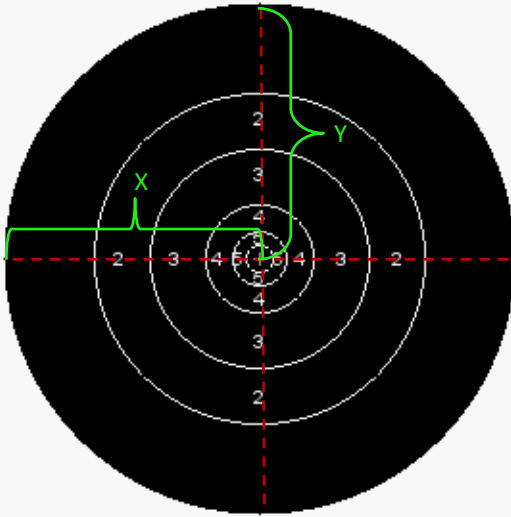

Diameter (mm)	Value
42,6	5,1
86,6	5
173,4	4
346,6	3
520	2
ROT	1

X	373,3 mm
Y	373,3 mm

Zoom levels

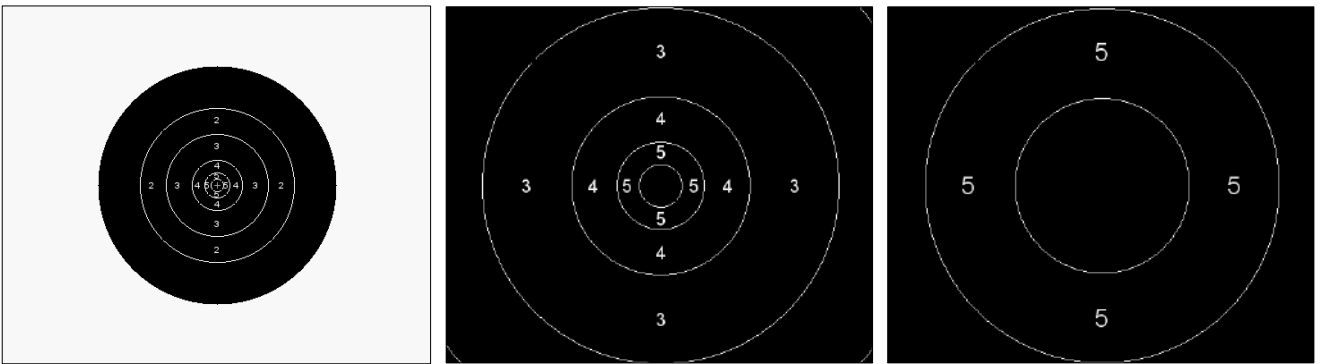

Technical data

Part No	735-0097-97-0287
Size	18 kB
Gauge (default)	7,62 mm
Aiming mark diameter	746,6 mm
Manufacture	
Manufacture Part No	

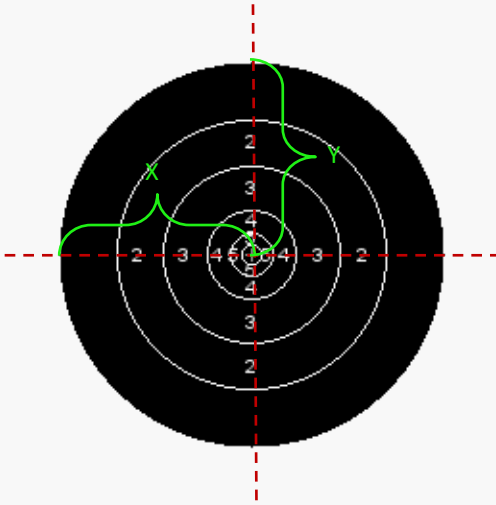

Diameter (mm)	Value
35	5,1
70	5
140	4
280	3
420	2
ROT	1

X	300 mm
Y	300 mm

Zoom levels

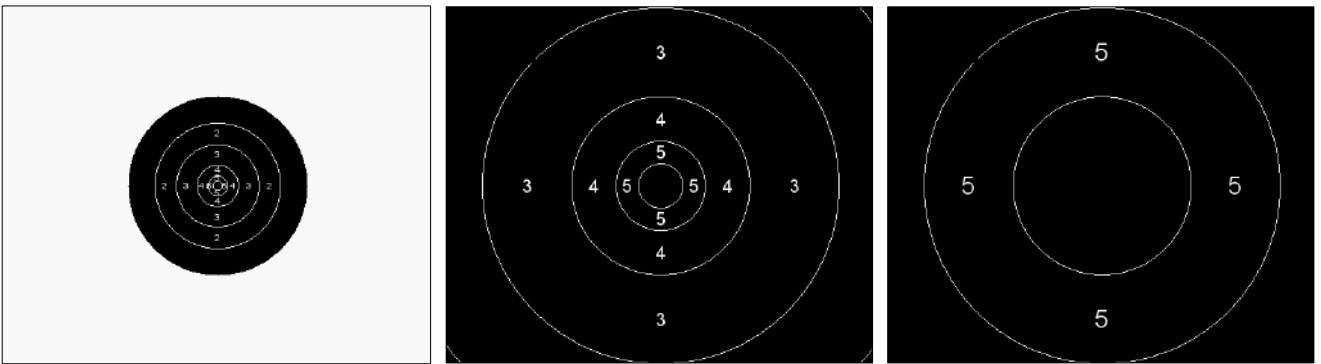

Technical data

Part No	735-0097-97-0288
Size	18 kB
Gauge (default)	7,62 mm
Aiming mark diameter	600 mm
Manufacture	
Manufacture Part No	

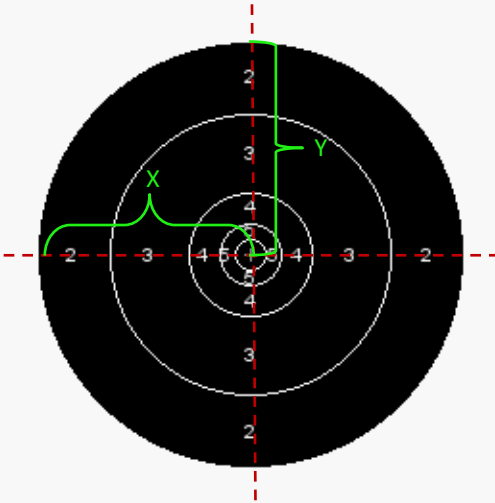

Diameter (mm)	Value
72	5,1
145	5
290	4
660	3
1000	2
ROT	1

X	500 mm
Y	500 mm

Zoom levels

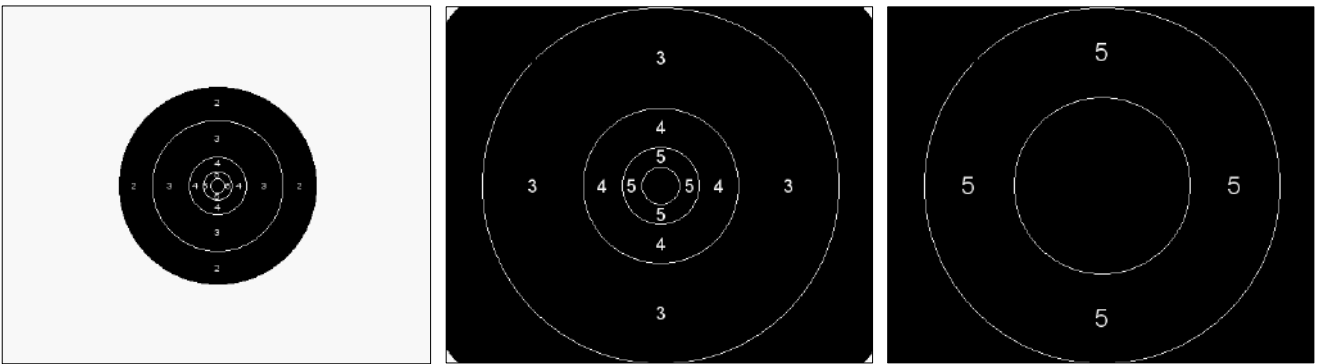

Technical data

Part No	735-0097-97-0289
Size	18 kB
Gauge (default)	7,62 mm
Aiming mark diameter	1000 mm
Manufacture	
Manufacture Part No	

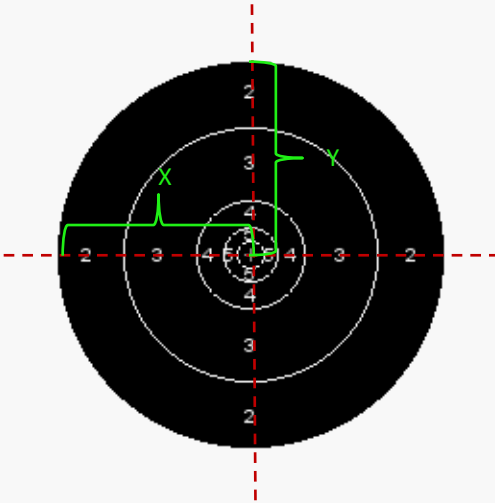

Diameter (mm)	Value
65	5,1
130	5
260	4
600	3
915	2
ROT	1

X	457,5 mm
Y	457,5 mm

Zoom levels

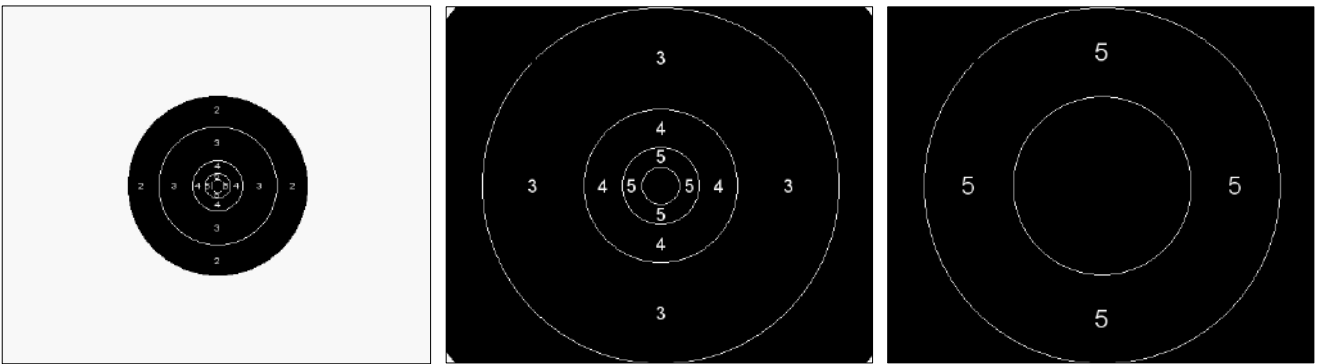

Technical data

Part No	735-0097-97-0290
Size	18 kB
Gauge (default)	7,62 mm
Aiming mark diameter	915 mm
Manufacture	
Manufacture Part No	

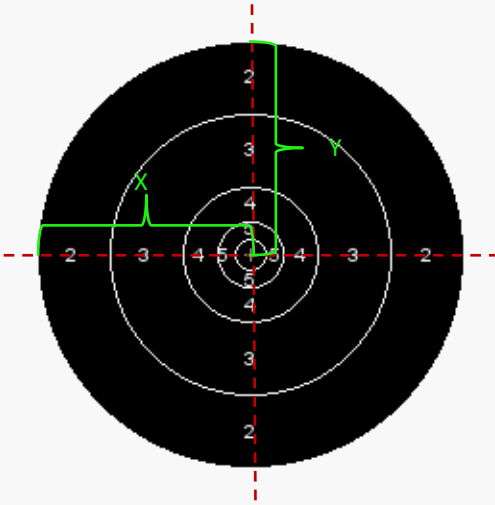

Diameter (mm)	Value
80	5,1
160	5
320	4
660	3
1000	2
ROT	1

X	500 mm
Y	500 mm

Zoom levels

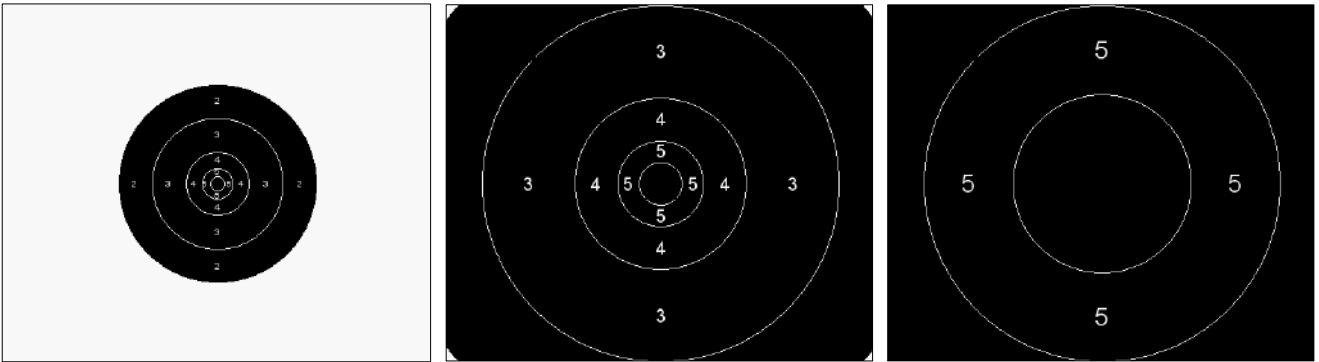

Technical data

Part No	735-0097-97-0291
Size	18 kB
Gauge (default)	7,62 mm
Aiming mark diameter	1000 mm
Manufacture	
Manufacture Part No	

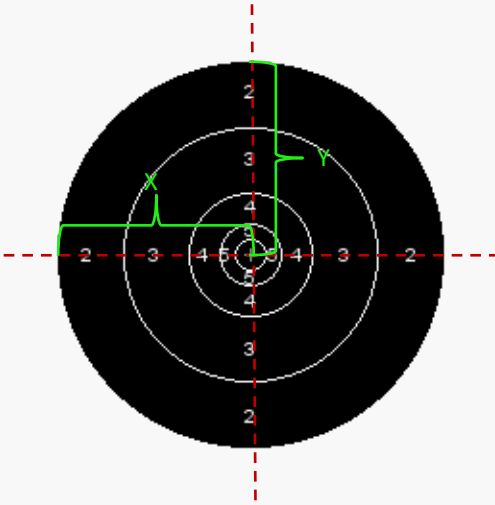

Diameter (mm)	Value
72	5,1
145	5
290	4
600	3
915	2
ROT	1

X	457,5 mm
Y	457,5 mm

Zoom levels

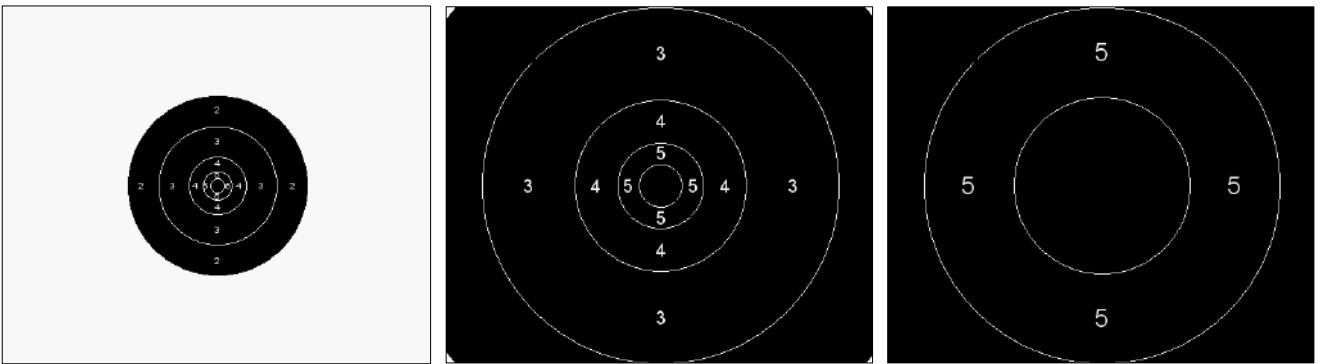

Technical data

Part No	735-0097-97-0292
Size	18 kB
Gauge (default)	7,62 mm
Aiming mark diameter	915 mm
Manufacture	
Manufacture Part No	

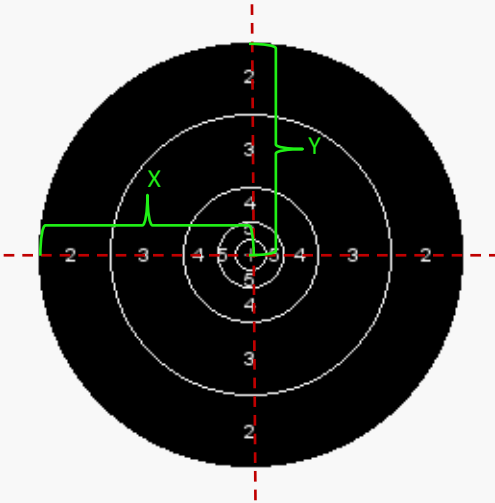

Diameter (mm)	Value
80	5,1
160	5
320	4
660	3
1000	2
ROT	1

X	500 mm
Y	500 mm

Zoom levels

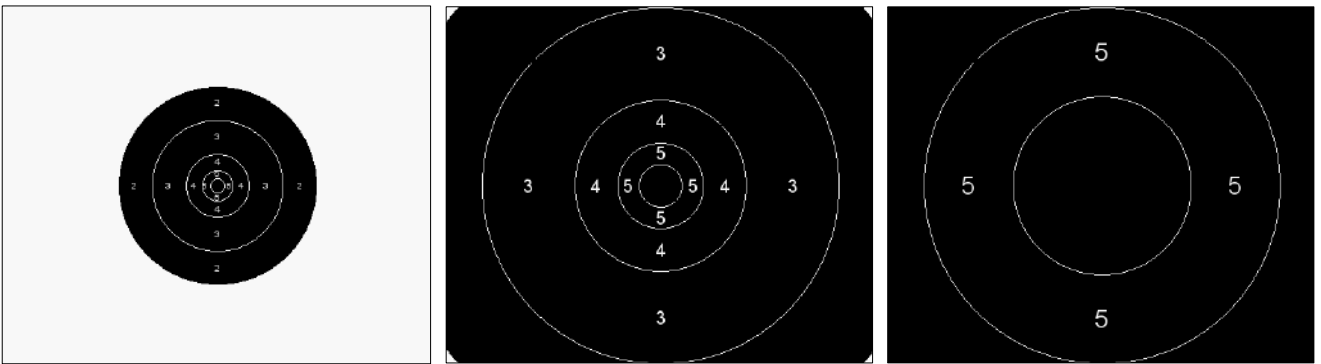

Technical data

Part No	735-0097-97-0293
Size	18 kB
Gauge (default)	7,62 mm
Aiming mark diameter	1000 mm
Manufacture	
Manufacture Part No	

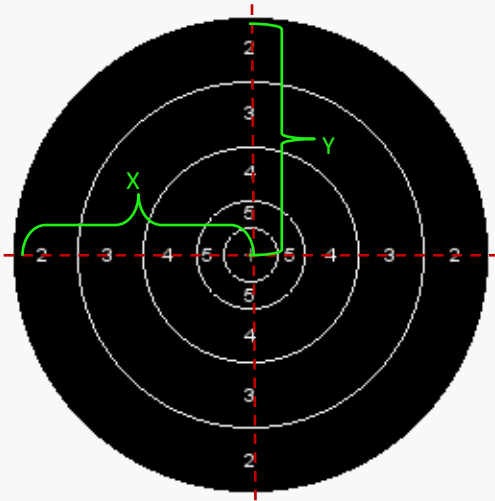

Diameter (mm)	Value
128	5,1
254	5
508	4
815	3
1118	2
ROT	1

X	559 mm
Y	559 mm

Zoom levels

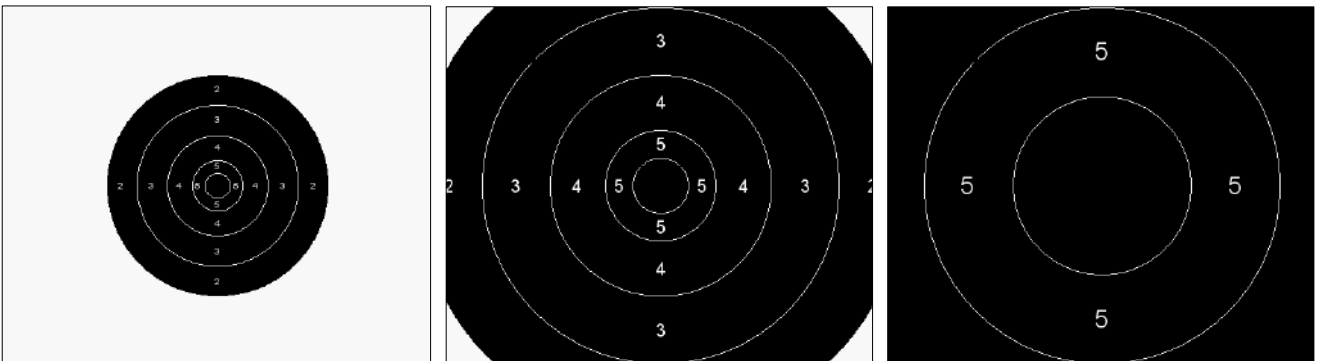

Technical data

Part No	735-0097-97-0294
Size	18 kB
Gauge (default)	7,62 mm
Aiming mark diameter	1118 mm
Manufacture	
Manufacture Part No	

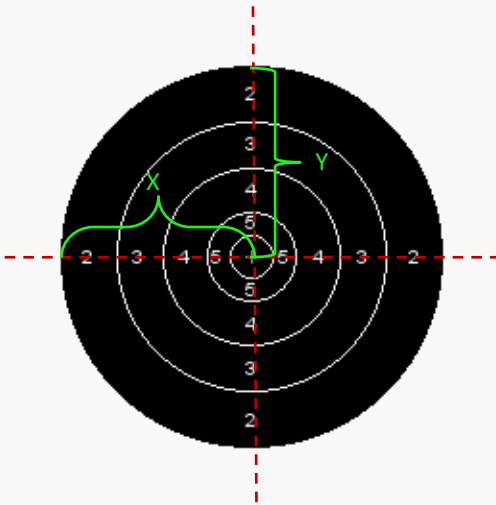

Diameter (mm)	Value
70	5,1
140	5
280	4
420	3
600	2
ROT	1

X	300 mm
Y	300 mm

Zoom levels

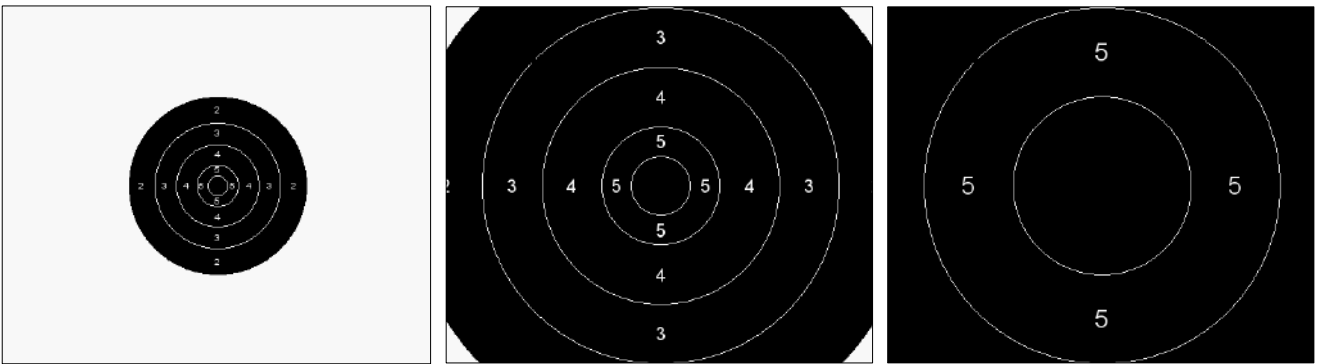

Technical data

Part No	735-0097-97-0295
Size	18 kB
Gauge (default)	7,62 mm
Aiming mark diameter	600 mm
Manufacture	
Manufacture Part No	

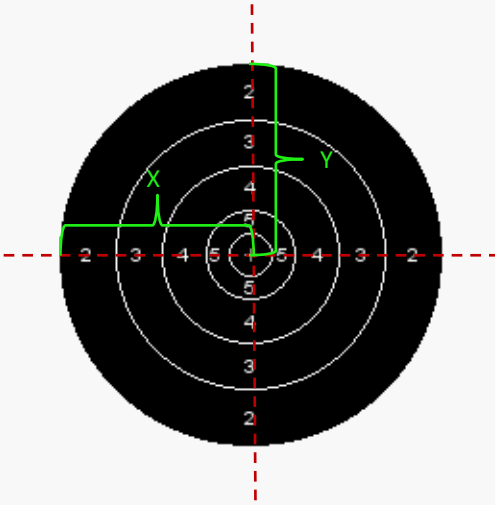

Diameter (mm)	Value
65	5,1
130	5
260	4
390	3
560	2
ROT	1

X	280 mm
Y	280 mm

Zoom levels

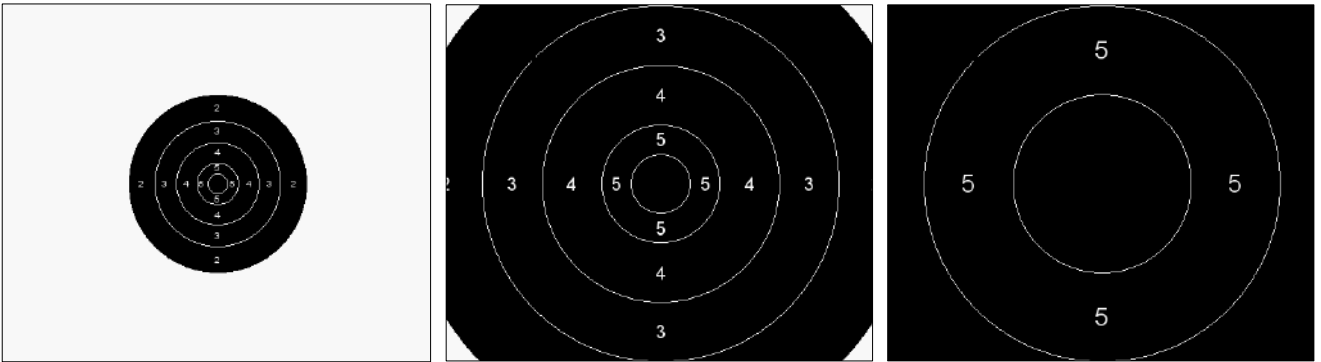

Technical data

Part No	735-0097-97-0296
Size	18 kB
Gauge (default)	7,62 mm
Aiming mark diameter	560 mm
Manufacture	
Manufacture Part No	

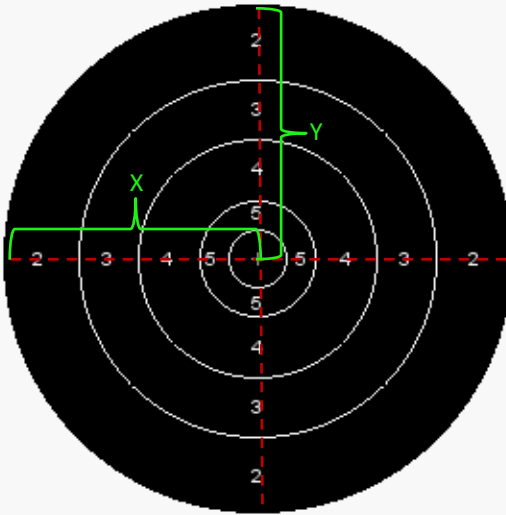

Diameter (mm)	Value
95	5,1
185	5
375	4
560	3
800	2
ROT	1

X	400 mm
Y	400 mm

Zoom levels

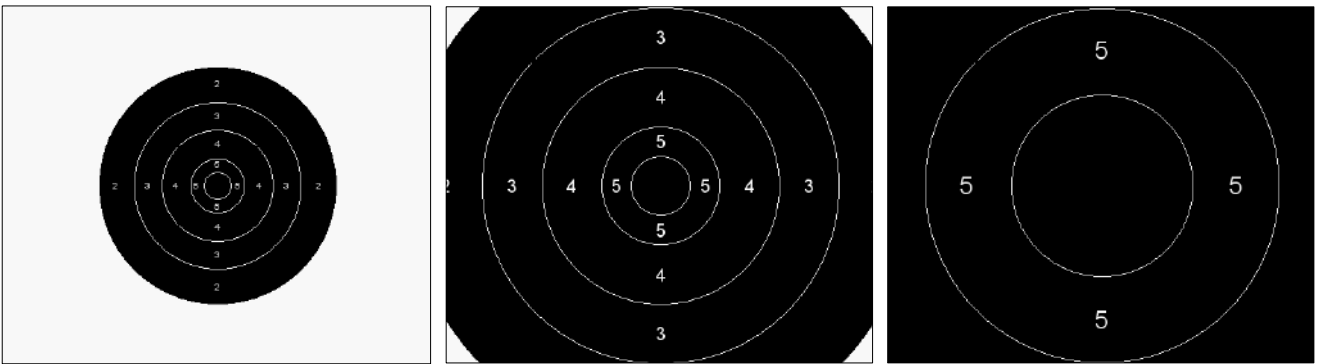

Technical data

Part No	735-0097-97-0297
Size	18 kB
Gauge (default)	7,62 mm
Aiming mark diameter	800 mm
Manufacture	
Manufacture Part No	

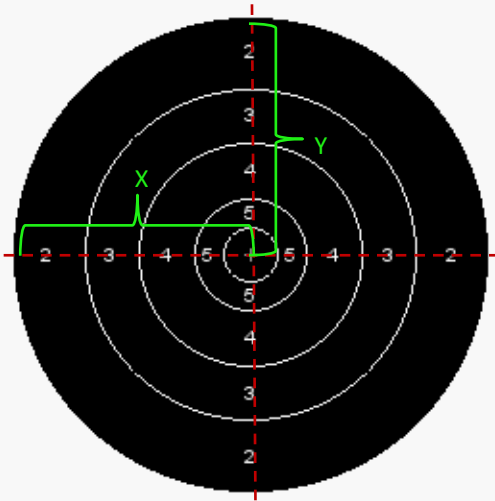

Diameter (mm)	Value
85	5,1
175	5
350	4
520	3
745	2
ROT	1

X	372,5 mm
Y	372,5 mm

Zoom levels

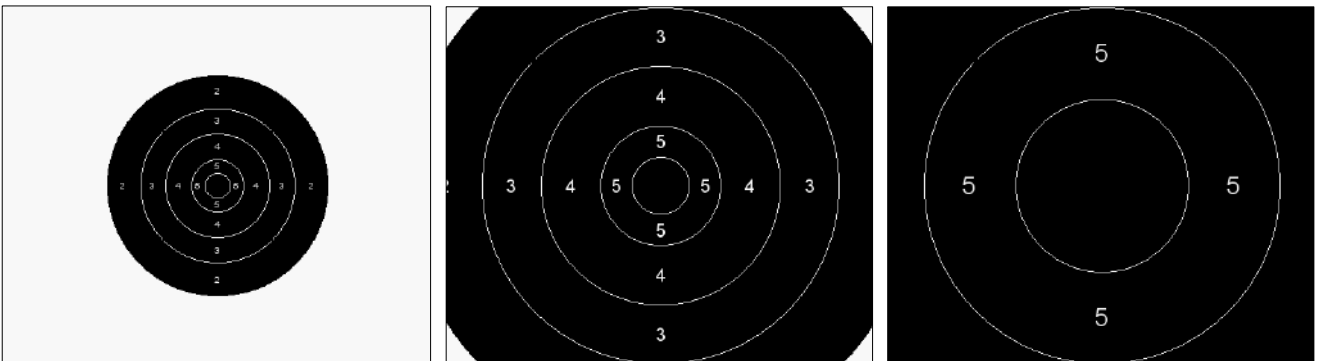

Technical data

Part No	735-0097-97-0298
Size	18 kB
Gauge (default)	7,62 mm
Aiming mark diameter	745 mm
Manufacture	
Manufacture Part No	

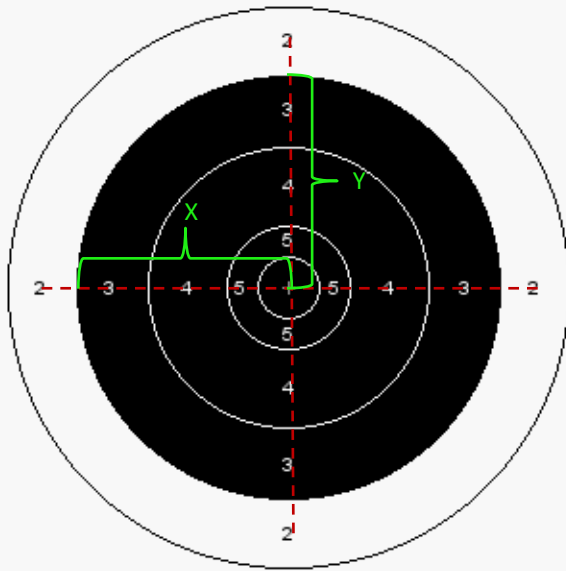

Diameter (mm)	Value
145	5,1
290	5
660	4
1000	3
1320	2
ROT	1

X	500 mm
Y	500 mm

Zoom levels

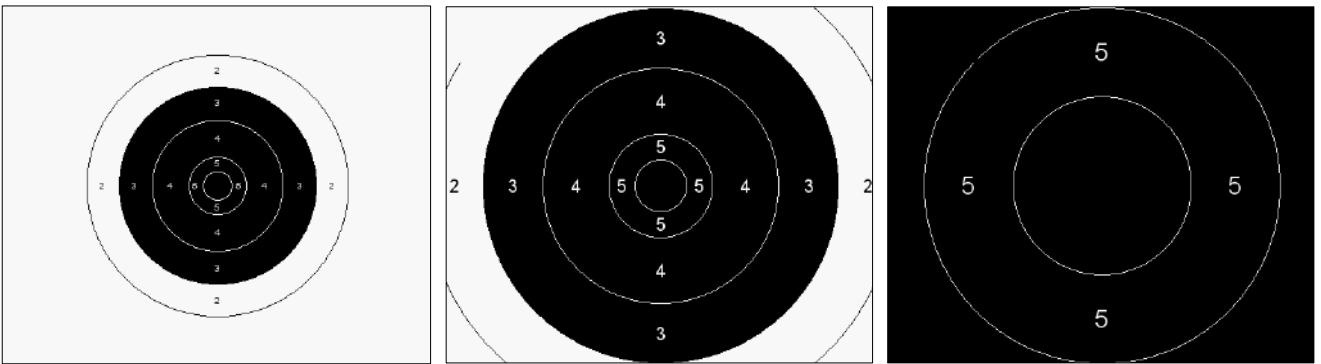

Technical data

Part No	735-0097-97-0299
Size	18 kB
Gauge (default)	7,62 mm
Aiming mark diameter	1000 mm
Manufacture	
Manufacture Part No	

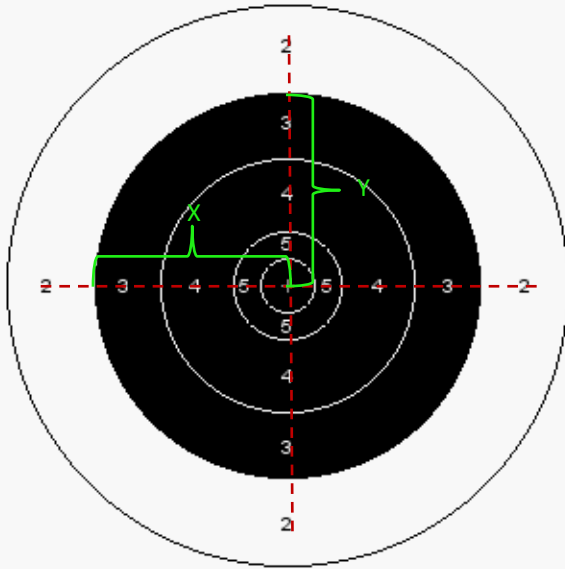

Diameter (mm)	Value
130	5,1
260	5
600	4
915	3
1320	2
ROT	1

X	457,5 mm
Y	457,5 mm

Zoom levels

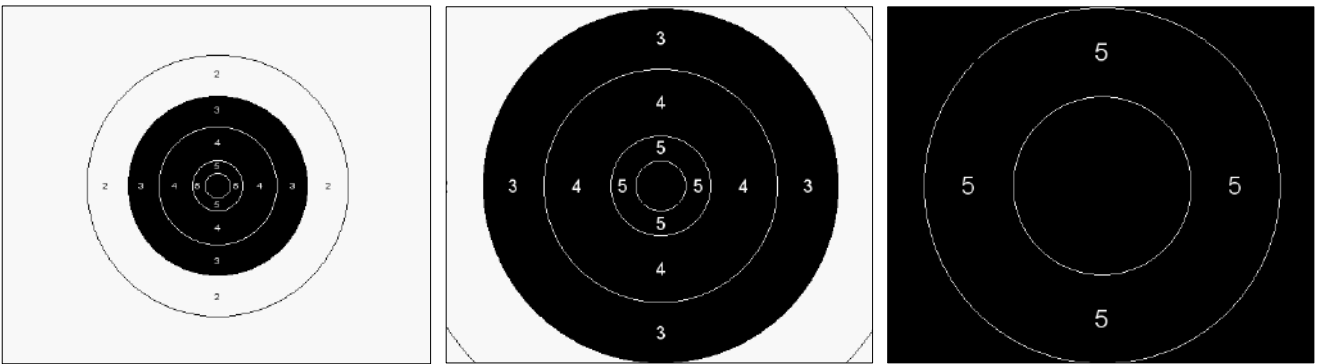

Technical data

Part No	735-0097-97-0300
Size	18 kB
Gauge (default)	7,62 mm
Aiming mark diameter	915 mm
Manufacture	
Manufacture Part No	

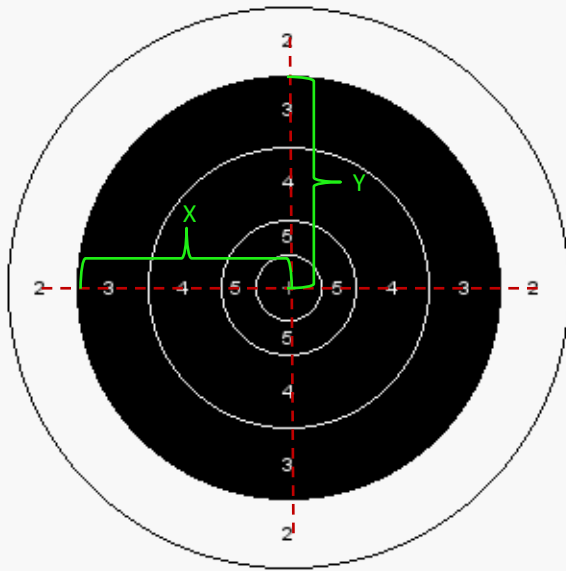

Diameter (mm)	Value
160	5,1
320	5
660	4
1000	3
1320	2
ROT	1

X	500 mm
Y	500 mm

Zoom levels

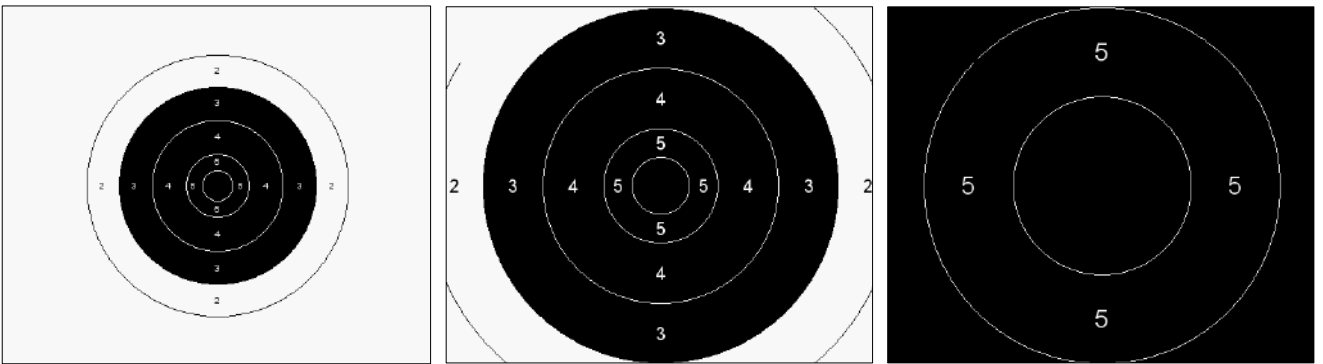

Technical data

Part No	735-0097-97-0301
Size	18 kB
Gauge (default)	7,62 mm
Aiming mark diameter	1000 mm
Manufacture	
Manufacture Part No	

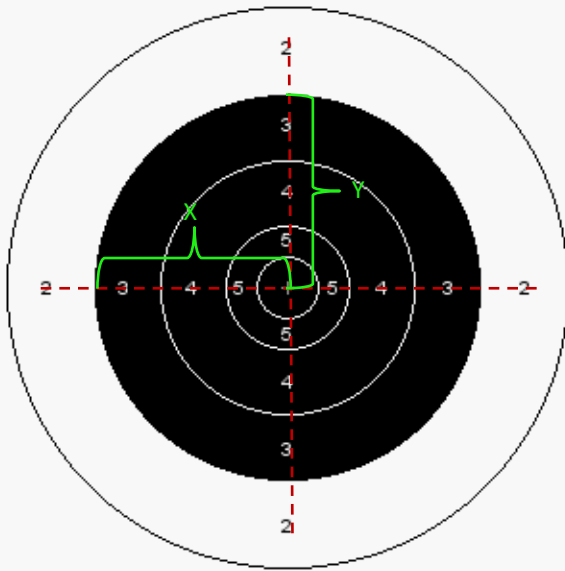

Diameter (mm)	Value
145	5,1
290	5
600	4
915	3
1320	2
ROT	1

X	457,5 mm
Y	457,5 mm

Zoom levels

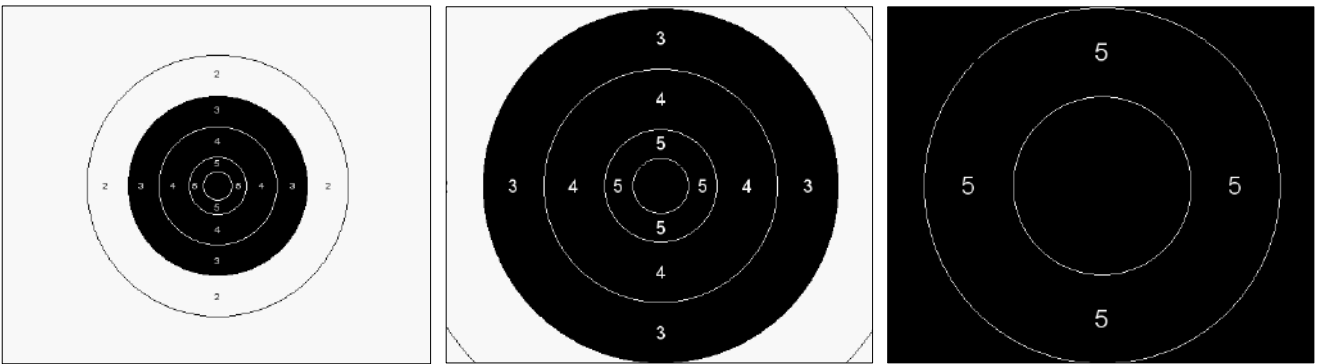

Technical data

Part No	735-0097-97-0302
Size	18 kB
Gauge (default)	7,62 mm
Aiming mark diameter	915 mm
Manufacture	
Manufacture Part No	

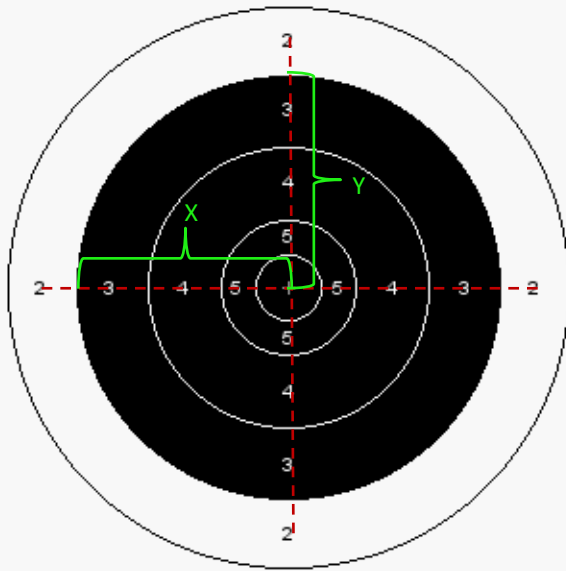

Diameter (mm)	Value
160	5,1
320	5
660	4
1000	3
1320	2
ROT	1

X	500 mm
Y	500 mm

Zoom levels

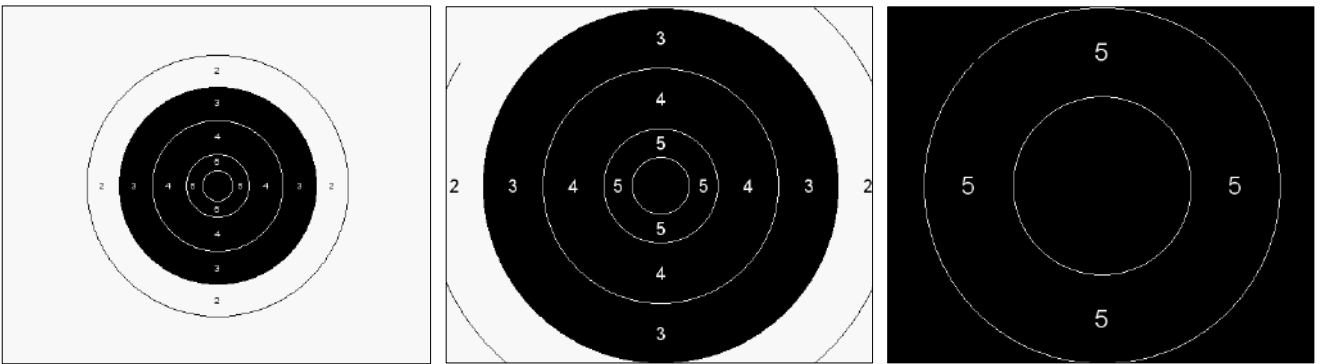

Technical data

Part No	735-0097-97-0303
Size	18 kB
Gauge (default)	7,62 mm
Aiming mark diameter	1000 mm
Manufacture	
Manufacture Part No	

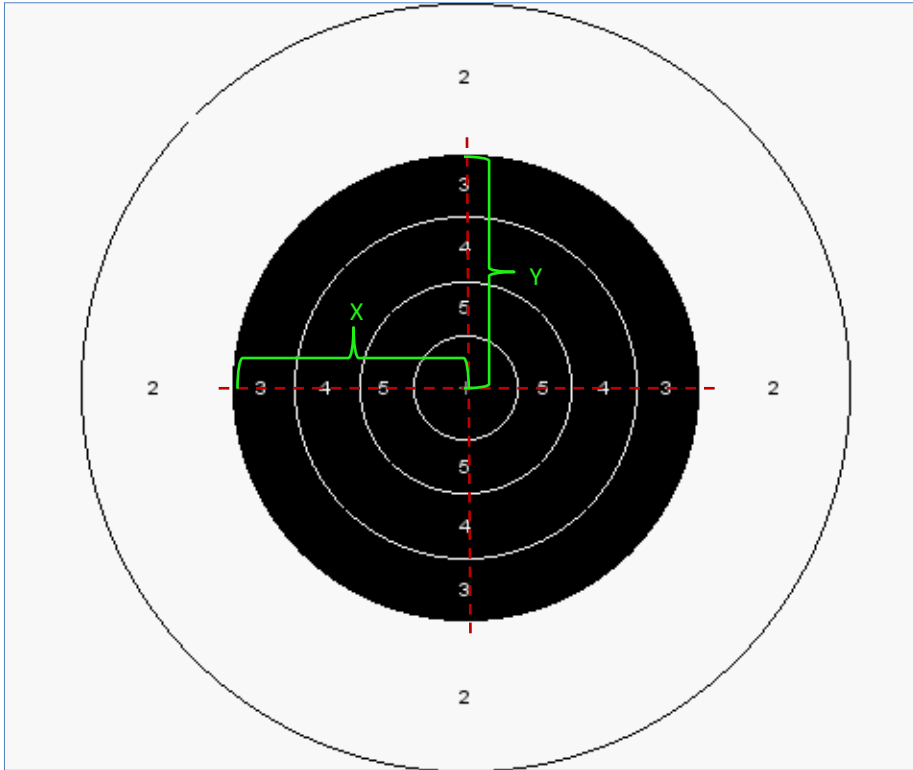

Diameter (mm)	Value
255	5,1
510	5
815	4
1120	3
1830	2
ROT	1

X	560 mm
Y	560 mm

Zoom levels

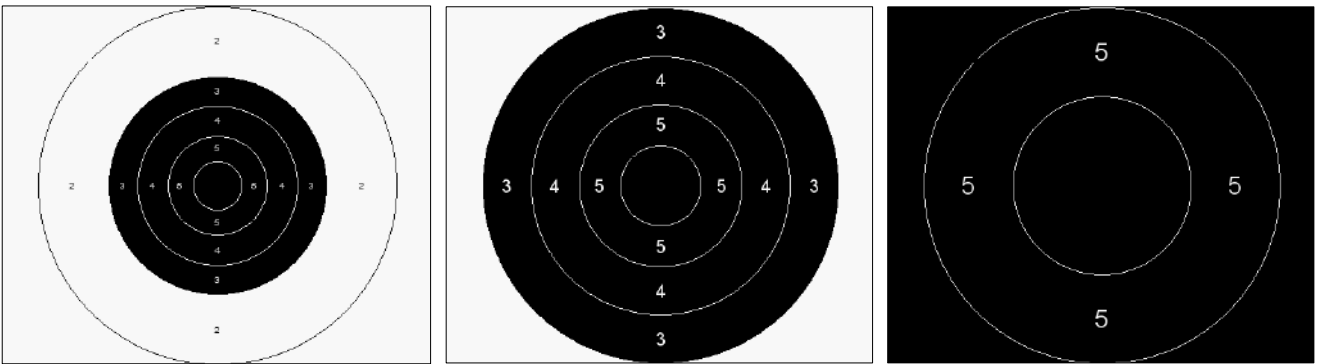

Technical data

Part No	735-0097-97-0304
Size	18 kB
Gauge (default)	7,62 mm
Aiming mark diameter	1120 mm
Manufacture	
Manufacture Part No	

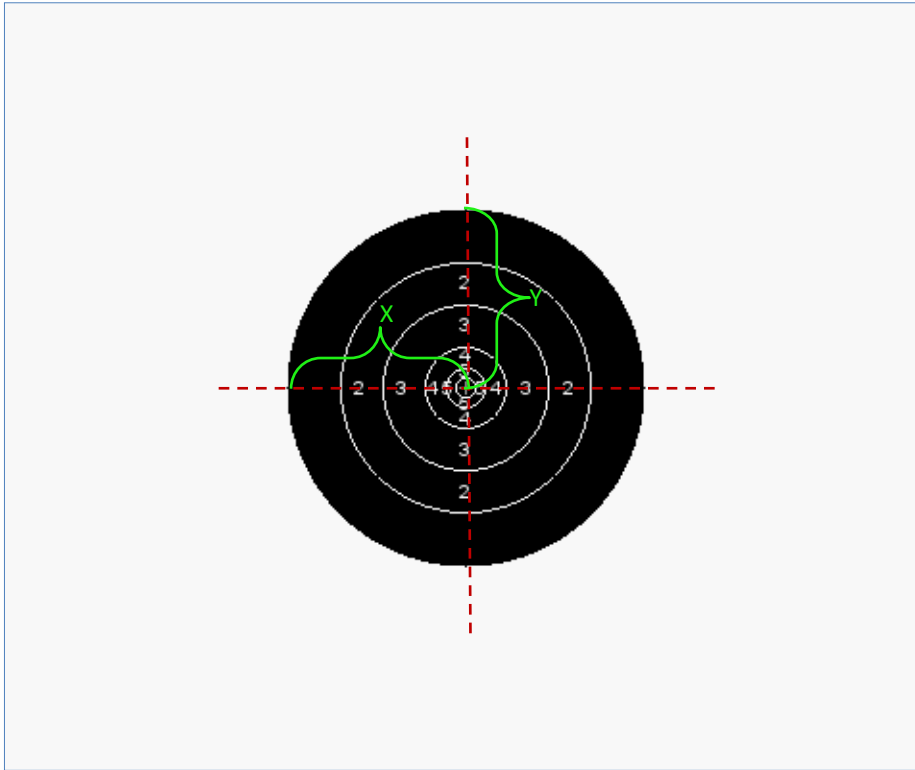

Diameter (mm)	Value
32	5,1
65	5
130	4
260	3
390	2
ROT	1

X	280 mm
Y	280 mm

Zoom levels

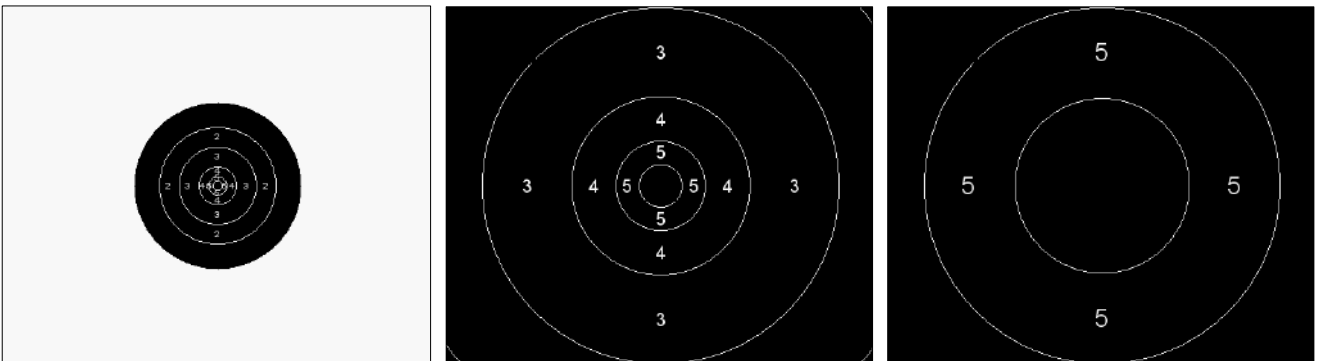

Technical data

Part No	735-0097-97-0306
Size	18 kB
Gauge (default)	7,62 mm
Aiming mark diameter	560 mm
Manufacture	
Manufacture Part No	

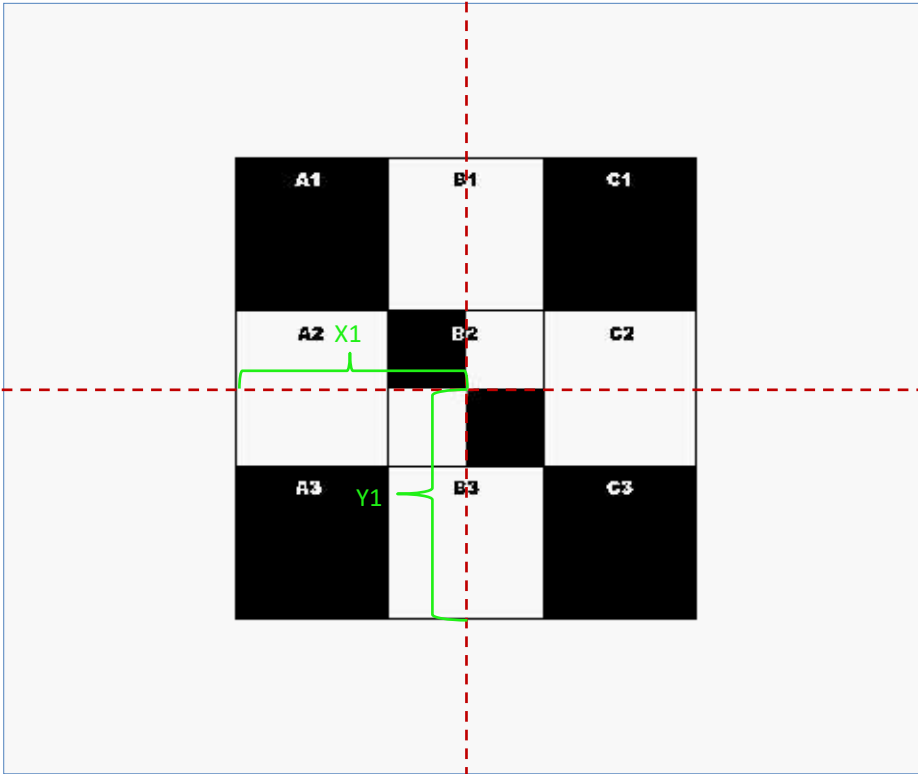

Shot text	Value
A1	1
A2	1
A3	1
B1	1
B2	1
B3	1
C1	1
C2	1
C3	1

X1	450 mm
Y1	450 mm

Zoom levels

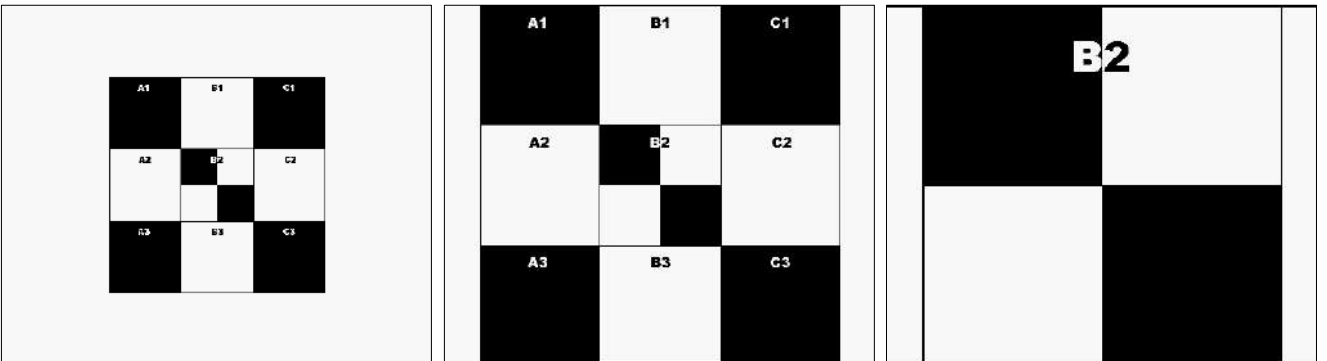

Technical data

Part No	735-0097-97-0329
Size	100 kB
Gauge (default)	0,1mm
Aiming mark diameter	
Manufacture	
Manufacture Part No	

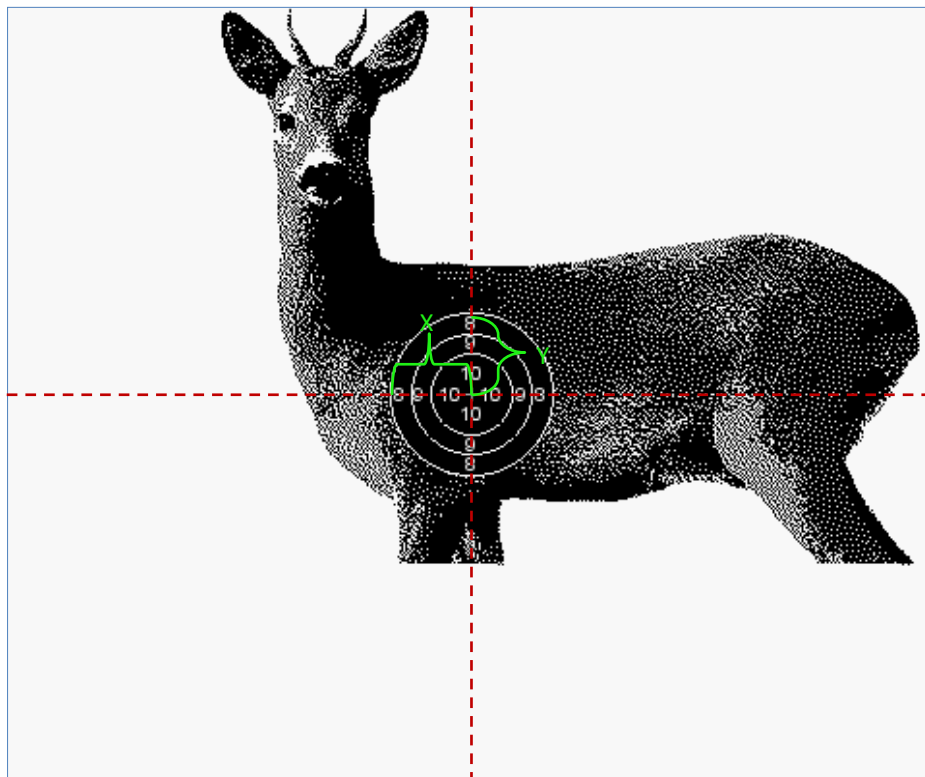

Diameter (mm)	Value
100	10
150	9
200	8

X	100 mm
Y	100 mm

Zoom levels

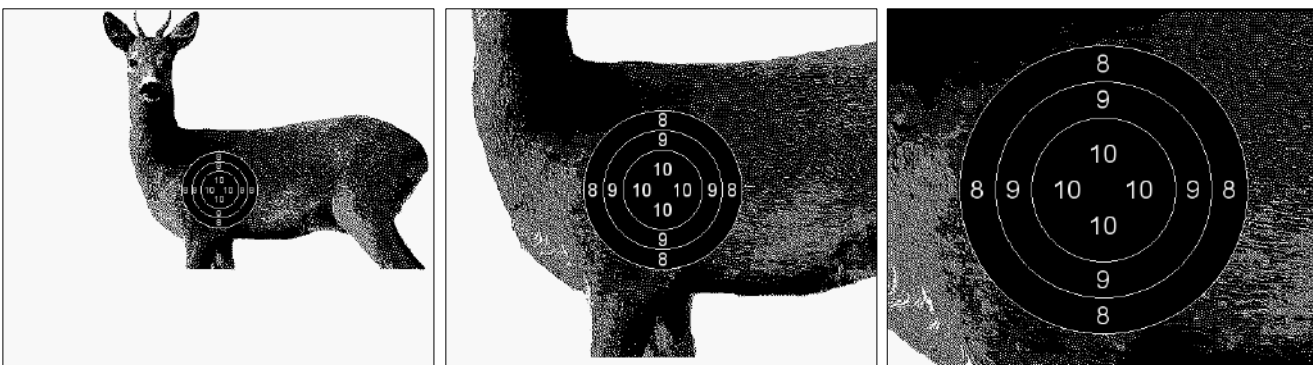

Technical data

Part No	735-0097-97-0335
Size	131 kB
Gauge (default)	8 mm
Aiming mark diameter	
Manufacture	
Manufacture Part No	

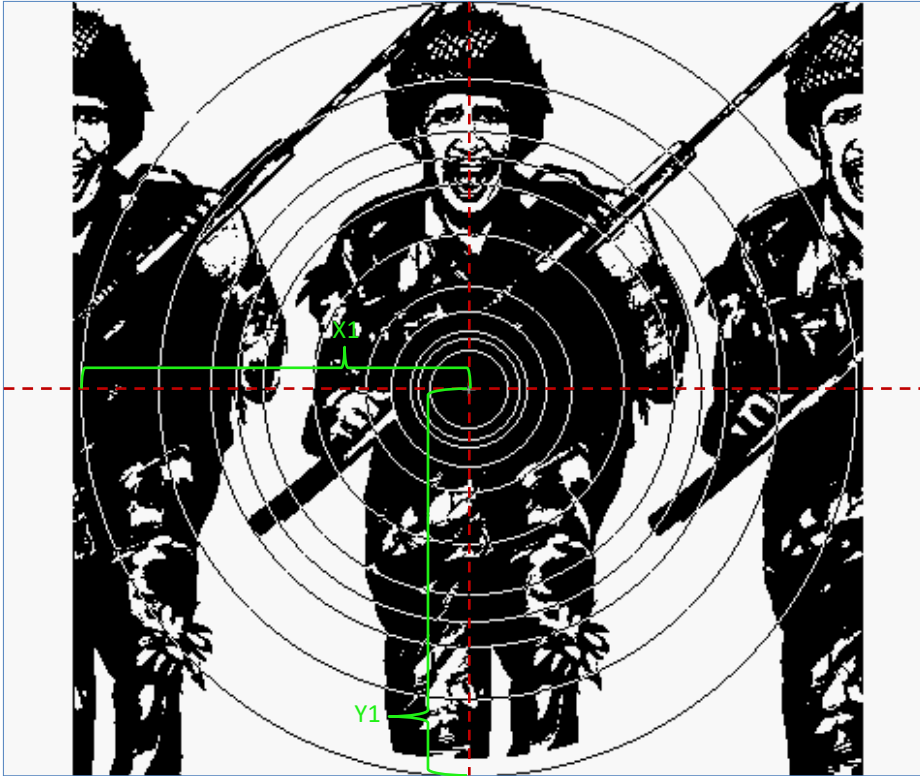

Diameter (mm)	Value
120	3
160	3
180	3
240	3
320	3
480	3
640	2
720	1
800	1
960	1
1200	1
ROT	0

X1	600 mm
Y1	600 mm

Zoom levels

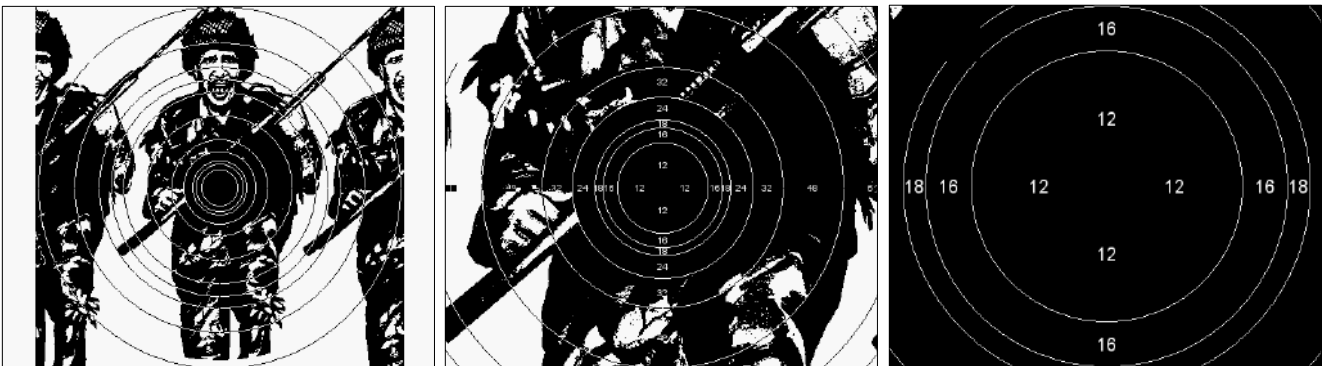

Technical data

Part No	735-0097-97-0359
Size	75 kB
Gauge (default)	5 mm
Aiming mark diameter	
Manufacture	
Manufacture Part No	

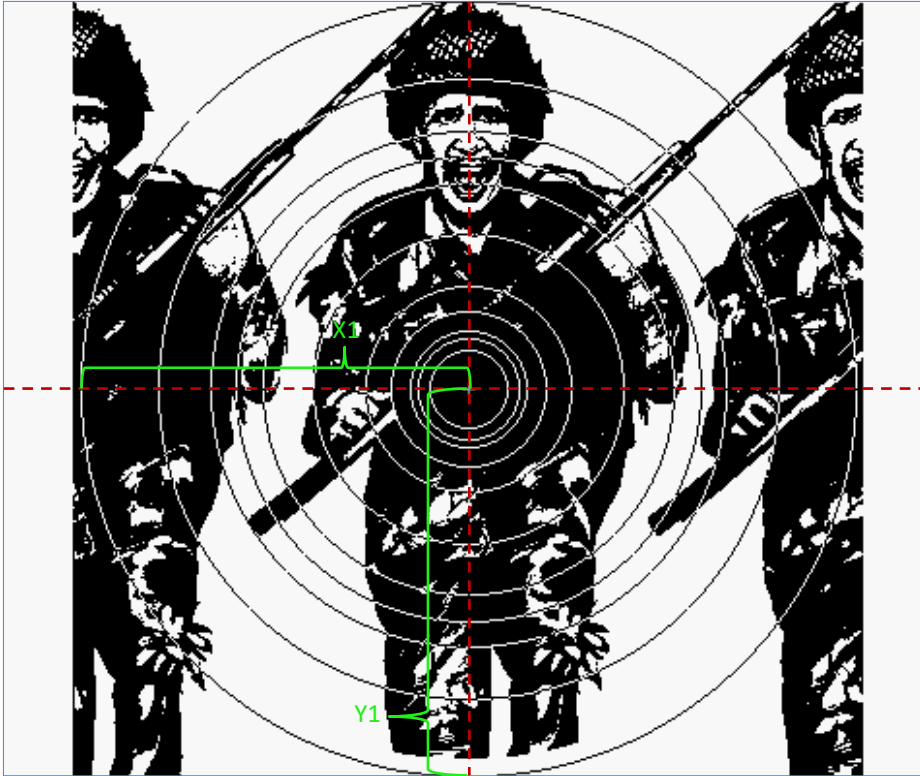

Diameter (mm)	Value
120	3
160	3
180	3
240	3
320	2
480	1
640	1
720	1
800	1
960	1
1200	1
ROT	0

X1	600 mm
Y1	600 mm

Zoom levels

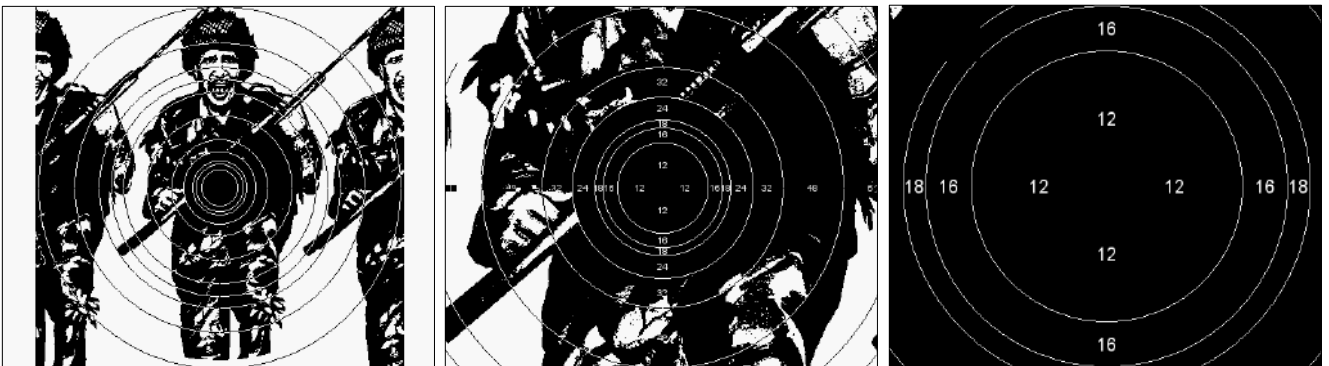

Technical data

Part No	735-0097-97-0360
Size	75 kB
Gauge (default)	5 mm
Aiming mark diameter	
Manufacture	
Manufacture Part No	

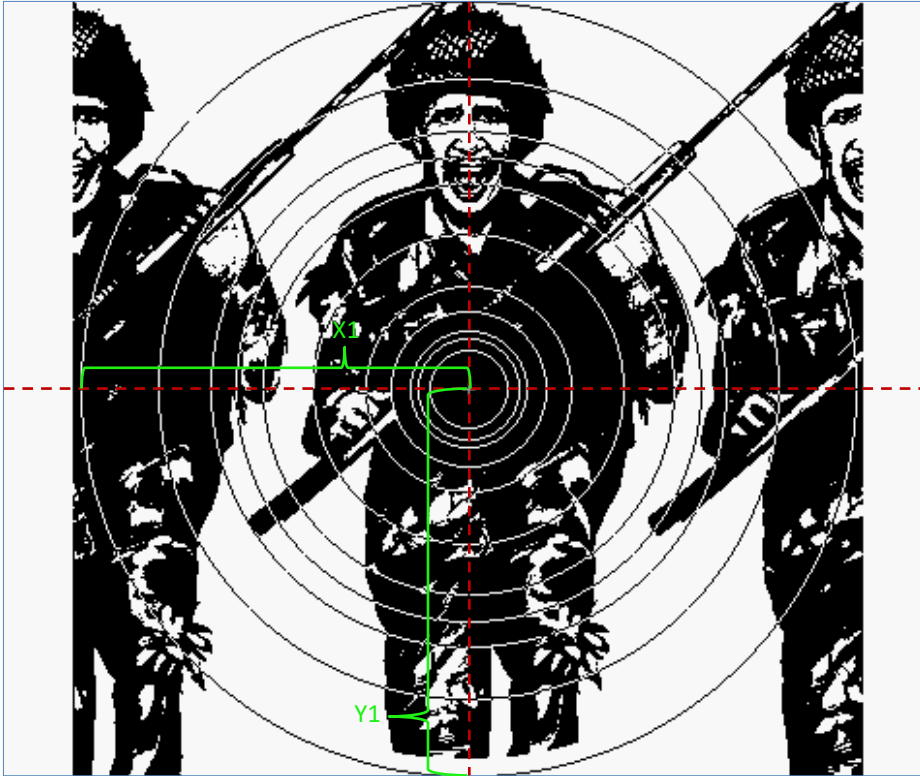

Diameter (mm)	Value
120	3
160	3
180	3
240	3
320	3
480	3
640	3
720	3
800	3
960	2
1200	1
ROT	0

X1	600 mm
Y1	600 mm

Zoom levels

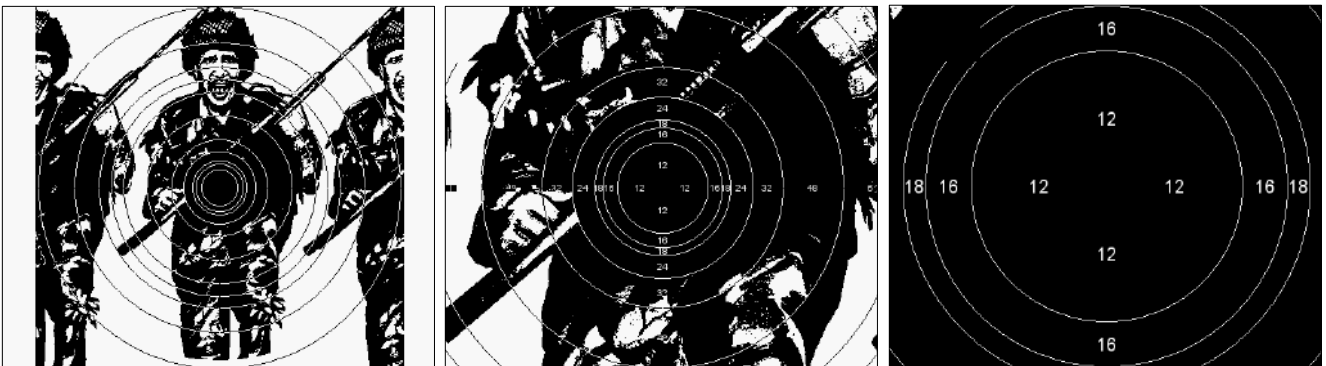

Technical data

Part No	735-0097-97-0361
Size	75 kB
Gauge (default)	5 mm
Aiming mark diameter	
Manufacture	
Manufacture Part No	

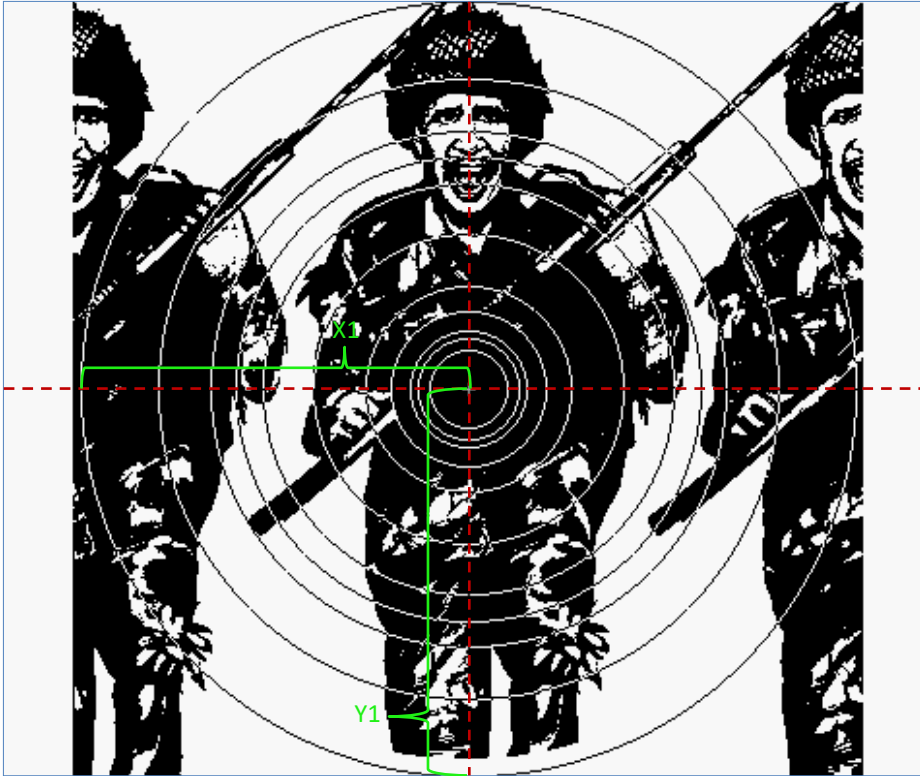

Diameter (mm)	Value
120	1
160	1
180	1
240	1
320	1
480	1
640	1
720	1
800	1
960	1
1200	1
ROT	0

X1	600 mm
Y1	600 mm

Zoom levels

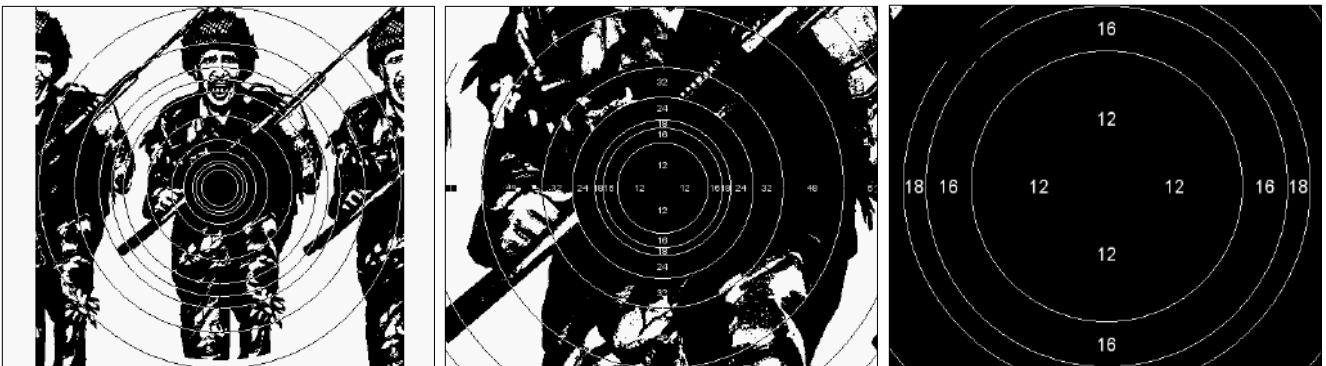

Technical data

Part No	735-0097-97-0362
Size	75 kB
Gauge (default)	5 mm
Aiming mark diameter	
Manufacture	
Manufacture Part No	

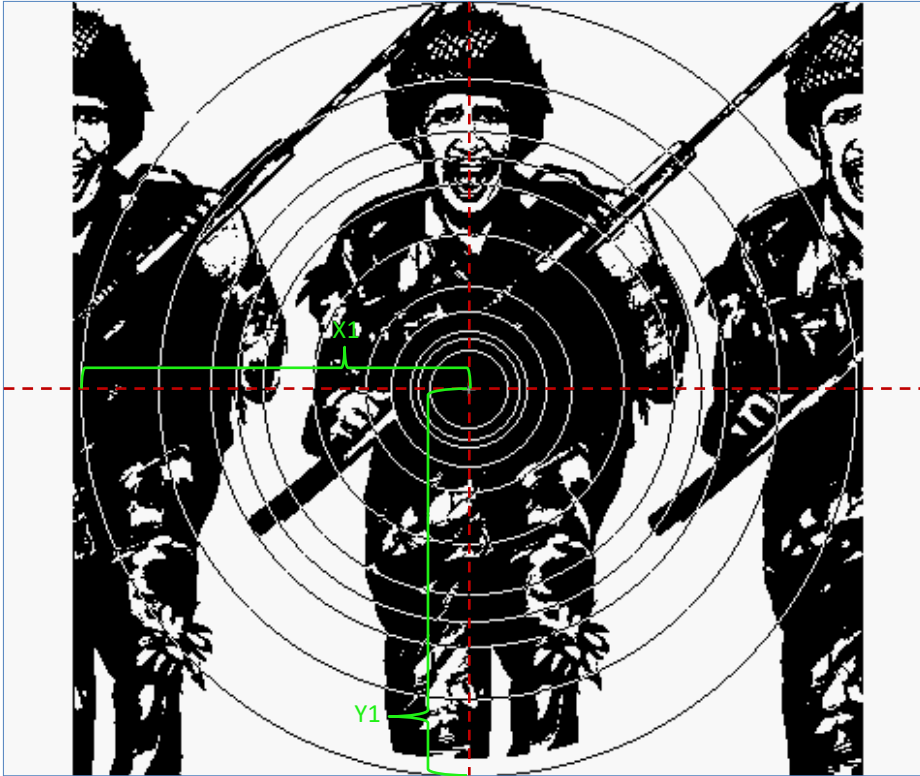

Diameter (mm)	Value
120	3
160	3
180	3
240	3
320	3
480	2
640	1
720	1
800	1
960	1
1200	1
ROT	0

X1	600 mm
Y1	600 mm

Zoom levels

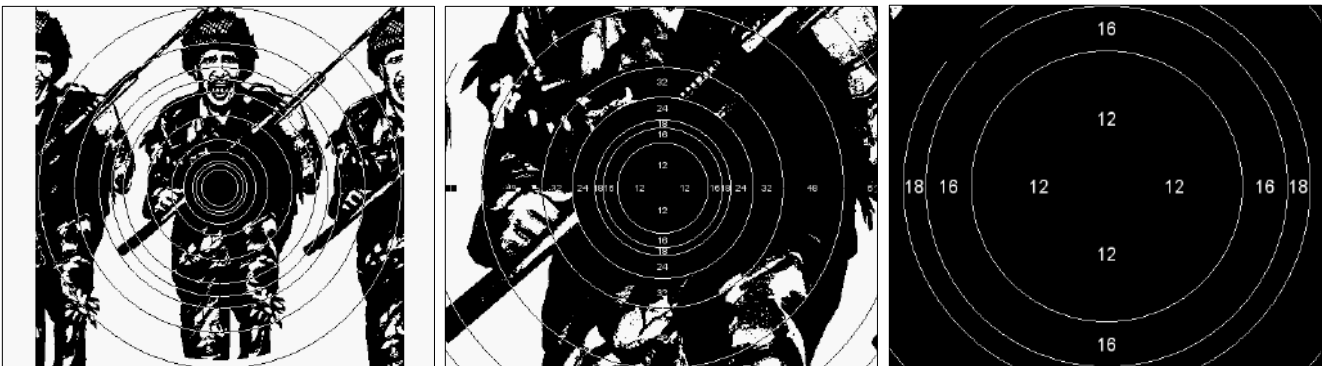

Technical data

Part No	735-0097-97-0363
Size	75 kB
Gauge (default)	5 mm
Aiming mark diameter	
Manufacture	
Manufacture Part No	

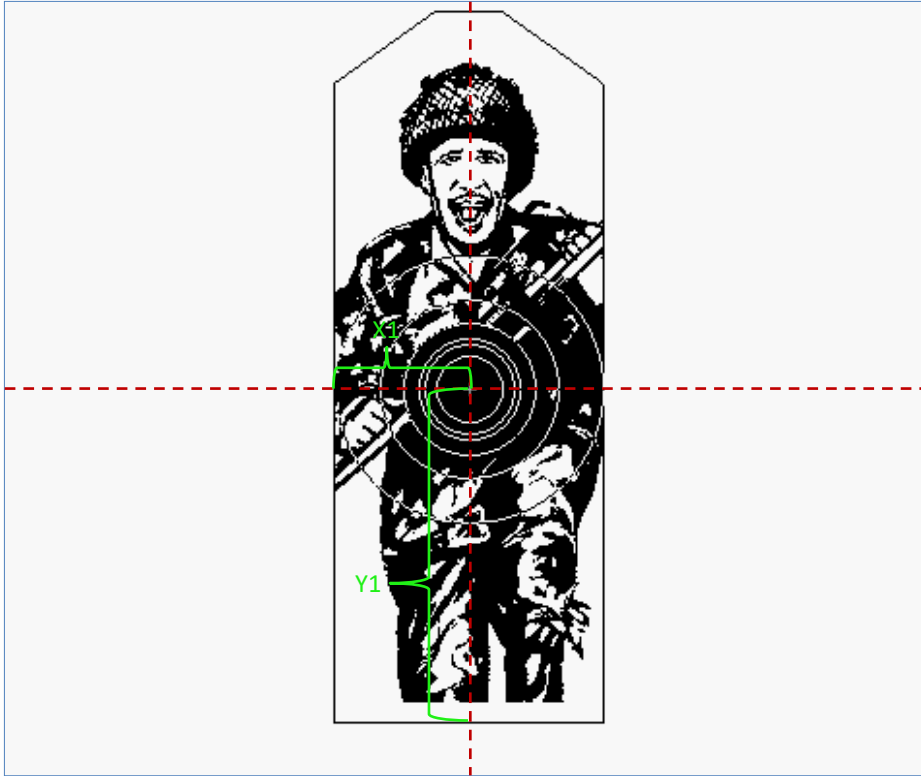

Diameter (mm)	Value
60	3
80	3
90	3
120	3
160	2
240	1
ROT	1

X1	240 mm
Y1	596,9 mm

Zoom levels



Technical data

Part No	735-0097-97-0364
Size	91 kB
Gauge (default)	5 mm
Aiming mark diameter	
Manufacture	
Manufacture Part No	

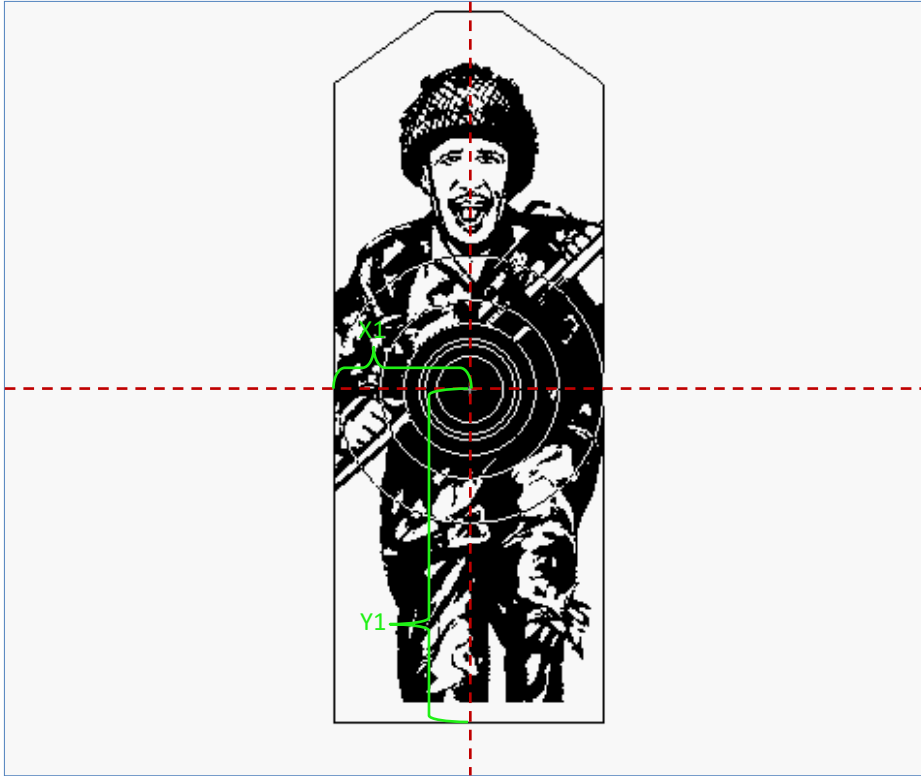

Diameter (mm)	Value
60	3
80	3
90	3
120	3
160	3
240	2
ROT	1

X1	240 mm
Y1	596,9 mm

Zoom levels



Technical data

Part No	735-0097-97-0365
Size	91 kB
Gauge (default)	5 mm
Aiming mark diameter	
Manufacture	
Manufacture Part No	

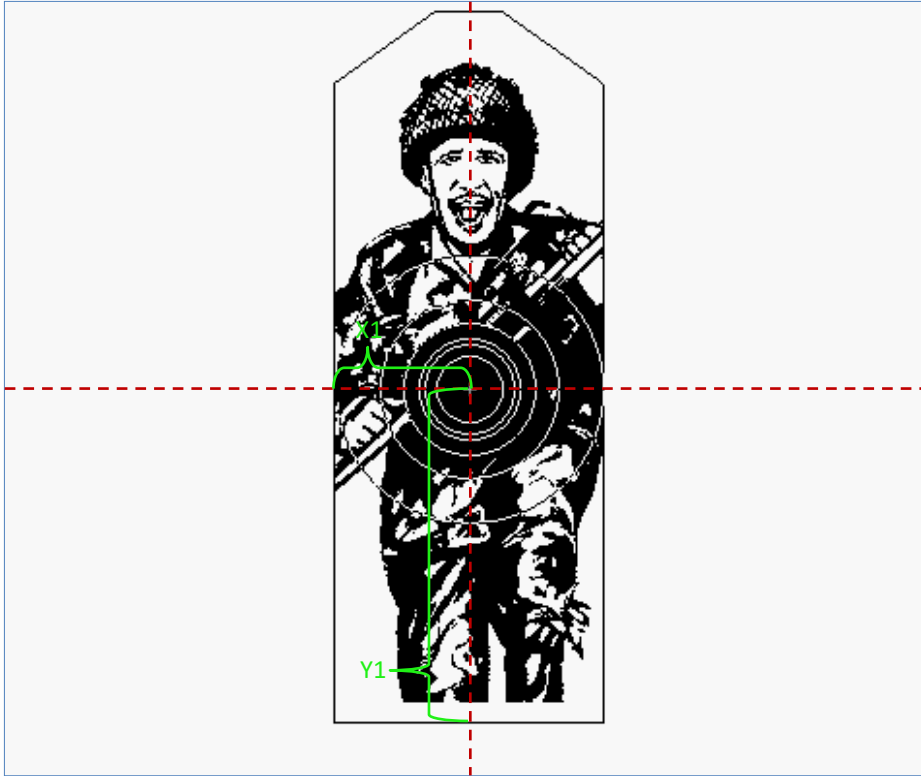

Diameter (mm)	Value
60	1
80	1
90	1
120	1
160	1
240	1
ROT	1

X1	240 mm
Y1	596,9 mm

Zoom levels



Technical data

Part No	735-0097-97-0366
Size	91 kB
Gauge (default)	5 mm
Aiming mark diameter	
Manufacture	
Manufacture Part No	

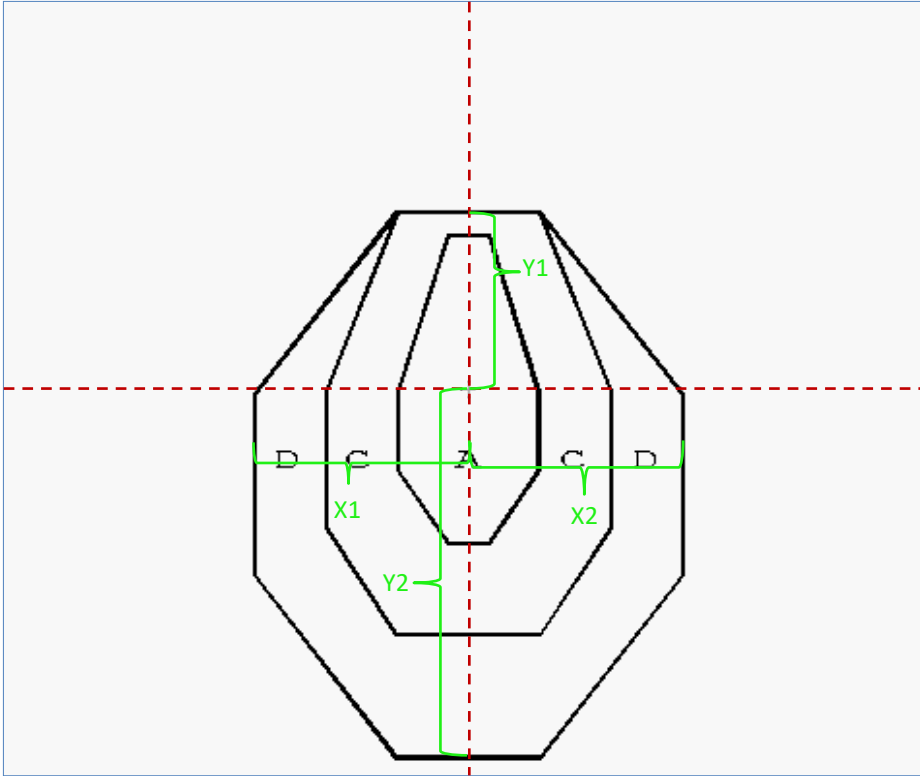

Diameter (mm)	Value
A	1
C	1
D	1
ROT	0

X1	150 mm	X2	150 mm
Y1	122,5 mm	Y2	257,5 mm

Zoom levels

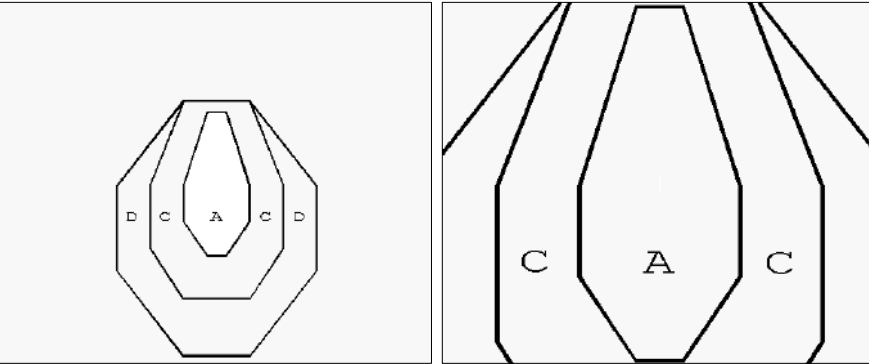

Technical data

Part No	735-0097-97-0367
Size	80 kB
Gauge (default)	8 mm
Aiming mark diameter	
Manufacture	
Manufacture Part No	

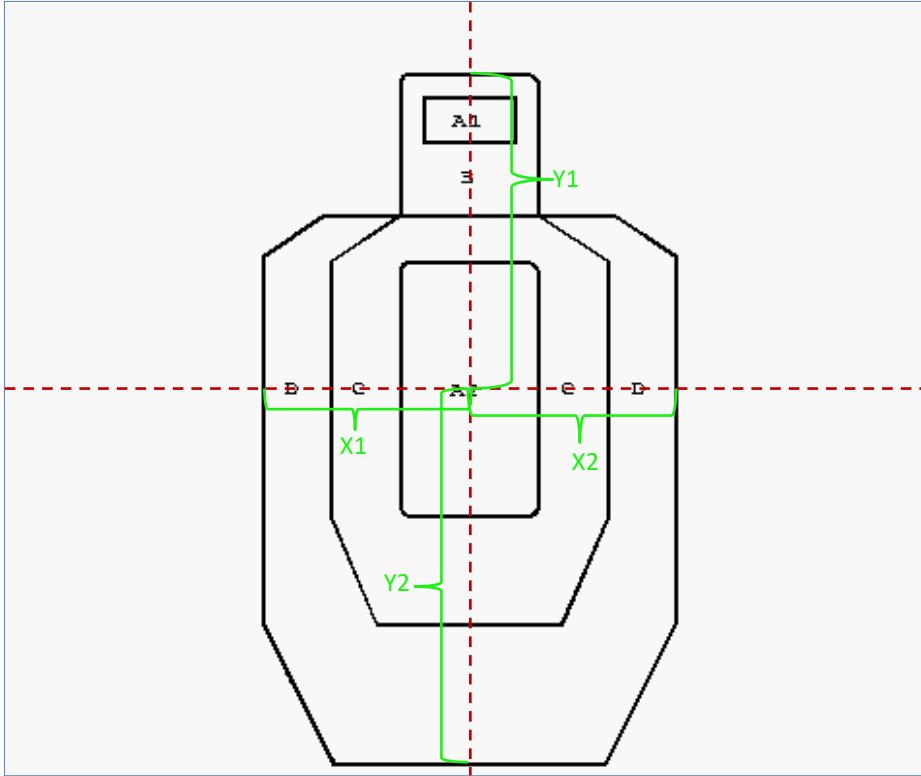

Diameter (mm)	Value
A1	1
A2	1
B	1
C	1
D	1
ROT	0

X1	222,5 mm	X2	222,5 mm
Y1	337,5 mm	Y2	402,5 mm

Zoom levels

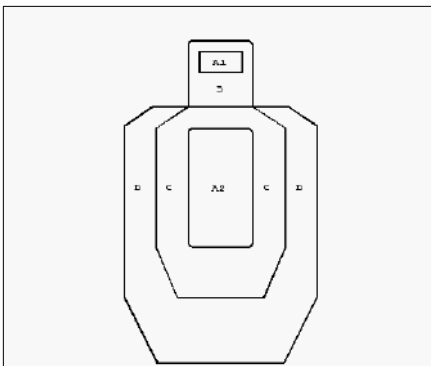

Technical data

Part No	735-0097-97-0368
Size	74 kB
Gauge (default)	8 mm
Aiming mark diameter	
Manufacture	
Manufacture Part No	

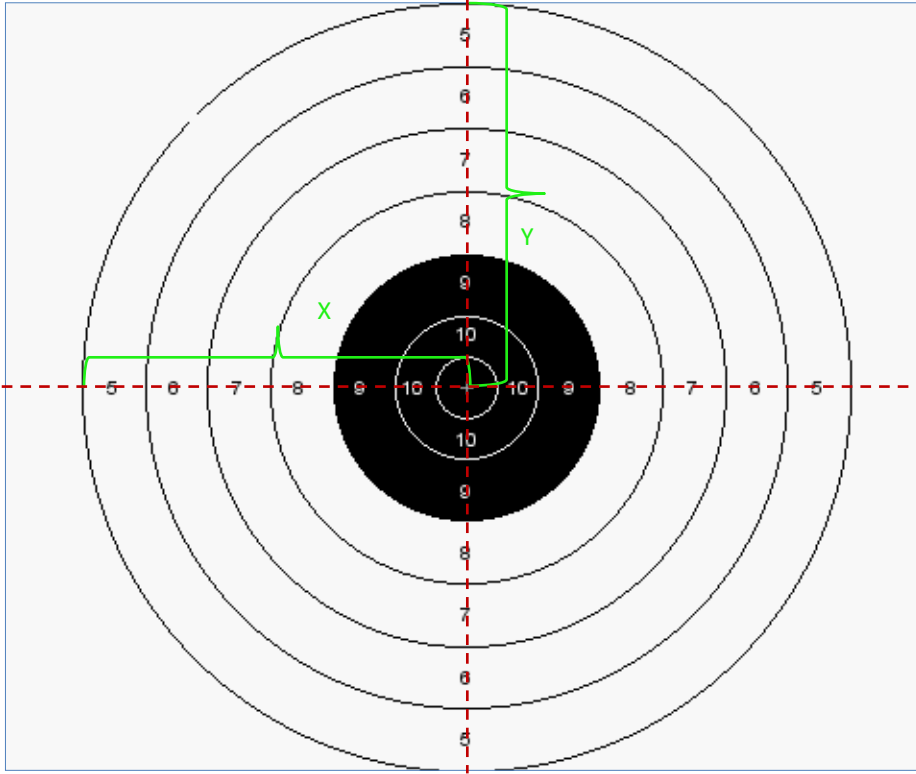

Diameter (mm)	Value
76,2	X
177,8	10
330,2	9
482,6	8
635	7
787,4	6
939,8	5

X	469,9 mm
Y	469,9 mm

Zoom levels

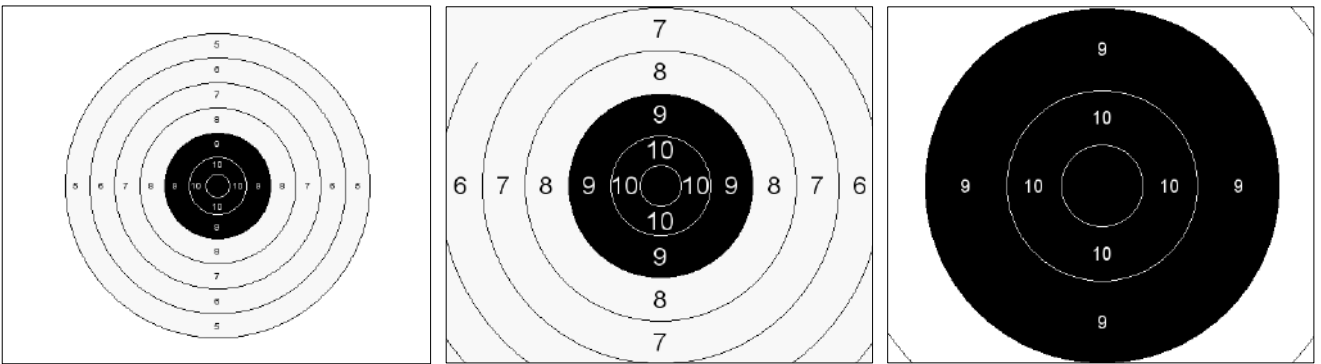

Technical data

Part No	735-0097-97-0369
Size	N/A
Gauge (default)	7,62 mm
Aiming mark diameter	330,2 mm
Manufacture	
Manufacture Part No	

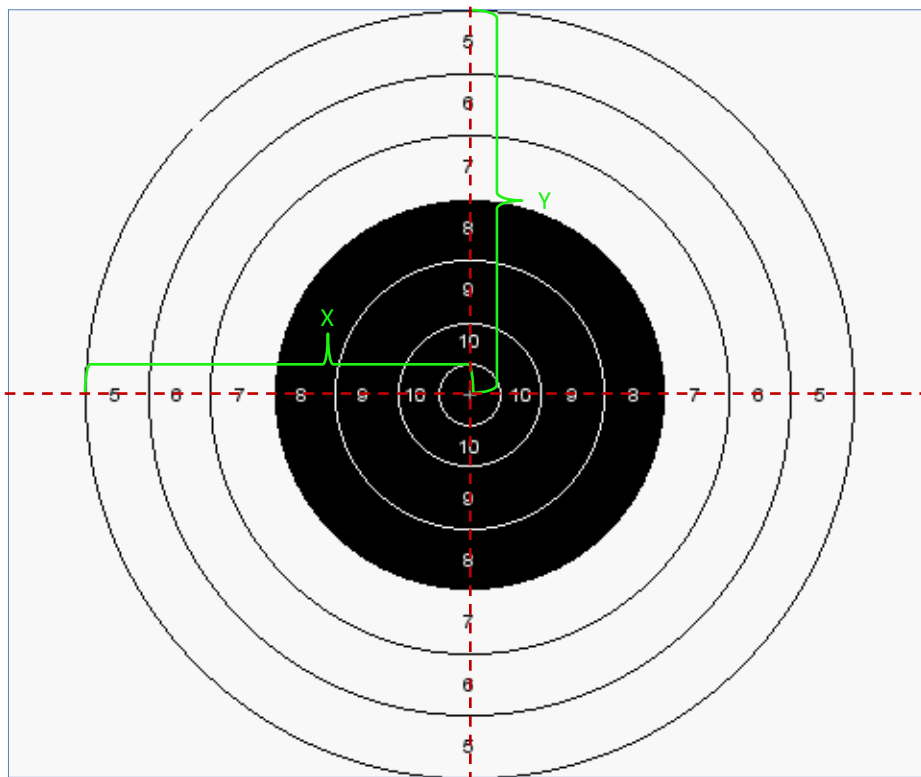

Diameter (mm)	Value
76,2	X
177,8	10
330,2	9
482,6	8
635	7
787,4	6
939,8	5

X	469,9 mm
Y	469,9 mm

Zoom levels

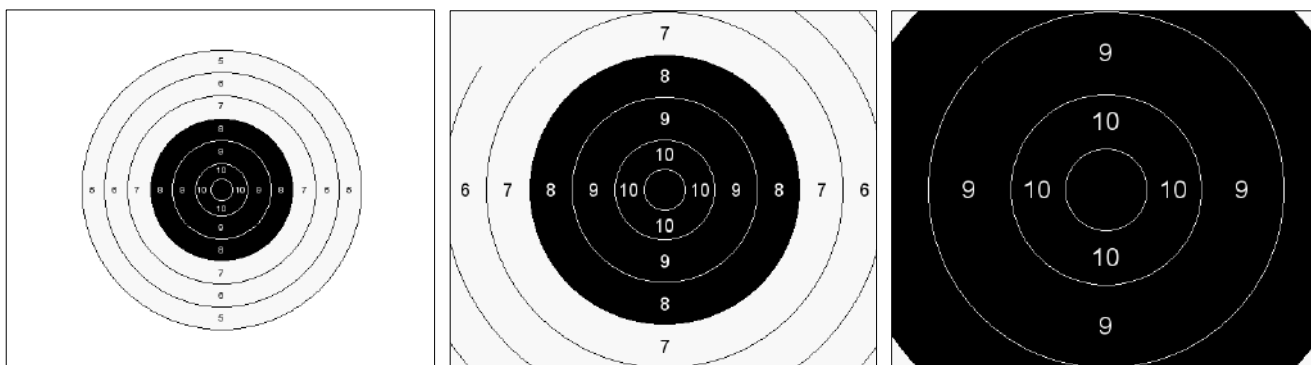

Technical data

Part No	735-0097-97-0370
Size	N/A
Gauge (default)	7,62 mm
Aiming mark diameter	482,6 mm
Manufacture	
Manufacture Part No	

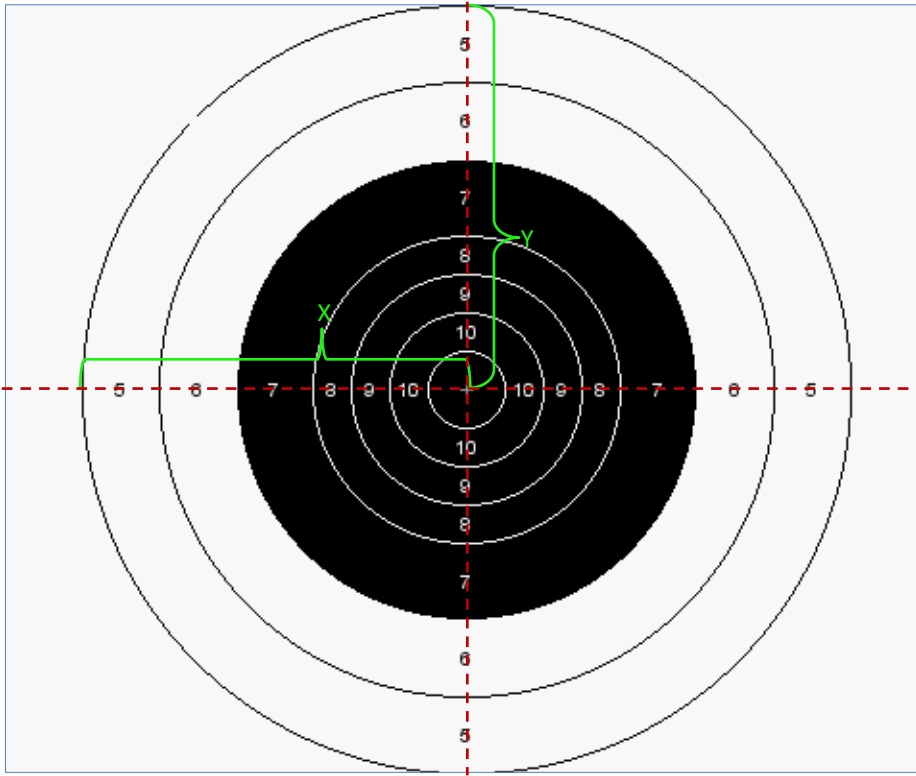

Diameter (mm)	Value
152,4	X
304,8	10
457,2	9
609,6	8
914,4	7
1219,2	6
1524	5

X	762 mm
Y	762 mm

Zoom levels

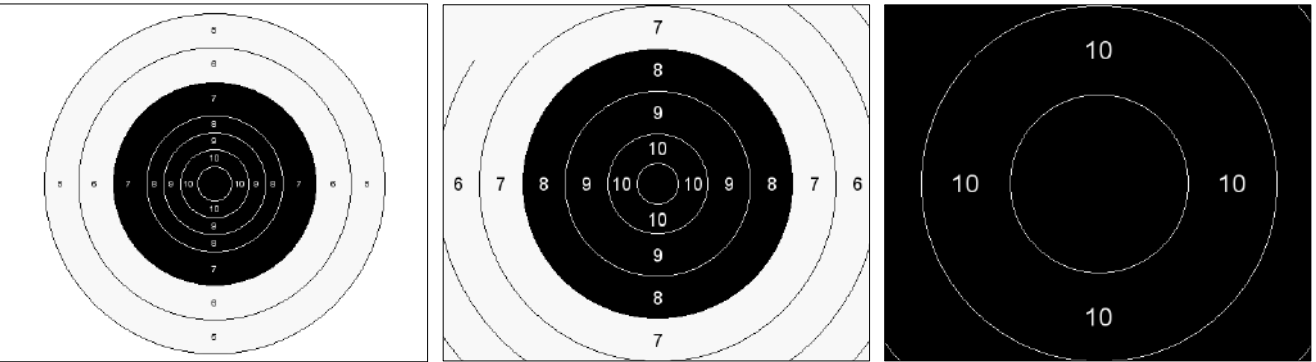

Technical data

Part No	735-0097-97-0371
Size	N/A
Gauge (default)	7,62 mm
Aiming mark diameter	914,4 mm
Manufacture	
Manufacture Part No	

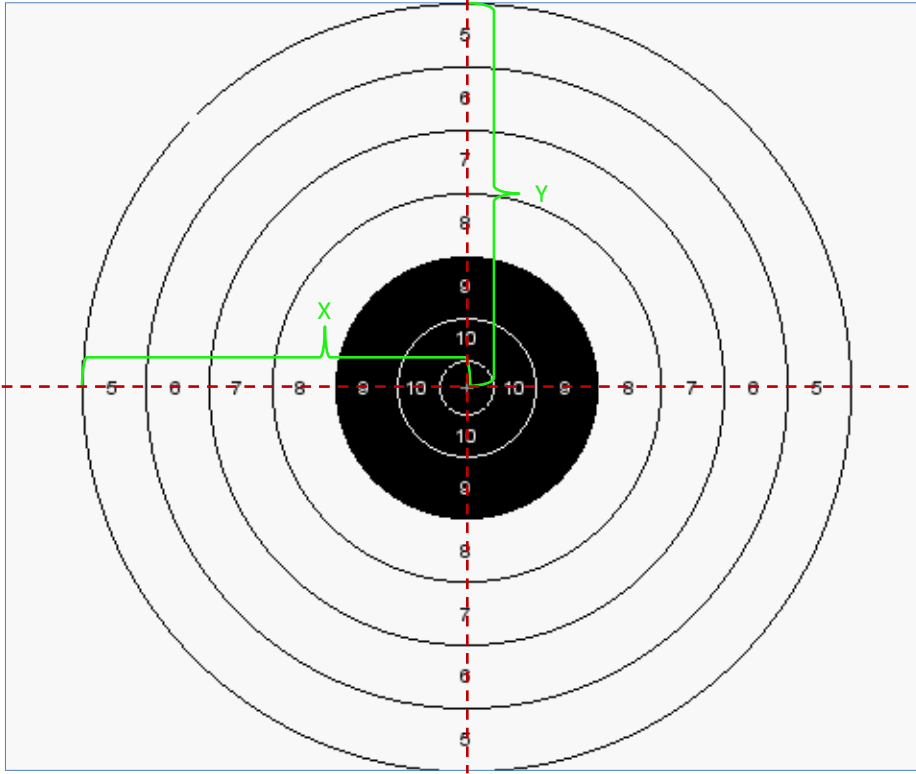

Diameter (mm)	Value
34,29	X
85,09	10
161,29	9
237,49	8
313,69	7
389,89	6
466,09	5

X	233,045 mm
Y	233,045 mm

Zoom levels

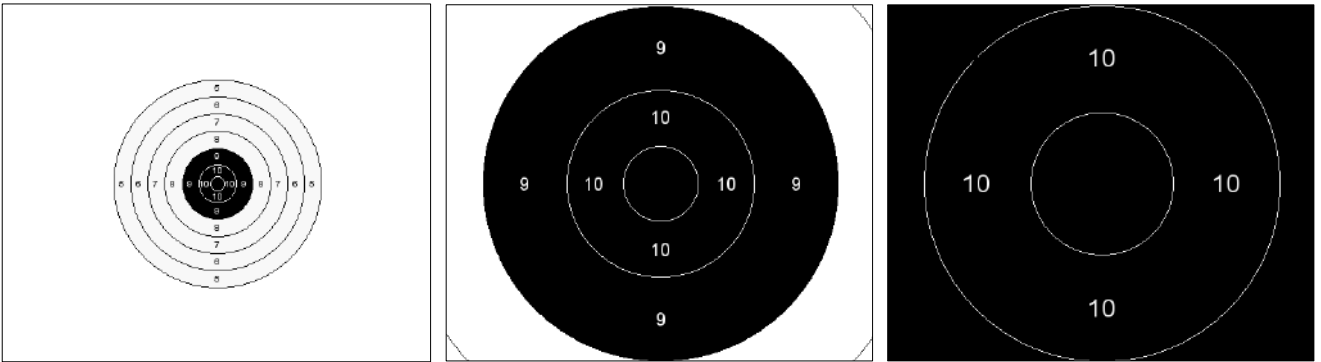

Technical data

Part No	735-0097-97-0372
Size	N/A
Gauge (default)	5,60 mm
Aiming mark diameter	161,29 mm
Manufacture	
Manufacture Part No	

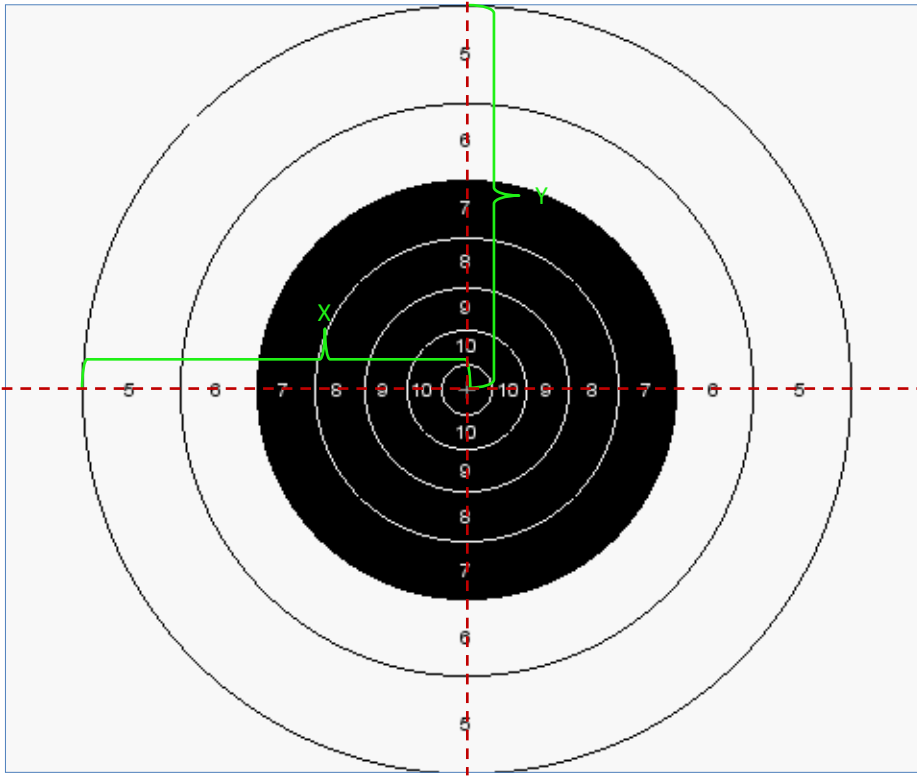

Diameter (mm)	Value
17	X
38,4	10
66	9
97	8
135,1	7
183,4	6
245,4	5

X	122,7 mm
Y	122,7 mm

Zoom levels

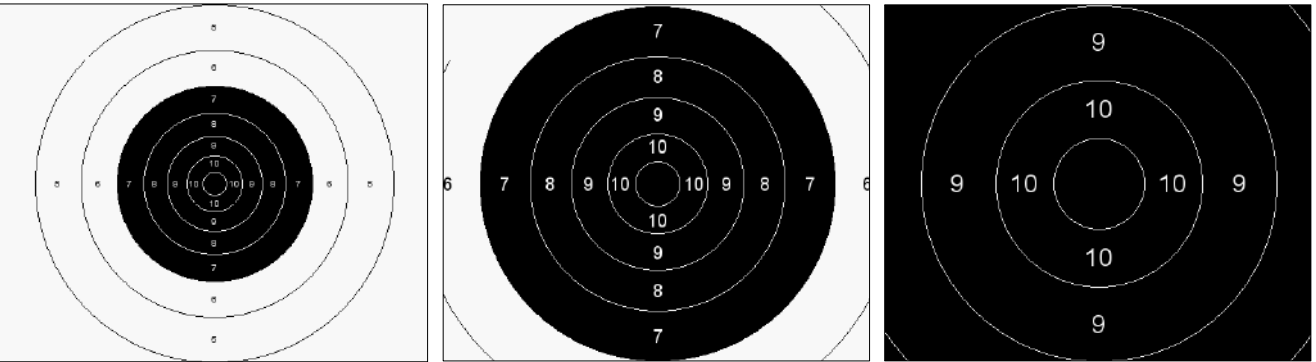

Technical data

Part No	735-0097-97-0373
Size	N/A
Gauge (default)	5,60 mm
Aiming mark diameter	135,1 mm
Manufacture	
Manufacture Part No	

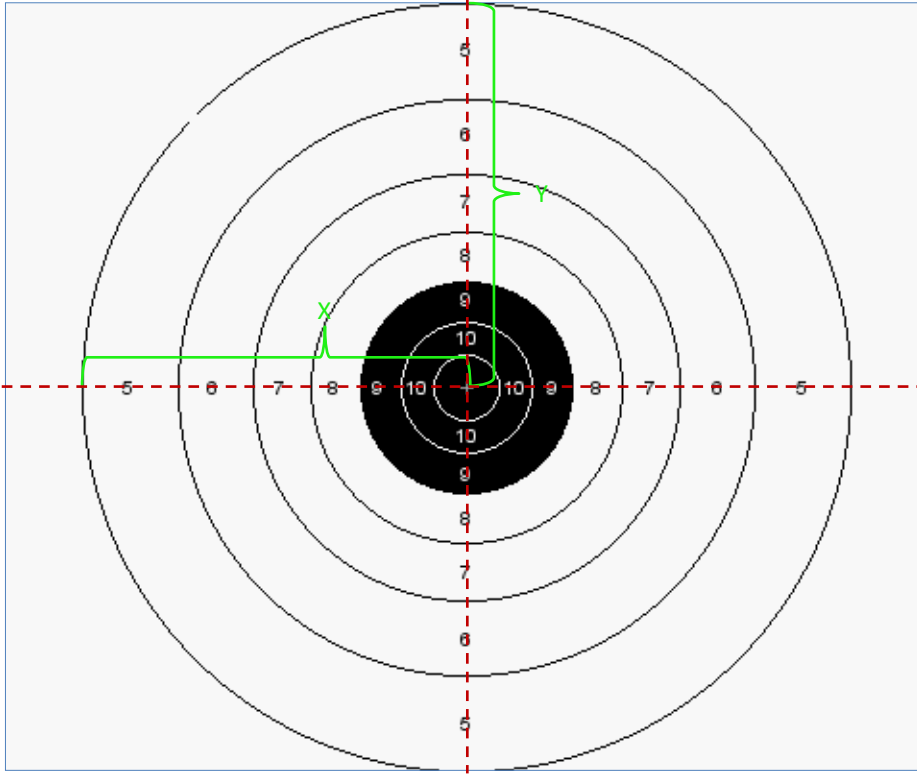

Diameter (mm)	Value
43,1	X
85,3	10
140,7	9
203,2	8
279,4	7
375,9	6
499,9	5

X	249,95 mm
Y	249,95 mm

Zoom levels

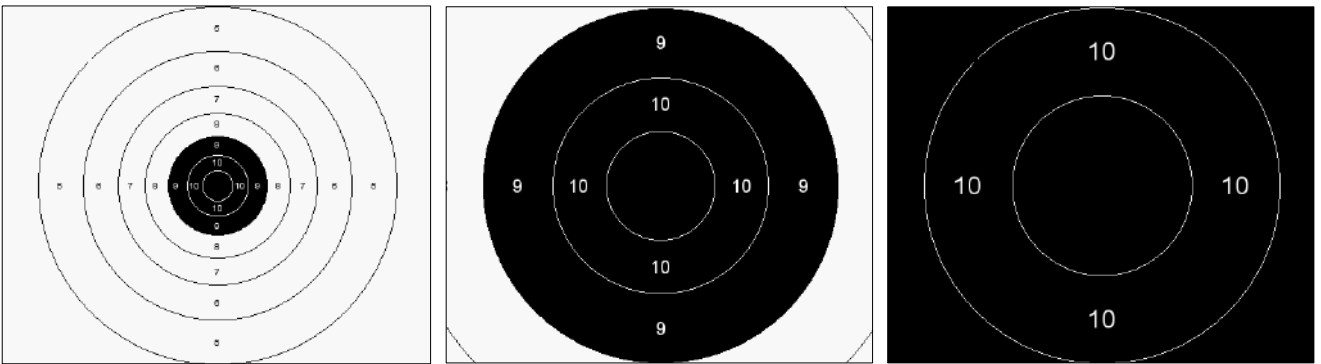

Technical data

Part No	735-0097-97-0374
Size	N/A
Gauge (default)	5,60 mm
Aiming mark diameter	140,7 mm
Manufacture	
Manufacture Part No	

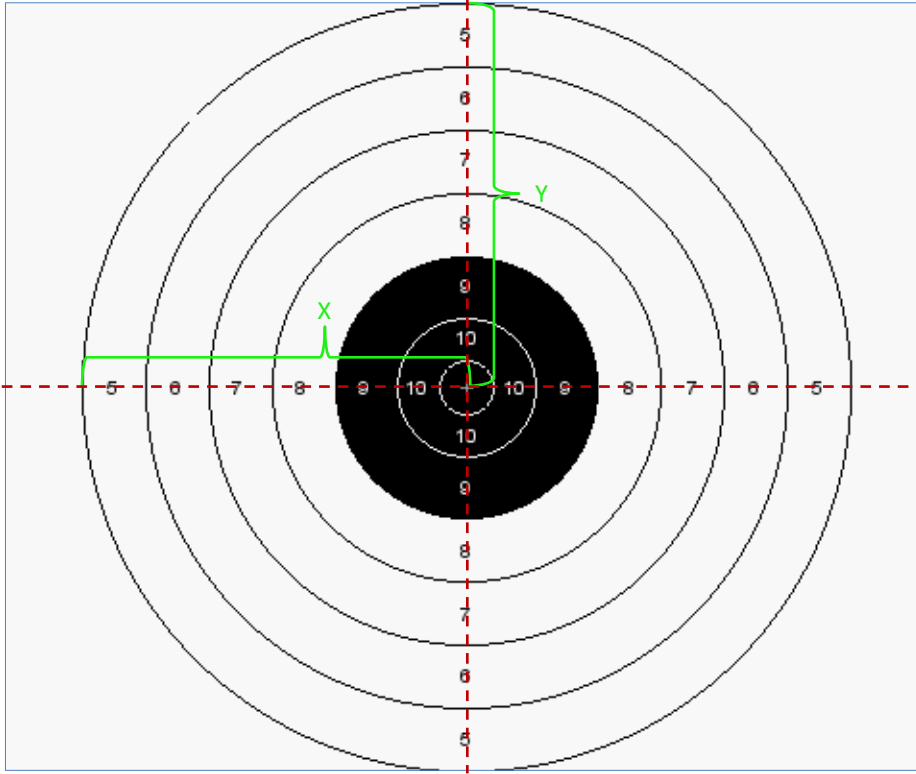

Diameter (mm)	Value
34,29	X
85,09	10
161,29	9
237,49	8
313,69	7
389,89	6
466,09	5

X	233,045 mm
Y	233,045 mm

Zoom levels

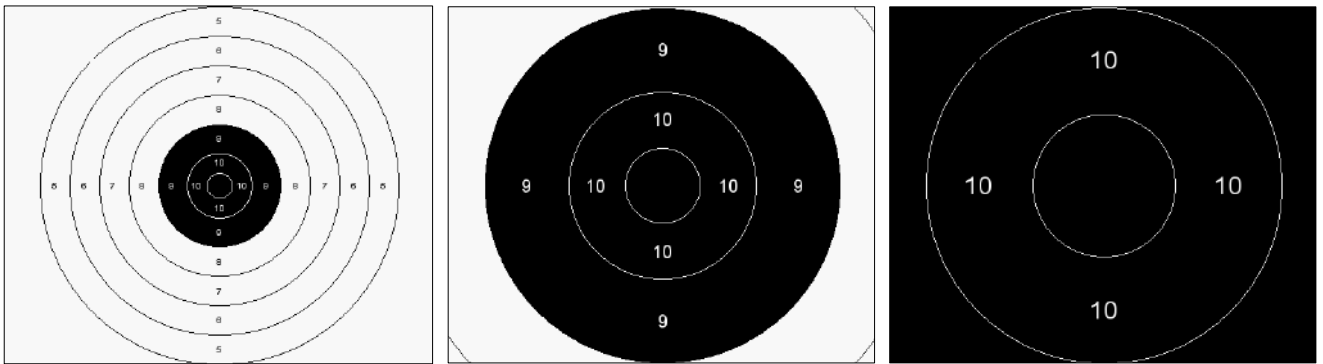

Technical data

Part No	735-0097-97-0375
Size	2 kB
Gauge (default)	7,82 mm
Aiming mark diameter	161,29 mm
Manufacture	
Manufacture Part No	

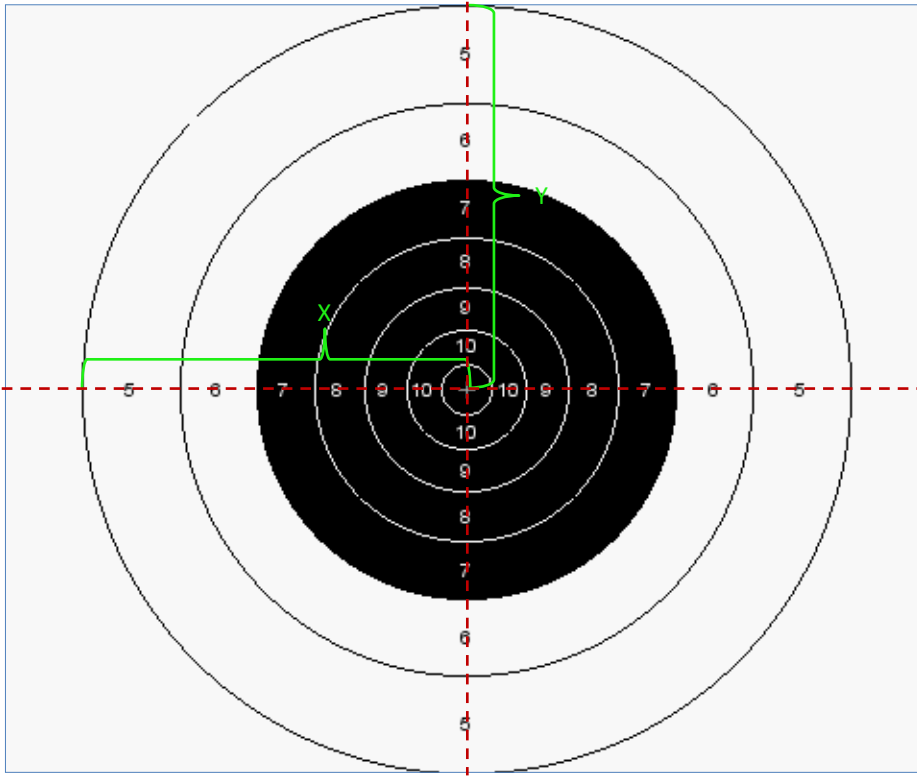

Diameter (mm)	Value
17	X
38,4	10
66	9
97	8
135,1	7
183,4	6
245,4	5

X	122,7 mm
Y	122,7 mm

Zoom levels

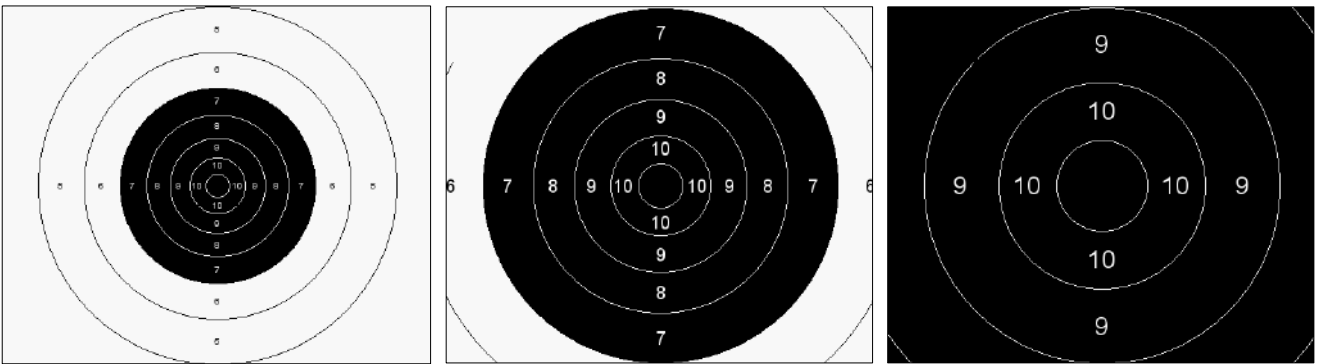

Technical data

Part No	735-0097-97-0376
Size	
Gauge (default)	11,43 mm
Aiming mark diameter	135,1 mm
Manufacture	
Manufacture Part No	

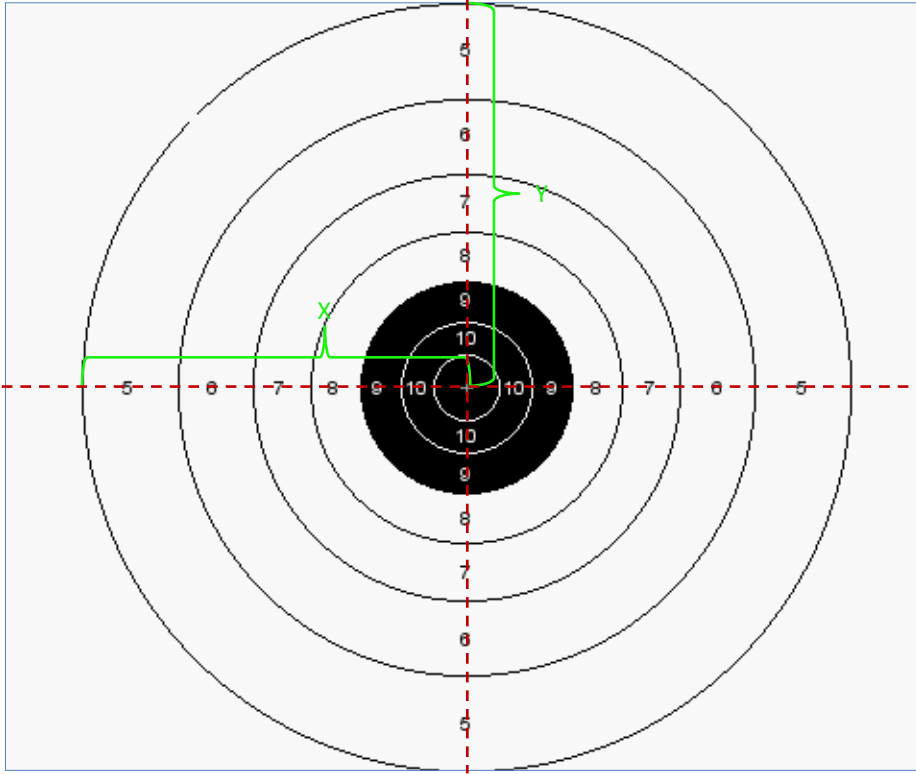

Diameter (mm)	Value
43,1	X
85,3	10
140,7	9
203,2	8
279,4	7
375,9	6
499,9	5

X	249,95 mm
Y	249,95 mm

Zoom levels

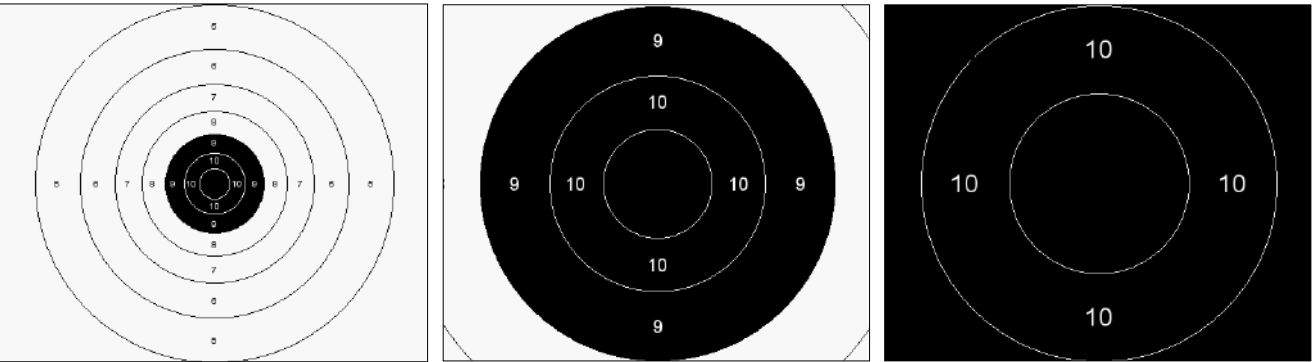

Technical data

Part No	735-0097-97-0377
Size	2 kB
Gauge (default)	11,43 mm
Aiming mark diameter	140,7 mm
Manufacture	
Manufacture Part No	

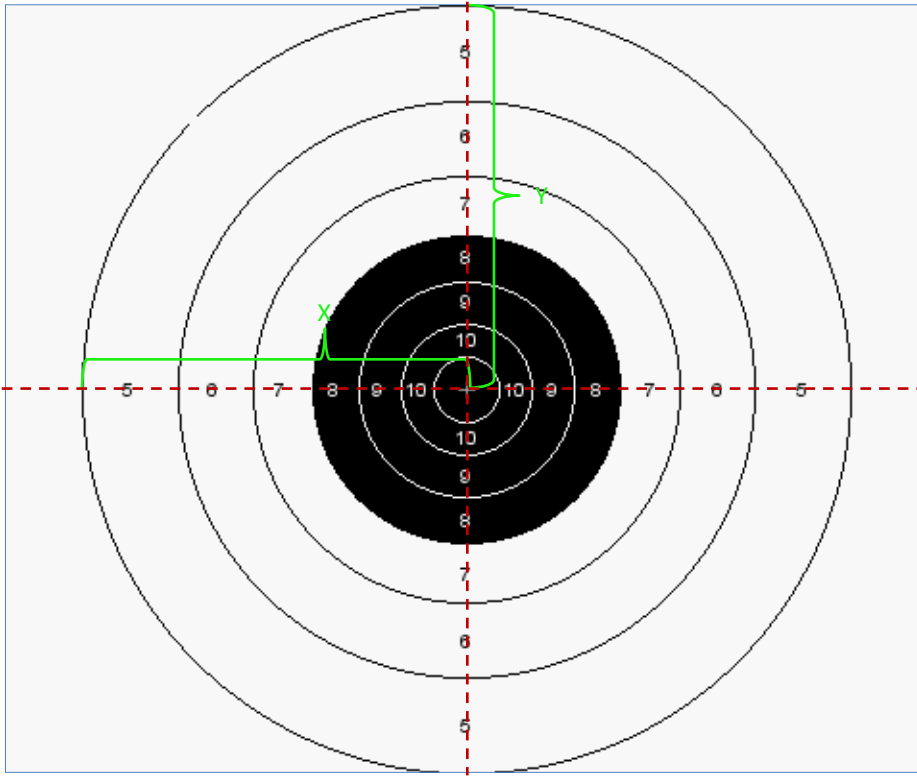

Diameter (mm)	Value
43,1	X
85,3	10
140,7	9
203,2	8
279,4	7
375,9	6
499,9	5

X	249,95 mm
Y	249,95 mm

Zoom levels



Technical data

Part No	735-0097-97-0378
Size	N/A
Gauge (default)	5,6 mm
Aiming mark diameter	203,2 mm
Manufacture	
Manufacture Part No	

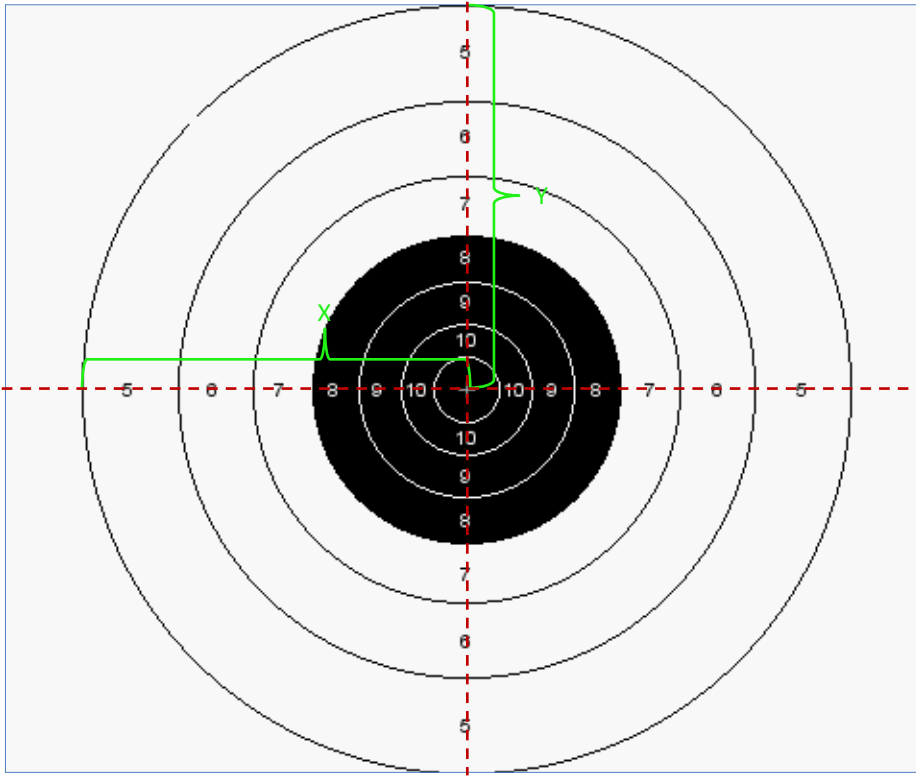

Diameter (mm)	Value
43,1	X
85,3	10
140,7	9
203,2	8
279,4	7
375,9	6
499,9	5

X	249,95 mm
Y	249,95 mm

Zoom levels



Technical data

Part No	735-0097-97-0379
Size	2 kB
Gauge (default)	11,43 mm
Aiming mark diameter	203,2 mm
Manufacture	
Manufacture Part No	

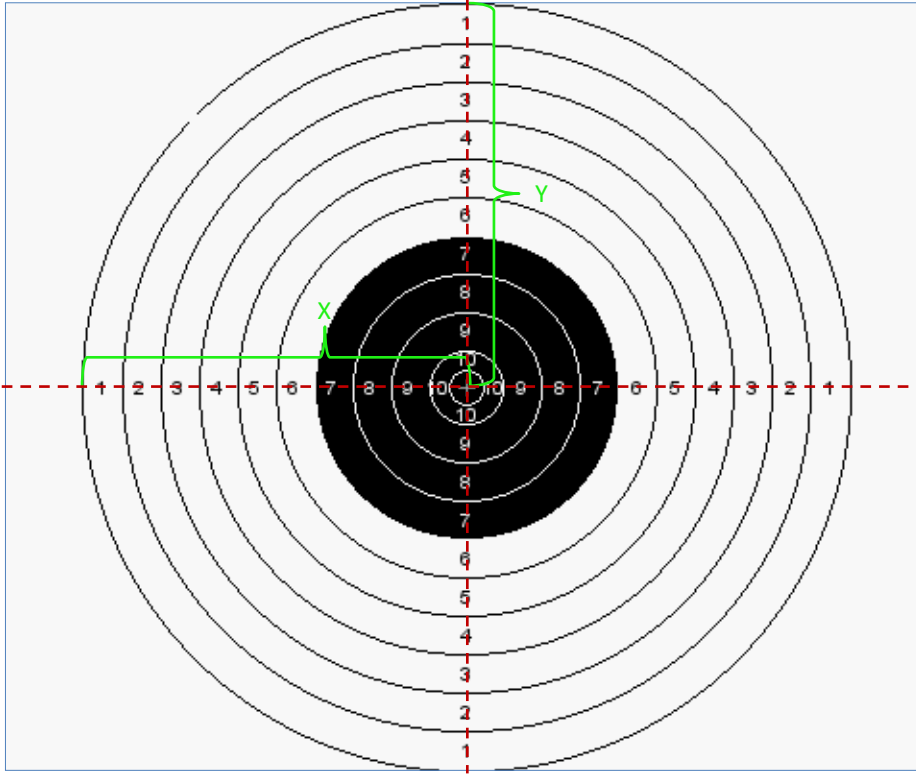

Diameter (mm)	Value
20,8	X
45,2	10
90,9	9
136,7	8
182,4	7
228,1	6
273,8	5
319,5	4
365,3	3
411	2
456,7	1

X	228,35 mm
Y	228,35 mm

Zoom levels

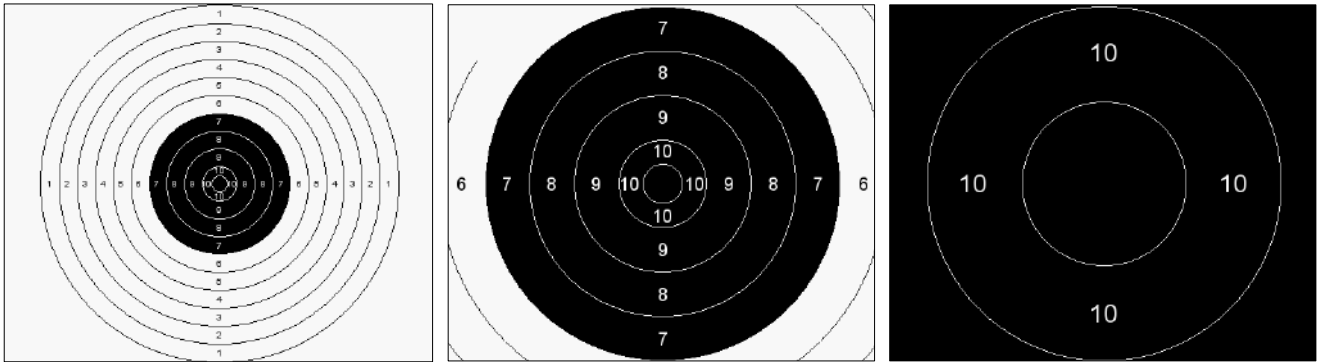

Technical data

Part No	735-0097-97-0380
Size	N/A
Gauge (default)	5,6 mm
Aiming mark diameter	182,4 mm
Manufacture	
Manufacture Part No	

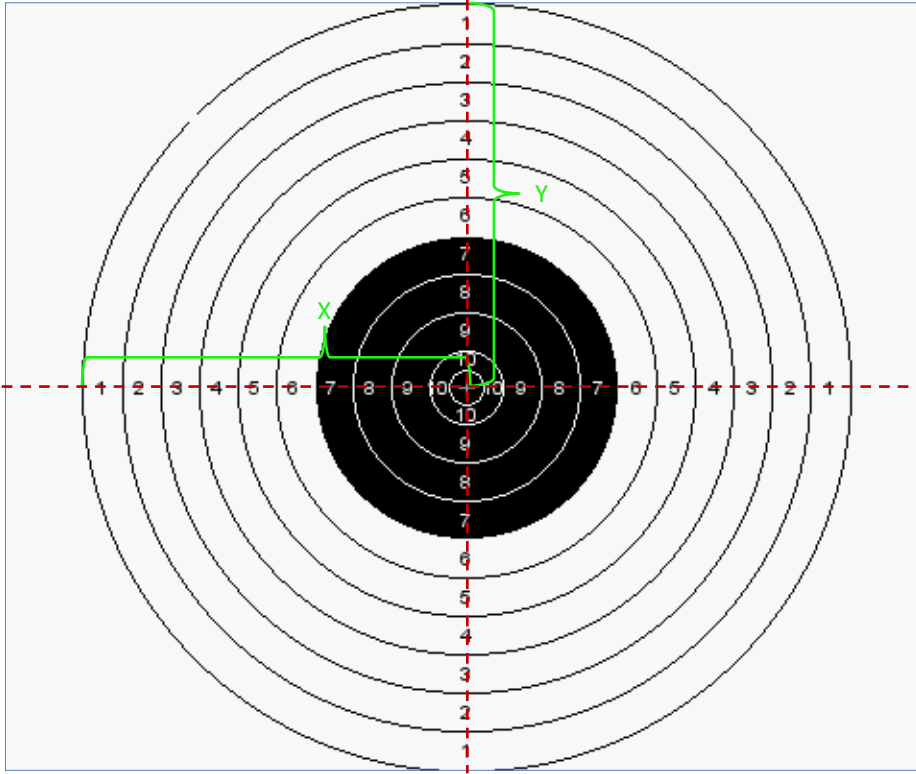

Diameter (mm)	Value
20,8	X
45,2	10
90,9	9
136,7	8
182,4	7
228,1	6
273,8	5
319,5	4
365,3	3
411	2
456,7	1

X	228,35 mm
Y	228,35 mm

Zoom levels

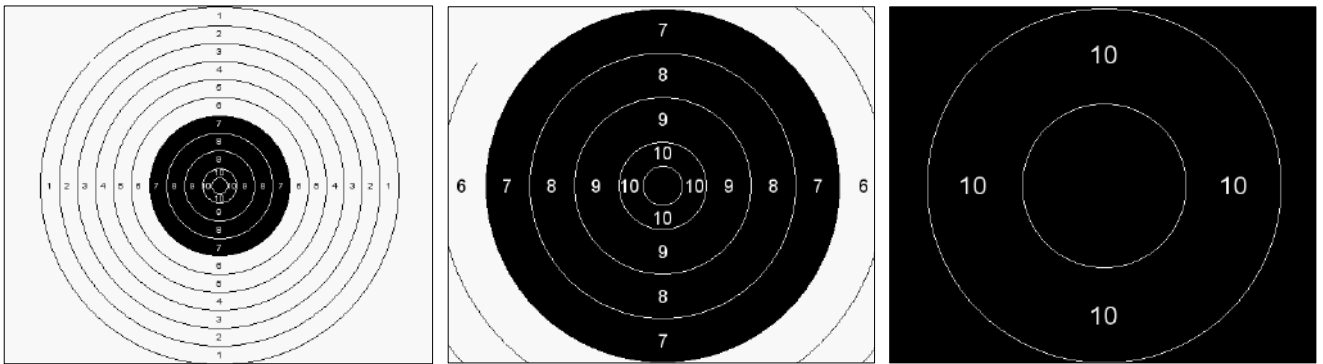

Technical data

Part No	735-0097-97-0381
Size	2 kB
Gauge (default)	11,43 mm
Aiming mark diameter	182,4 mm
Manufacture	
Manufacture Part No	

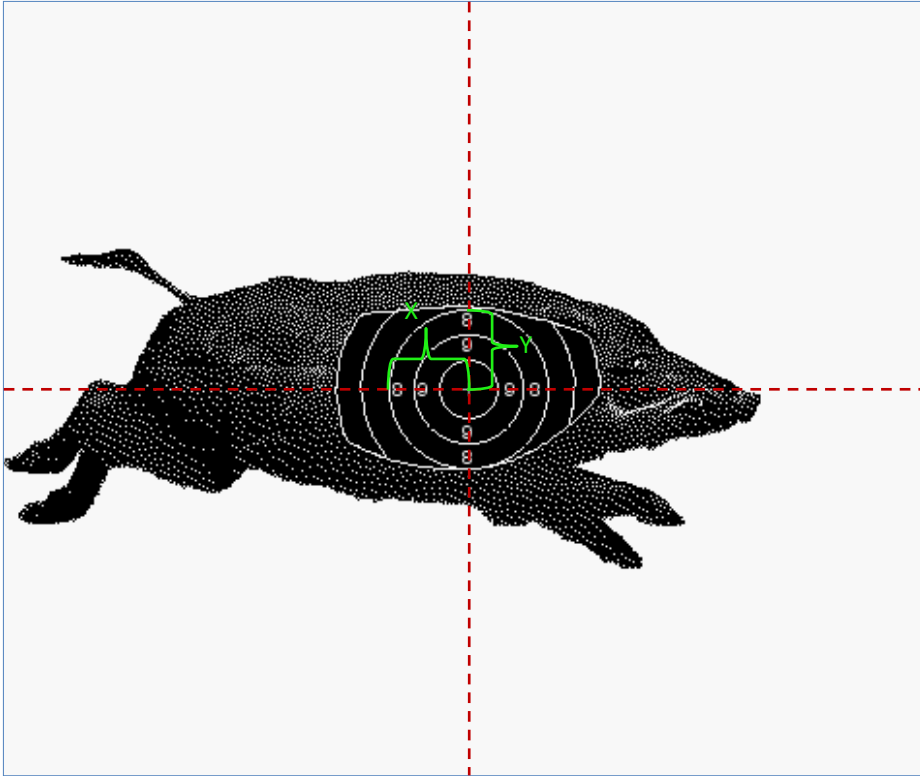

Diameter (mm)	Value
100	X
185	9
270	8

X	135 mm
Y	135 mm

Zoom levels

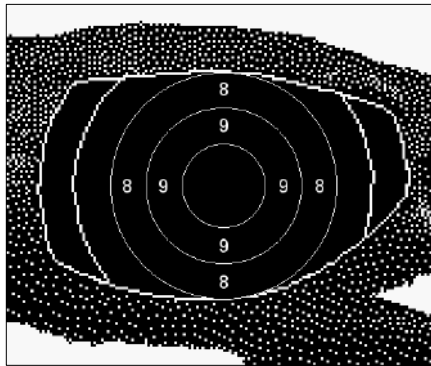
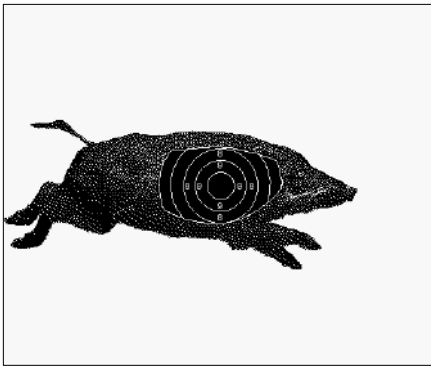

Technical data

Part No	735-0097-97-0383
Size	39 kB
Gauge (default)	8 mm
Aiming mark diameter	270 mm
Manufacture	
Manufacture Part No	

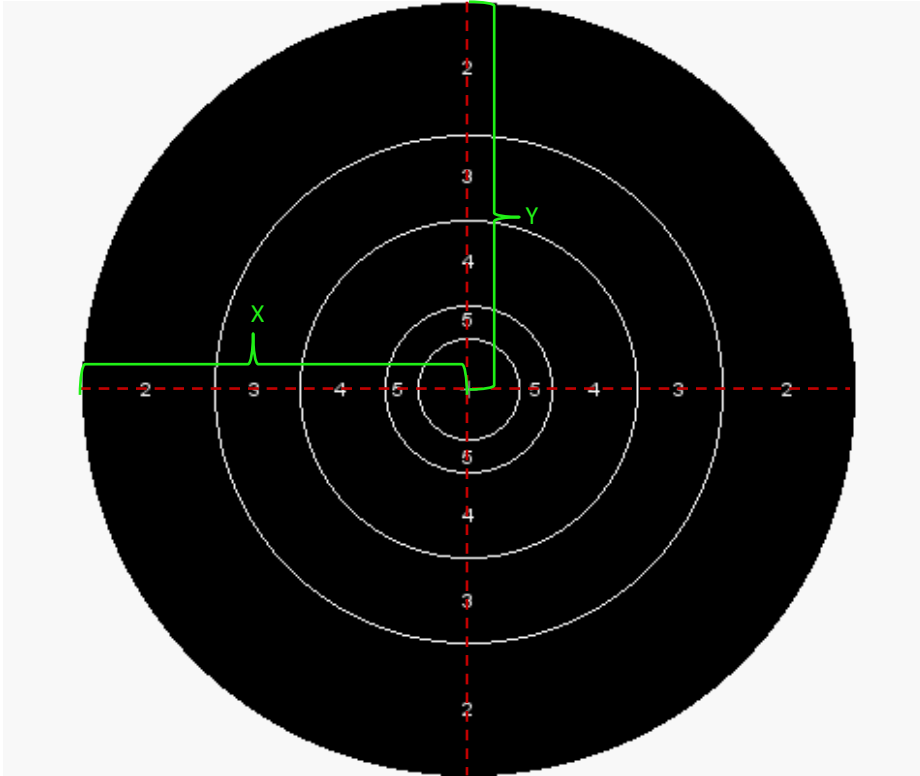

Diameter (mm)	Value
13,3	V
22,3	5
44,5	4
66,7	3
101,6	2

X	101,6 mm
Y	101,6 mm

Zoom levels

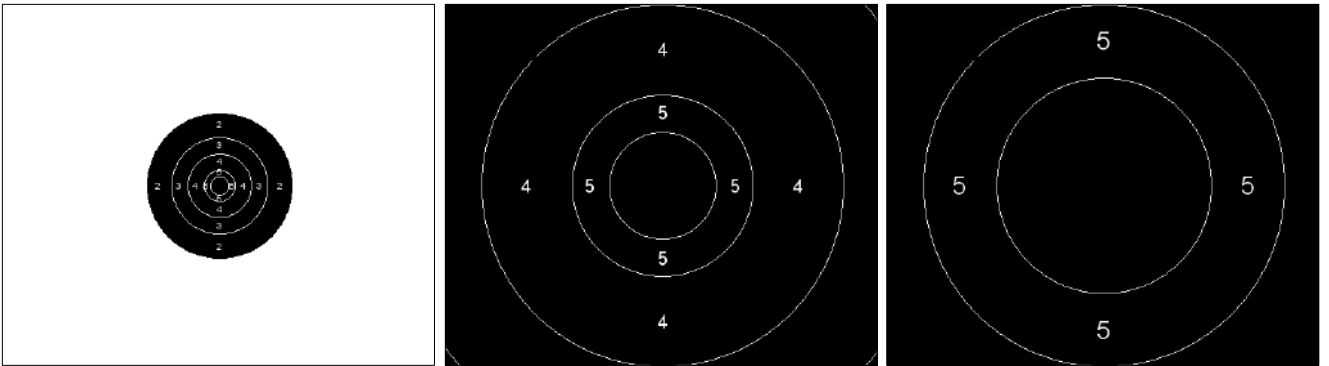

Technical data

Part No	735-0097-97-0384
Size	2 kB
Gauge (default)	8 mm
Aiming mark diameter	203,2 mm
Manufacture	
Manufacture Part No	

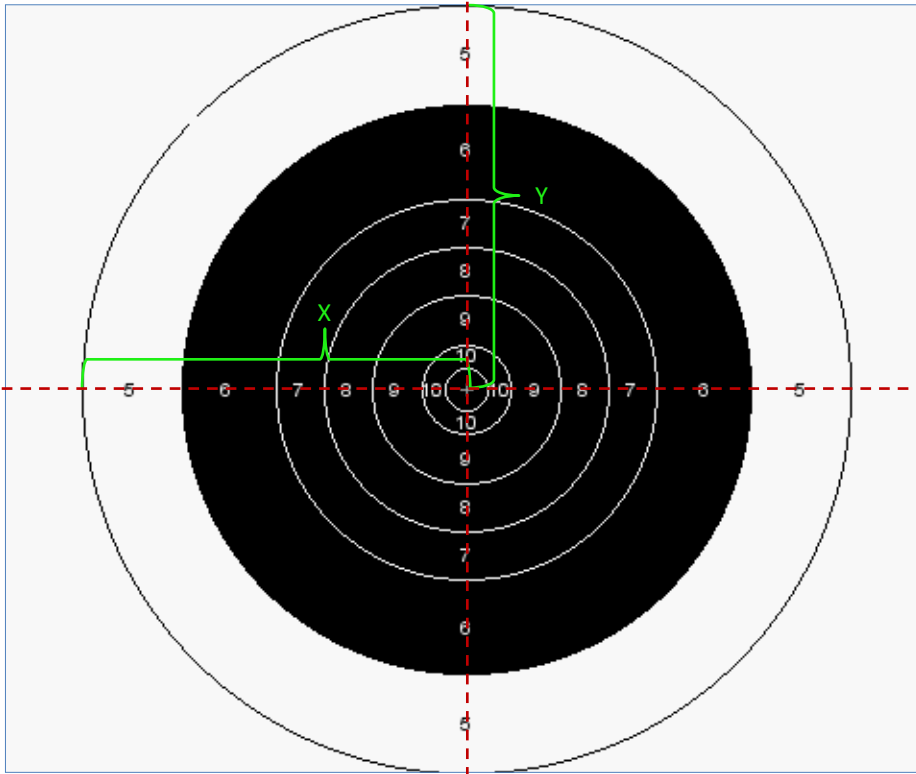

Diameter (mm)	Value
36,068	X
72,39	10
148,59	9
224,79	8
300,99	7
453,39	6
605,79	5

X	302,895 mm
Y	302,895 mm

Zoom levels

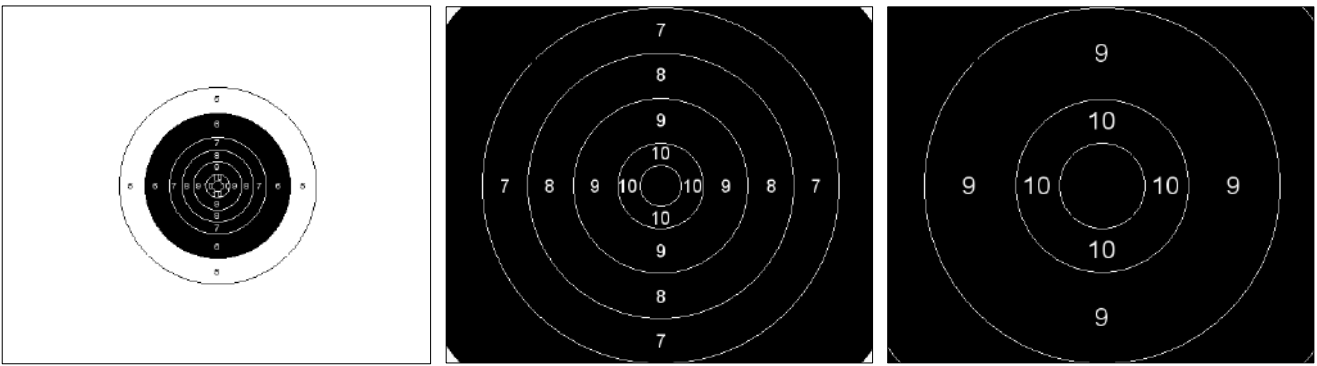

Technical data

Part No	735-0097-97-0385
Size	N/A
Gauge (default)	7,82 mm
Aiming mark diameter	453,39 mm
Manufacture	
Manufacture Part No	

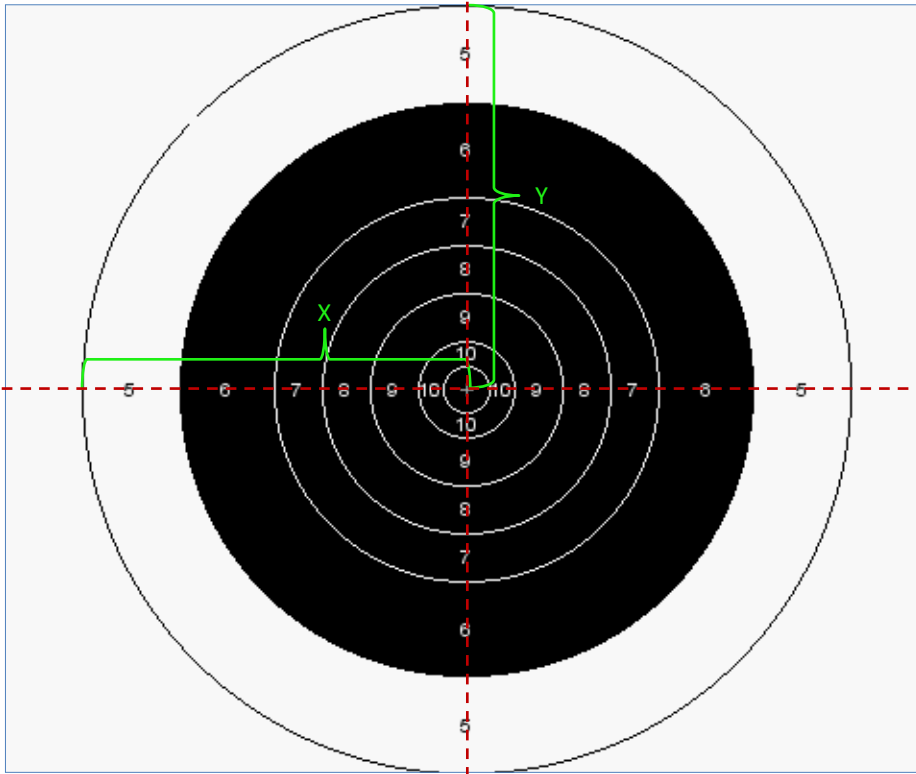

Diameter (mm)	Value
76,2	X
152,4	10
304,8	9
457,2	8
609,6	7
914,4	6
1219,2	5

X	609,6 mm
Y	609,6 mm

Zoom levels

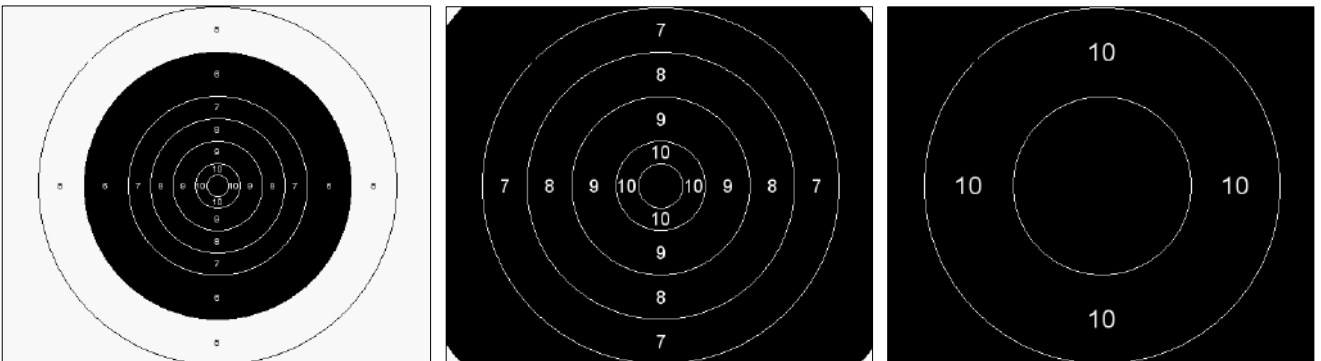

Technical data

Part No	735-0097-97-0386
Size	N/A
Gauge (default)	7,82 mm
Aiming mark diameter	914,4 mm
Manufacture	
Manufacture Part No	

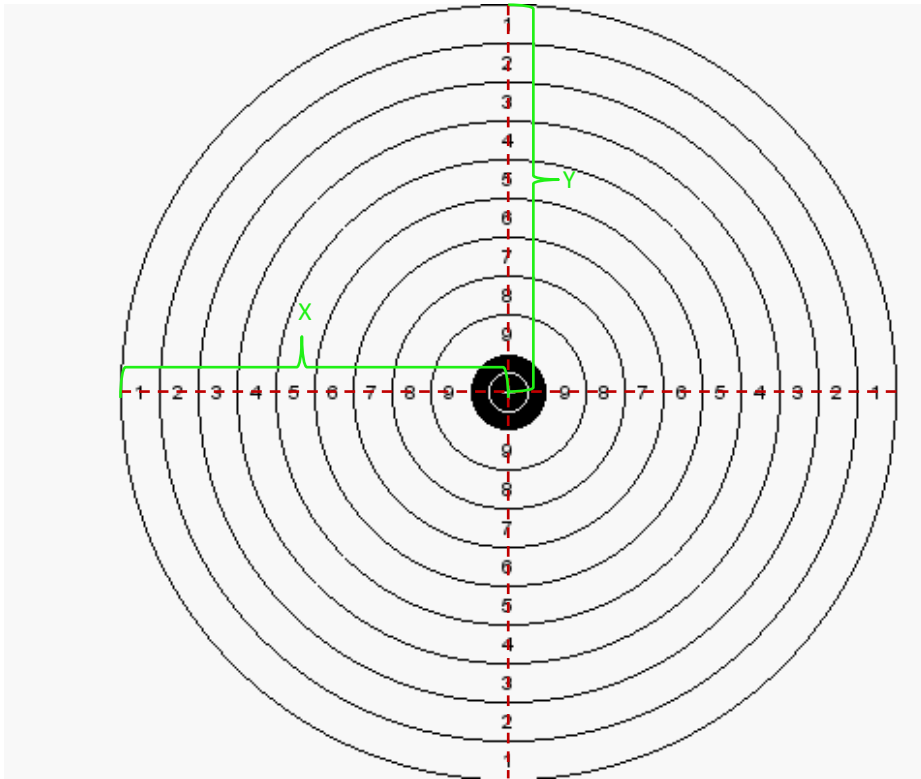

Diameter (mm)	Value
50	*
100	X
200	9
300	8
400	7
500	6
600	5
700	4
800	3
900	2
1000	1

X	500 mm
Y	500 mm

Zoom levels

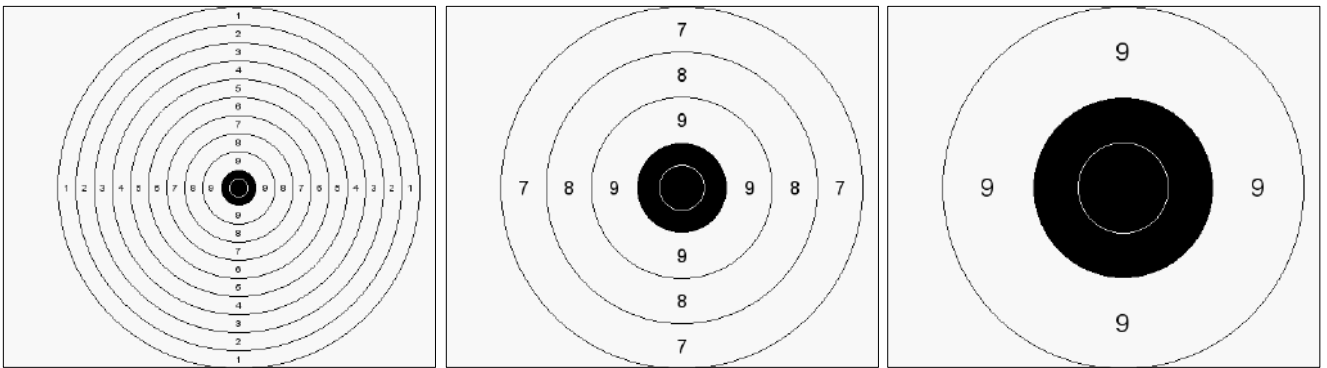

Technical data

Part No	735-0097-97-0389
Size	N/A
Gauge (default)	8 mm
Aiming mark diameter	100 mm
Manufacture	
Manufacture Part No	

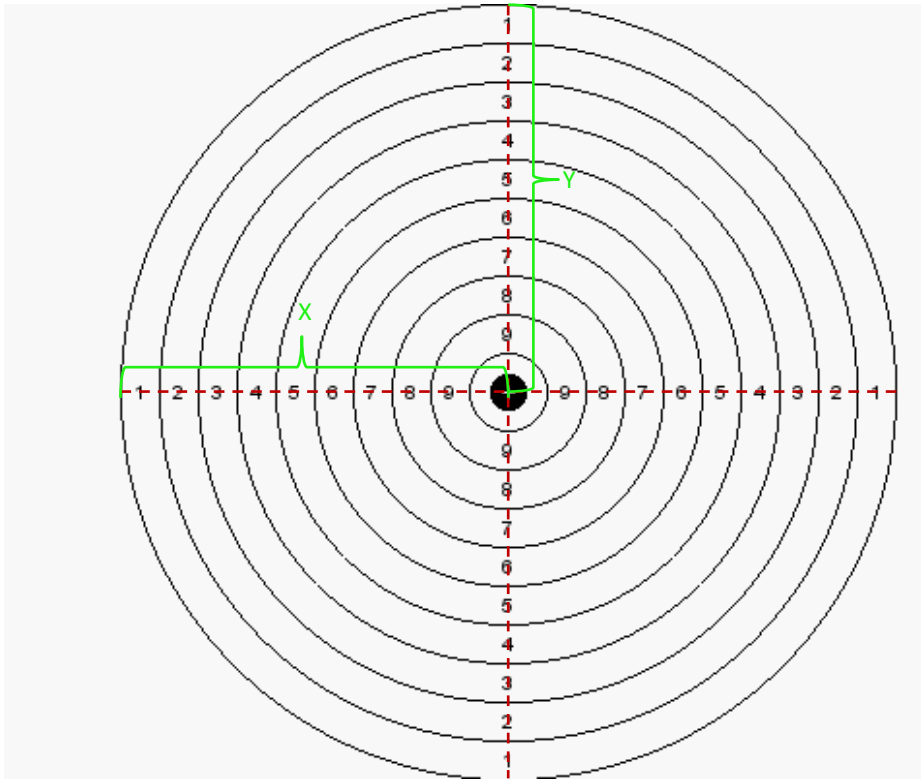

Diameter (mm)	Value
50	*
100	X
200	9
300	8
400	7
500	6
600	5
700	4
800	3
900	2
1000	1

X	500 mm
Y	500 mm

Zoom levels

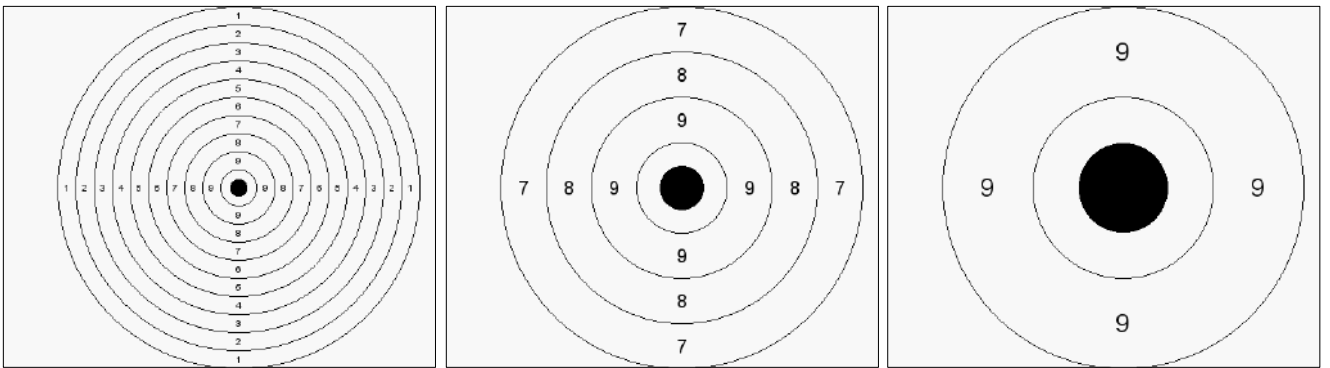

Technical data

Part No	735-0097-97-0390
Size	N/A
Gauge (default)	8 mm
Aiming mark diameter	50 mm
Manufacture	
Manufacture Part No	

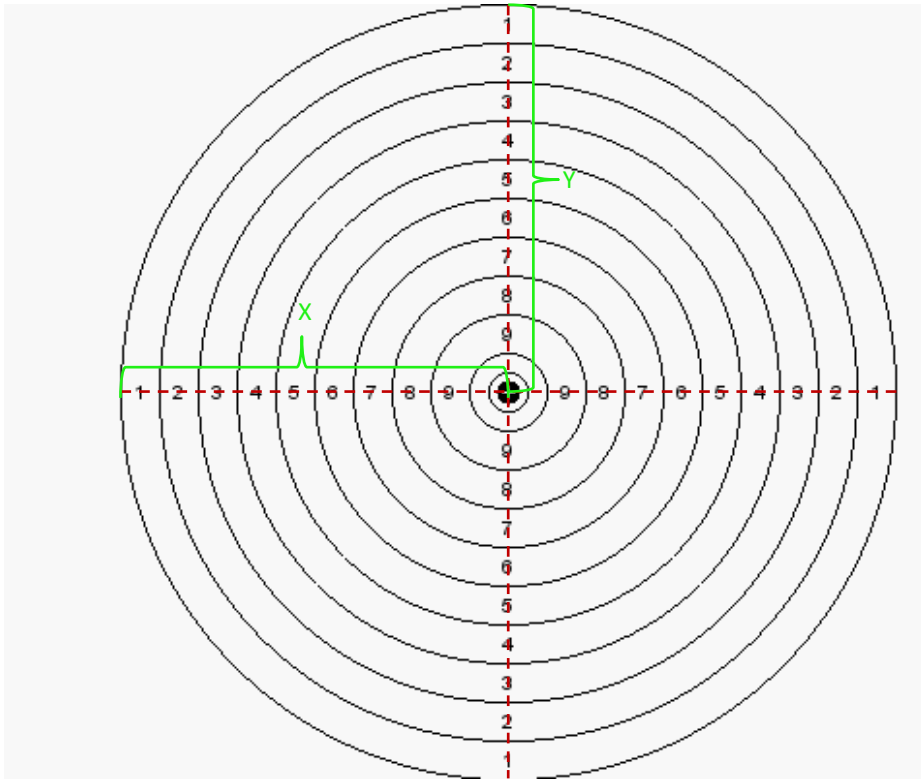

Diameter (mm)	Value
50	*
100	X
200	9
300	8
400	7
500	6
600	5
700	4
800	3
900	2
1000	1

X	500 mm
Y	500 mm

Zoom levels

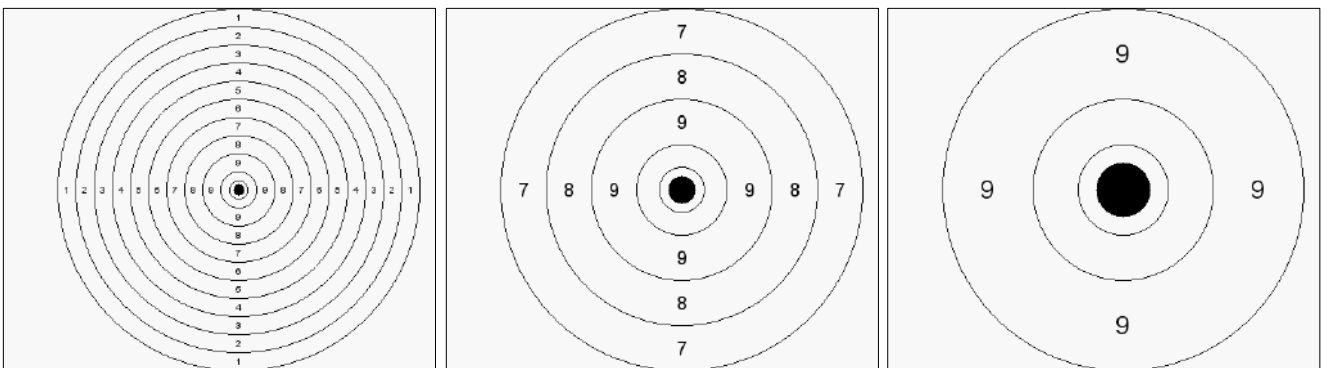

Technical data

Part No	735-0097-97-0391
Size	N/A
Gauge (default)	8 mm
Aiming mark diameter	30 mm
Manufacture	
Manufacture Part No	

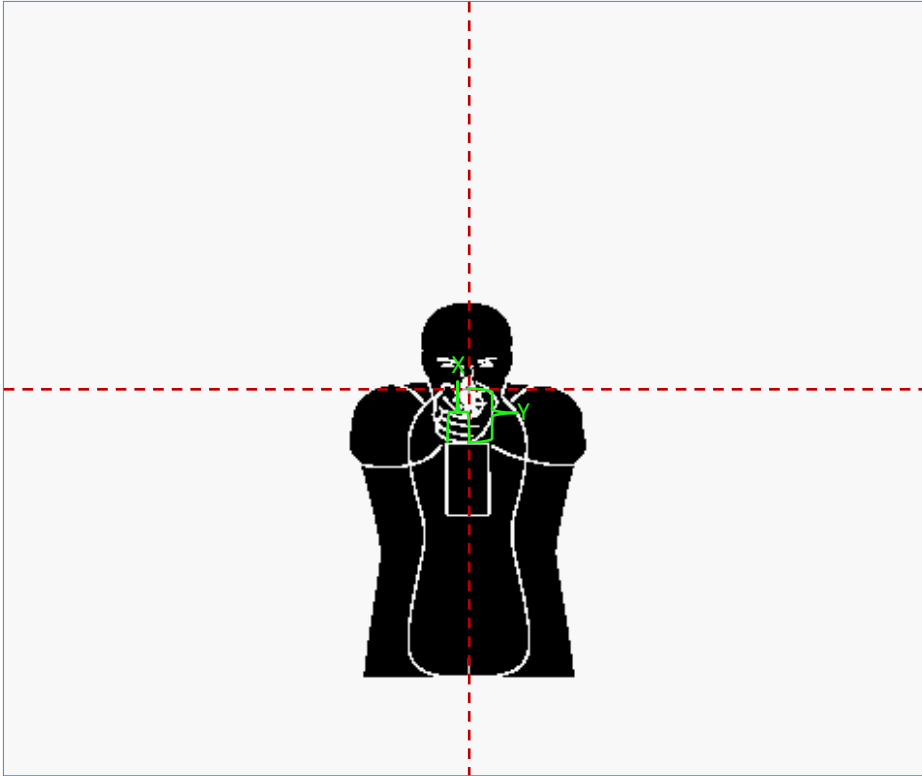

Diameter (mm)	Value
	3
	2
	1
	0

X	37,5 mm
Y	99 mm

Zoom levels

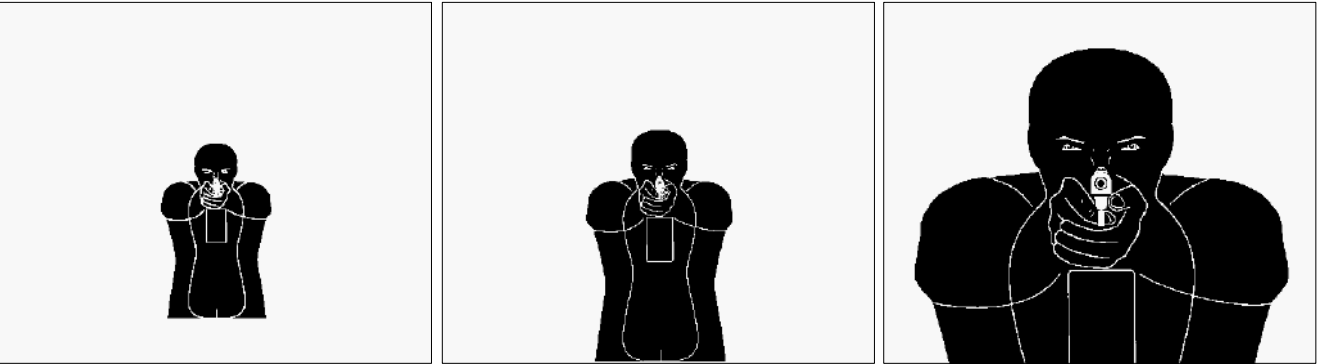

Technical data

Part No	735-0097-97-0392
Size	88 kB
Gauge (default)	9 mm
Aiming mark diameter	
Manufacture	
Manufacture Part No	

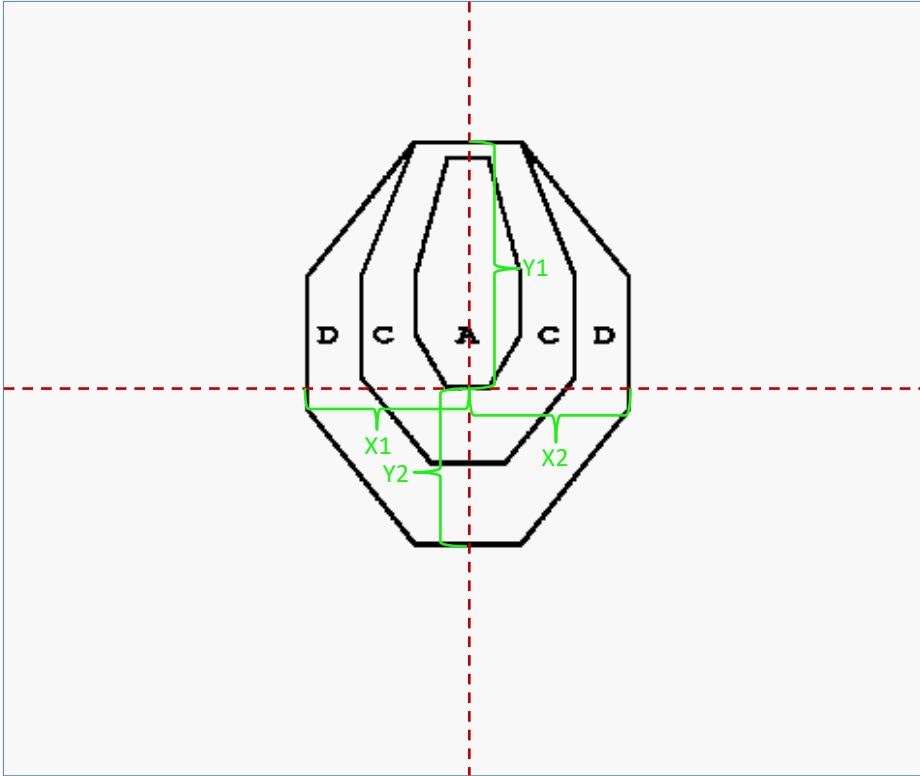

Diameter (mm)	Value
A	1
C	1
D	1
ROT	0

X1	150 mm	X2	150 mm
Y1	230 mm	Y2	145 mm

Zoom levels

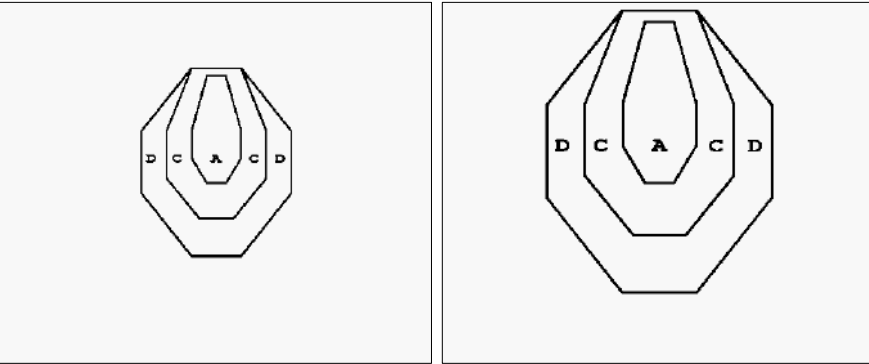

Technical data

Part No	735-0097-97-0393
Size	81 kB
Gauge (default)	8 mm
Aiming mark diameter	
Manufacture	
Manufacture Part No	

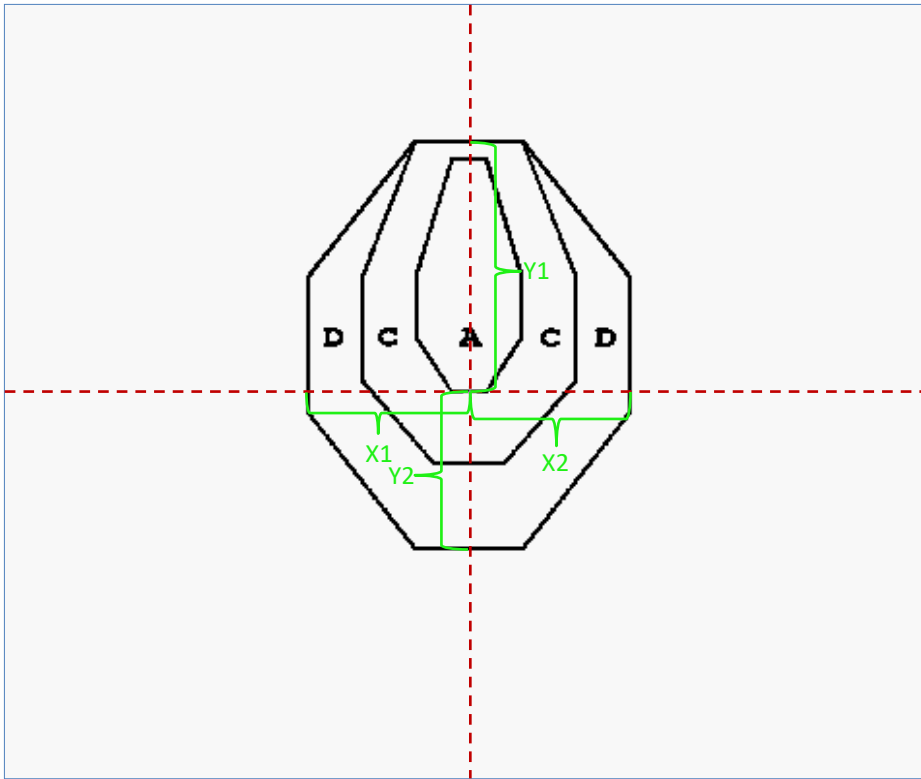

Diameter (mm)	Value
A	1
C	1
D	1
ROT	0

X1	225 mm	X2	225 mm
Y1	350 mm	Y2	220 mm

Zoom levels

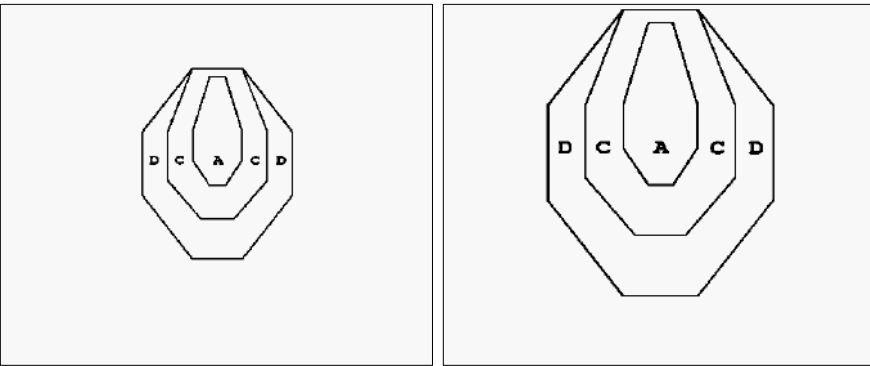

Technical data

Part No	735-0097-97-0394
Size	93 kB
Gauge (default)	8 mm
Aiming mark diameter	
Manufacture	
Manufacture Part No	

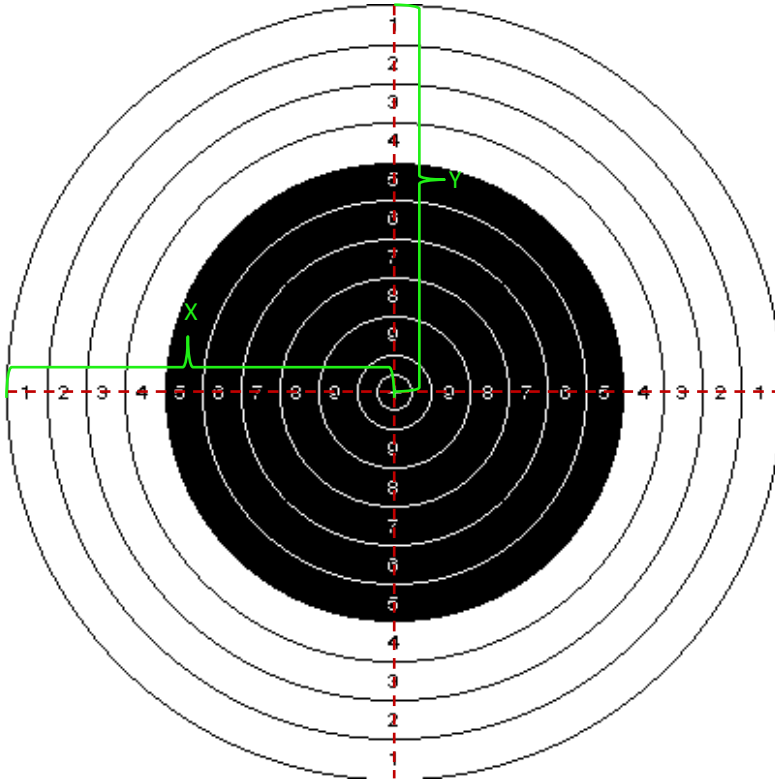

Diameter (mm)	Value
30,67	*
64,00	X
130,67	9
197,33	8
264,00	7
330,67	6
397,33	5
464,00	4
530,67	3
597,33	2
664,00	1

X	332 mm
Y	332 mm

Zoom levels

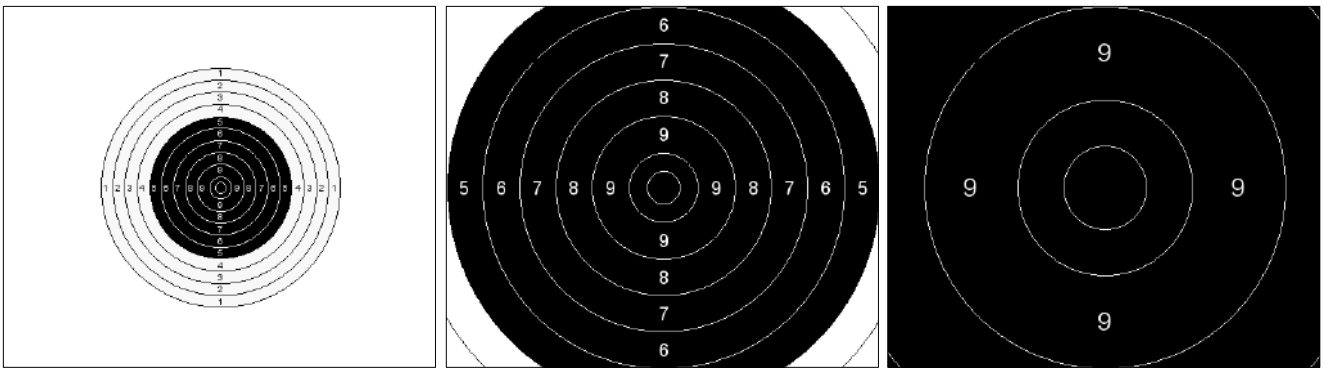

Technical data

Part No	735-0097-97-0399
Size	N/A
Gauge (default)	8 mm
Aiming mark diameter	400 mm
Manufacture	
Manufacture Part No	

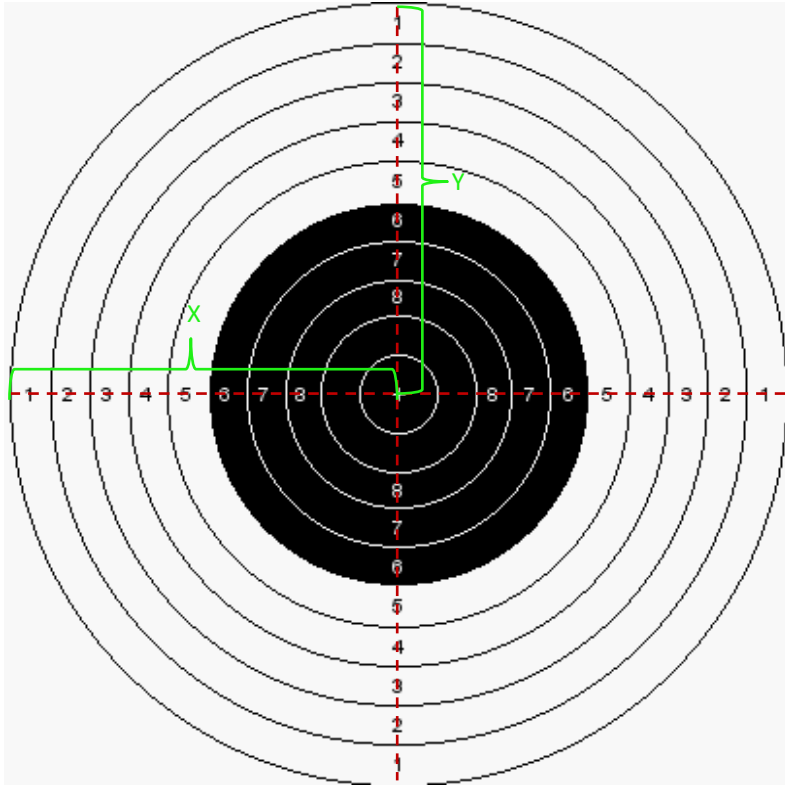

Diameter (mm)	Value
86,00	X
172,00	9
248,00	8
334,00	7
420,00	6
506,00	5
592,00	4
678,00	3
764,00	2
850,00	1

X	332 mm
Y	332 mm

Zoom levels

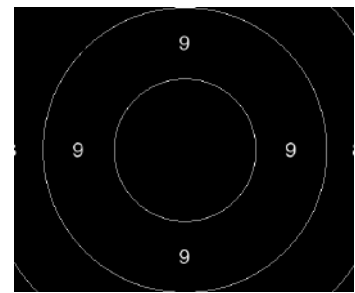
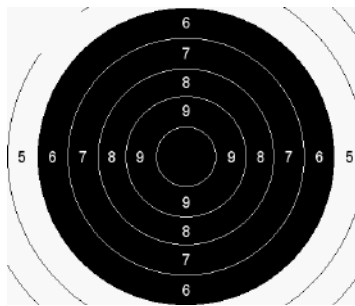
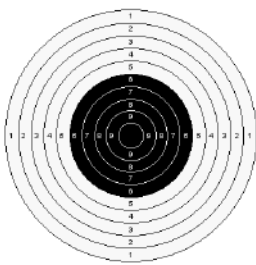

Technical data

Part No	735-0097-97-0400
Size	N/A
Gauge (default)	8 mm
Aiming mark diameter	420 mm
Manufacture	
Manufacture Part No	

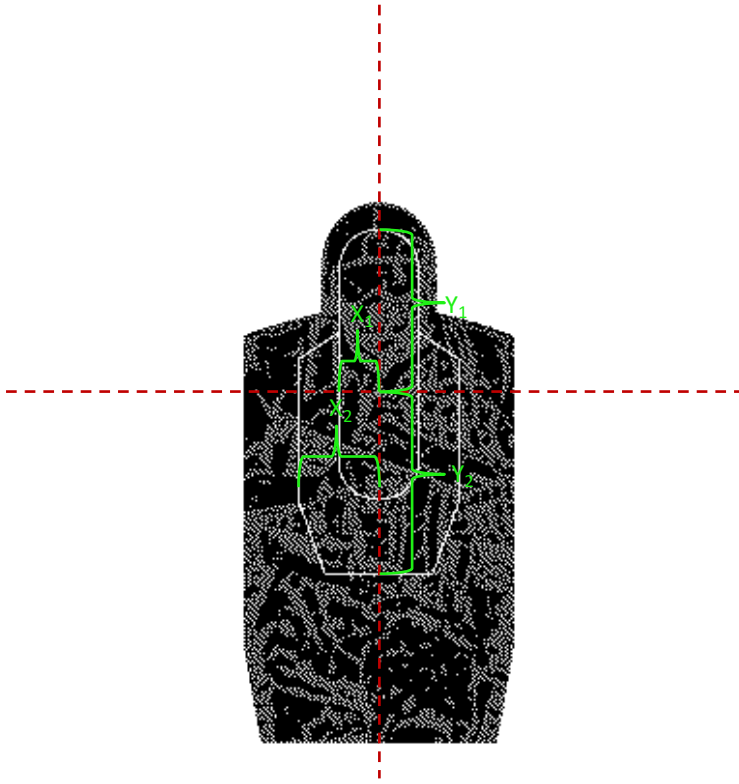

Diameter (mm)	Value
	5
	4
	2

X_1	75 mm	X_2	150 mm
Y_1	300 mm	Y_2	340 mm

Zoom levels

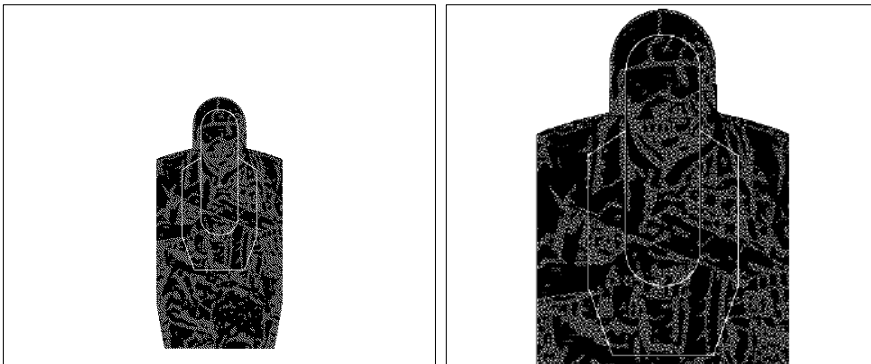

Technical data

Part No	735-0097-97-0404
Size	81 kb
Gauge (default)	7,62 mm
Aiming mark diameter	
Manufacture	
Manufacture Part No	

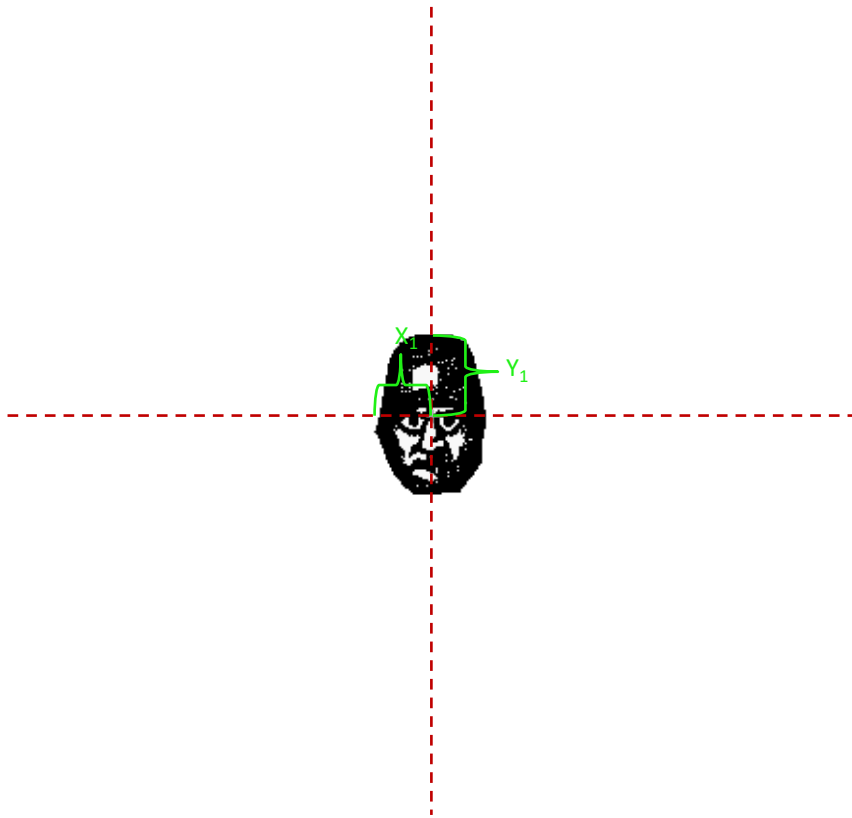

Hit zones (mm)	Value
A	5
B	3

X_1	101 mm
Y_1	145 mm

Zoom levels

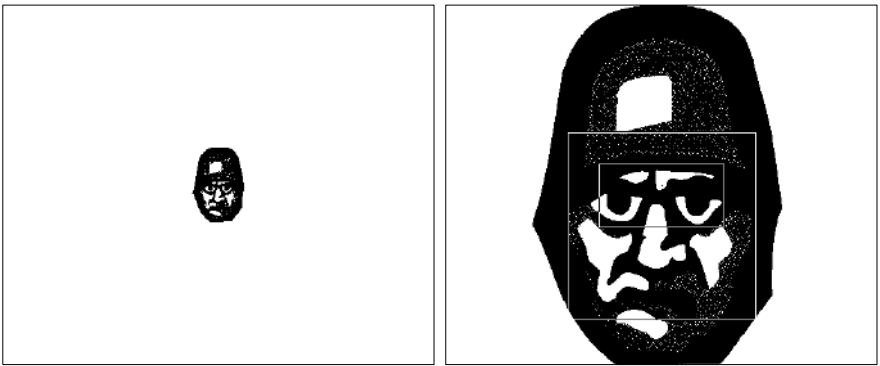

Technical data

Part No	735-0097-97-0408
Size	34,2 kb
Gauge (default)	5,56 mm
Aiming mark diameter	
Manufacture	
Manufacture Part No	

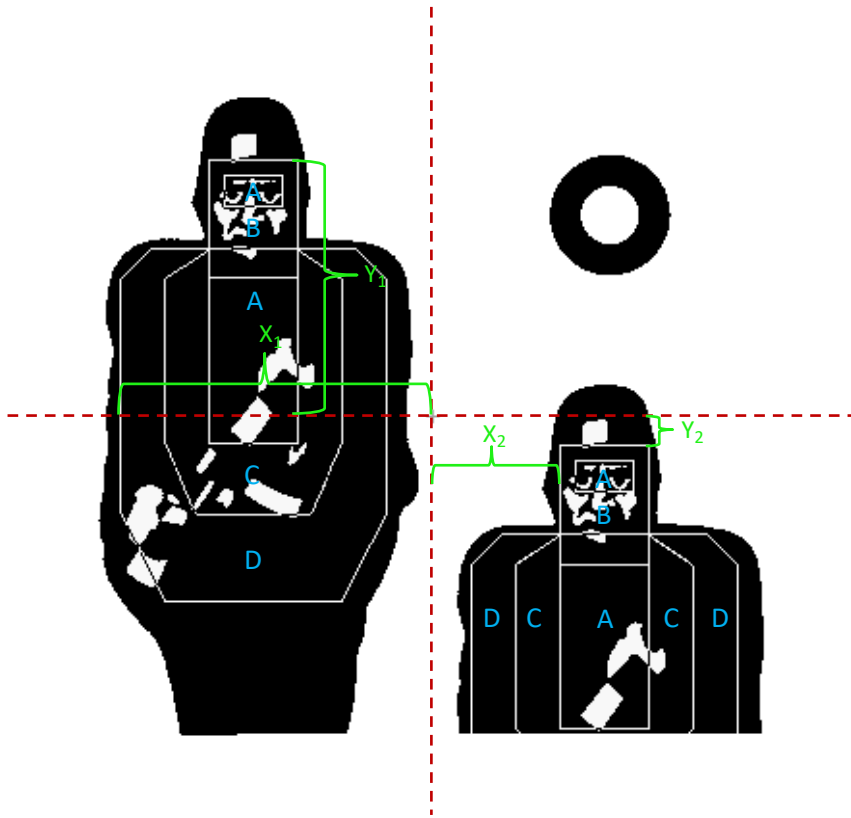

Hit zones (mm)	Value
A	5
B	3
C	3
D	1

X_1	528 mm	X_2	215 mm
Y_1	435 mm	Y_2	50 mm

Zoom levels

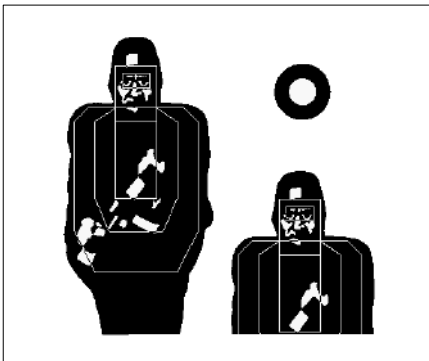

Technical data

Part No	735-0097-97-0410
Size	57,8 kb
Gauge (default)	5,56 mm
Aiming mark diameter	
Manufacture	
Manufacture Part No	

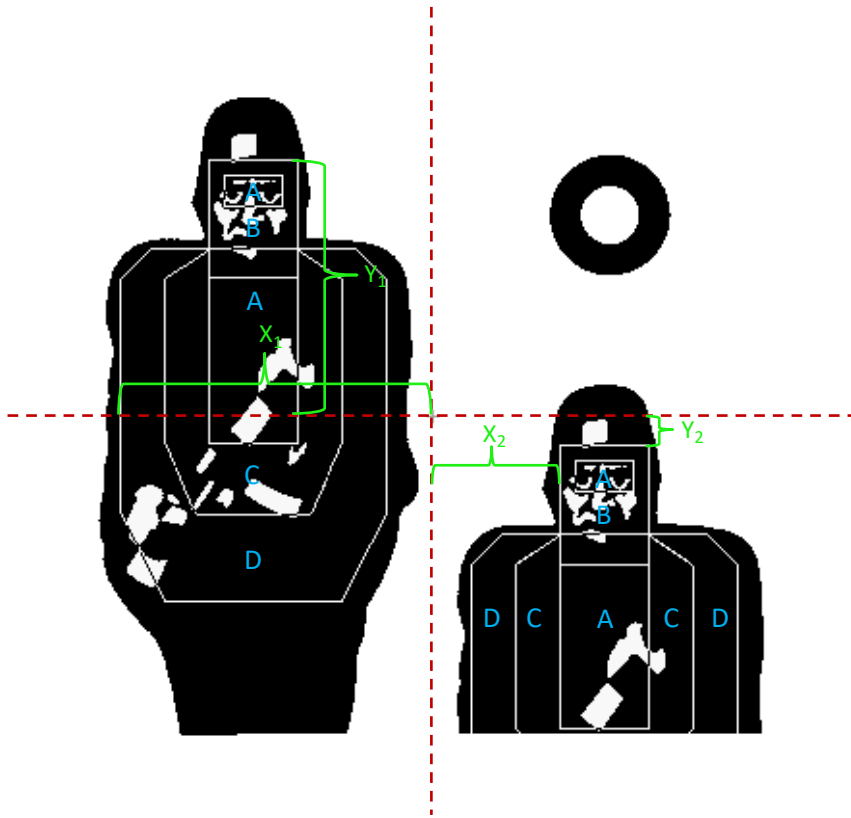

Hit zones (mm)	Value
A	5
B	4
C	4
D	2

X_1	528 mm	X_2	215 mm
Y_1	435 mm	Y_2	50 mm

Zoom levels

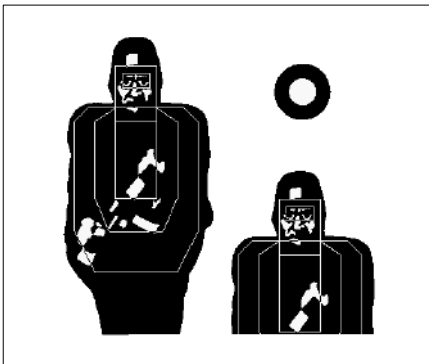

Technical data

Part No	735-0097-97-0411
Size	57,8 kb
Gauge (default)	7,62 mm
Aiming mark diameter	
Manufacture	
Manufacture Part No	

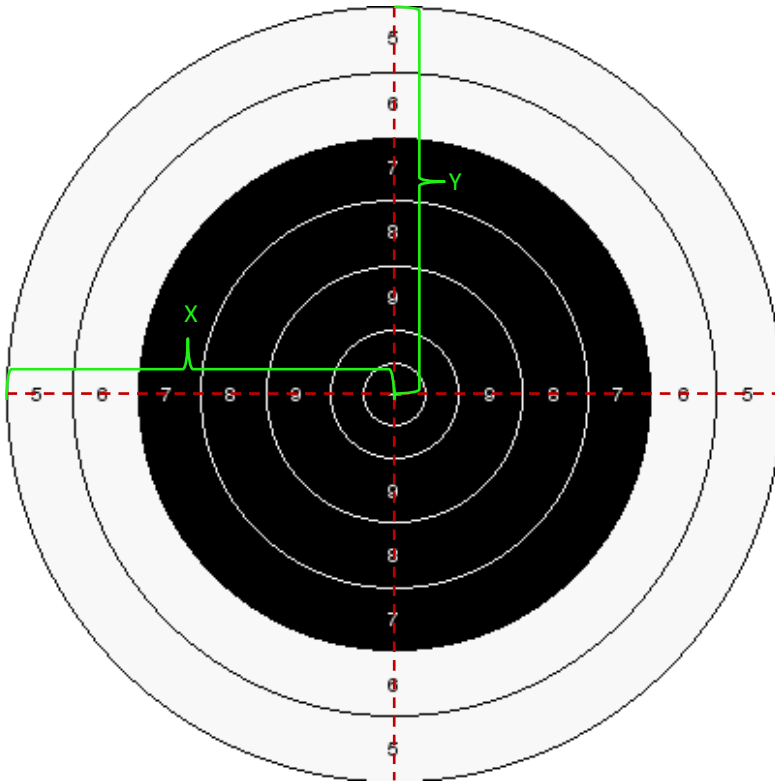

Diameter (mm)	Value
25,4	X
50,8	10
101,6	9
152,4	8
203,2	7
254	6
304,8	5

X	152,4 mm
Y	152,4 mm

Zoom levels

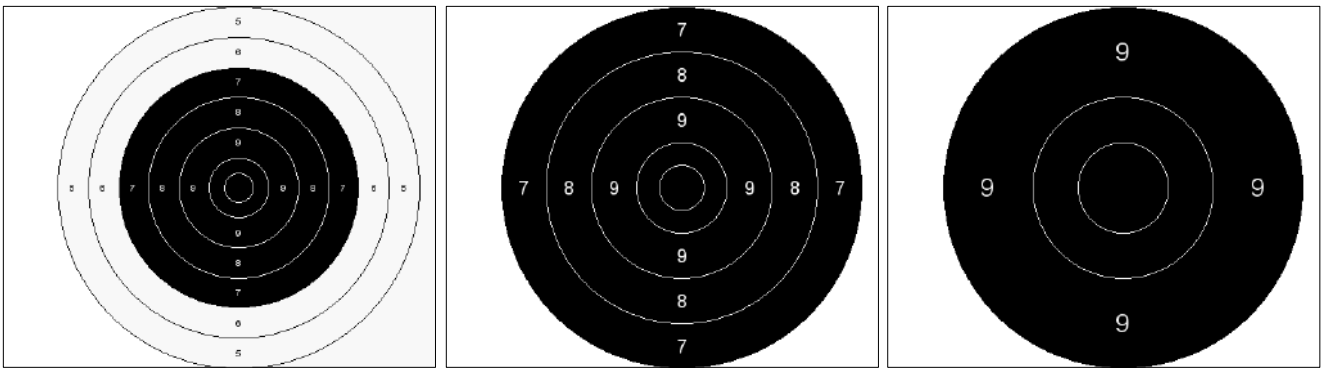

Technical data

Part No	735-0097-97-0413
Size	N/A
Gauge (default)	5,6 mm
Aiming mark diameter	203,2 mm
Manufacture	
Manufacture Part No	

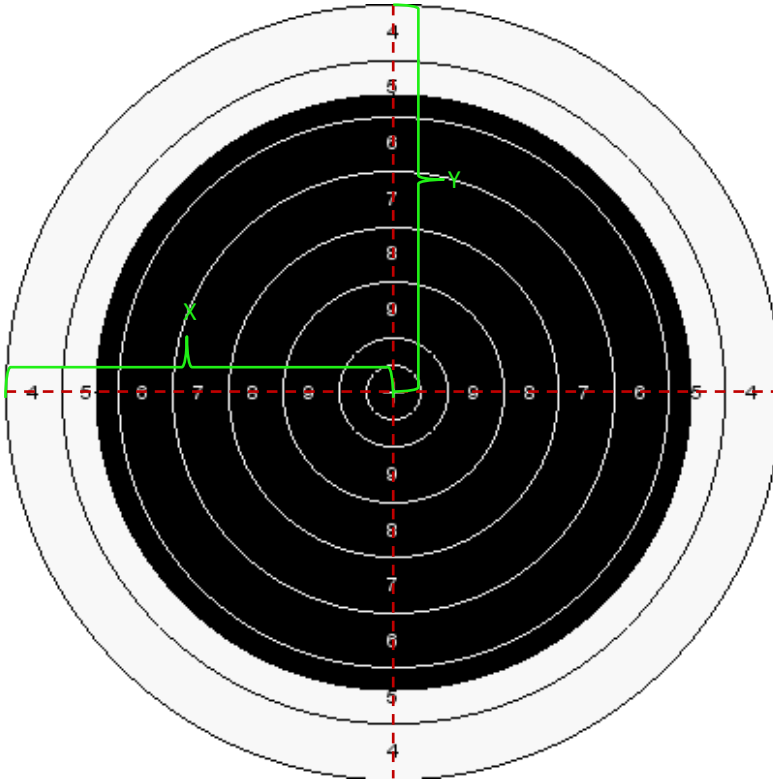

Diameter (mm)	Value
9,9822	X
19,9898	10
39,9796	9
59,9694	8
79,9592	7
99,9744	6
119,9642	5
139,954	4

X	69,977 mm
Y	69,977 mm

Zoom levels

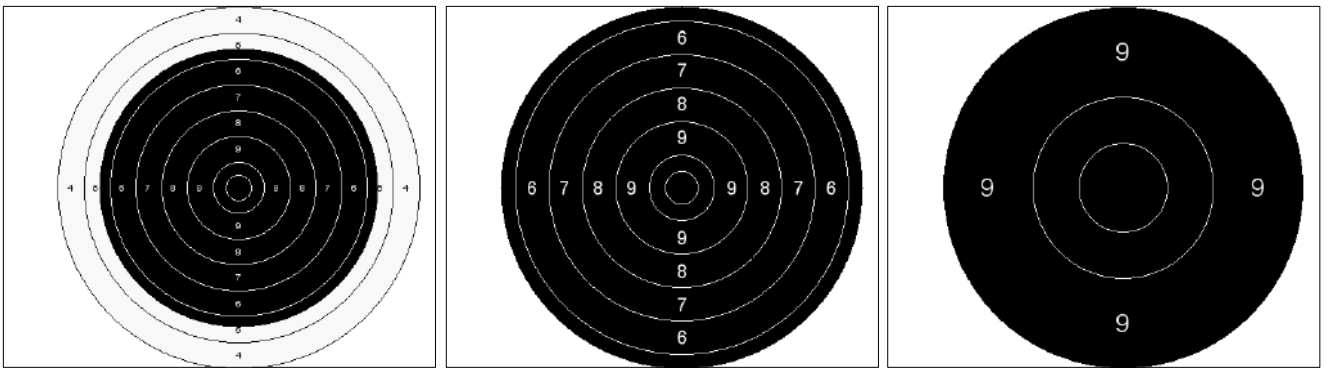

Technical data

Part No	735-0097-97-0414
Size	N/A
Gauge (default)	5,6 mm
Aiming mark diameter	108,458 mm
Manufacture	
Manufacture Part No	

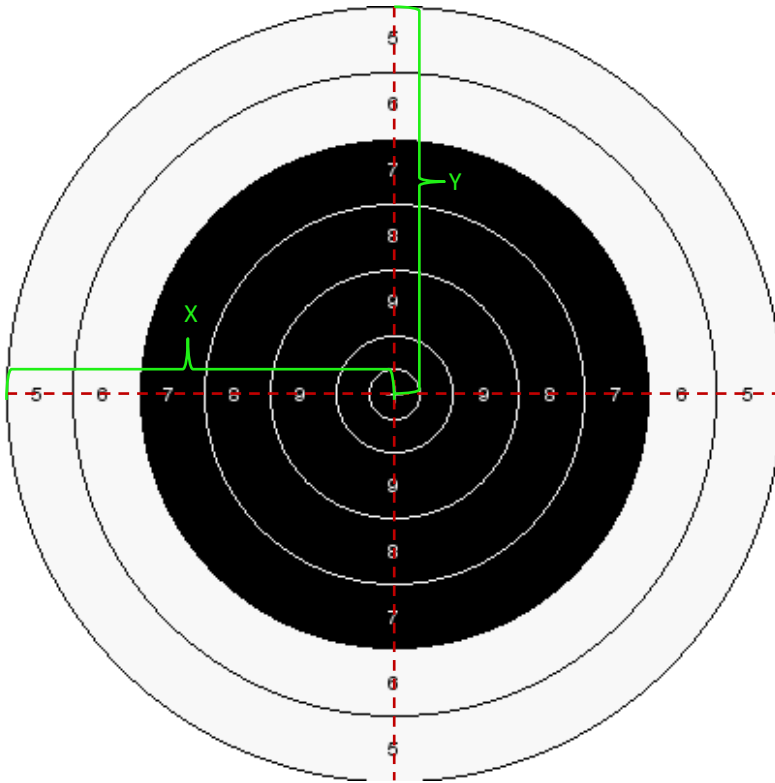

Diameter (mm)	Value
9,906	X
22,606	10
48,006	9
73,406	8
98,806	7
124,206	6
149,606	5

X	74,803 mm
Y	74,803 mm

Zoom levels

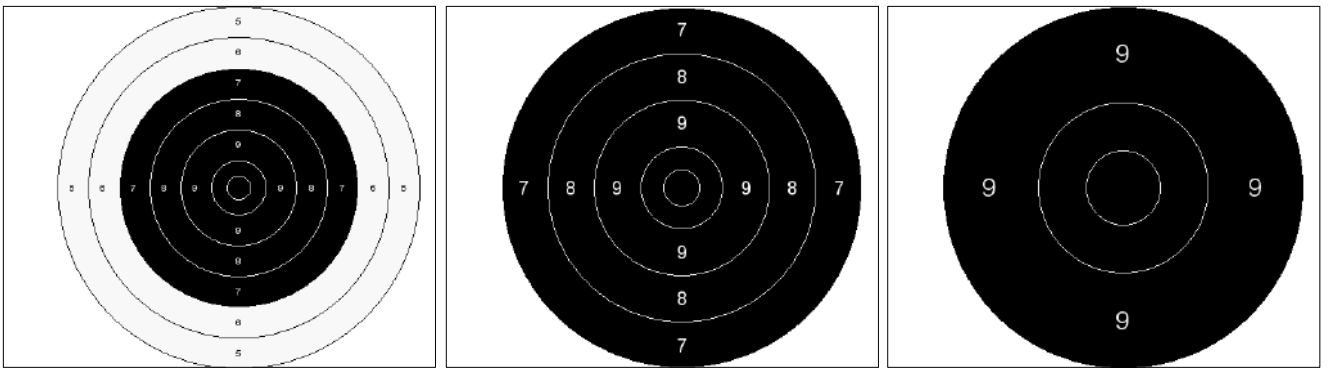

Technical data

Part No	735-0097-97-0415
Size	N/A
Gauge (default)	5,6 mm
Aiming mark diameter	98,806 mm
Manufacture	
Manufacture Part No	

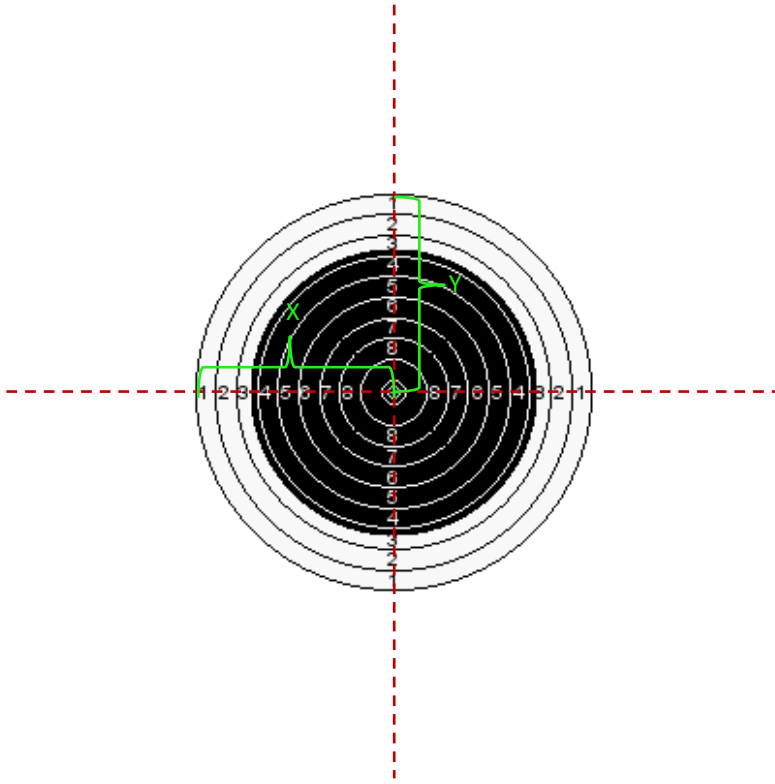

Diameter (mm)	Value
5	*
10,4	X
26,4	9
42,4	8
58,4	7
74,4	6
90,4	5
106,4	4
122,4	3
138,4	2
154,4	1

X	154,4 mm
Y	154,4 mm

Zoom levels

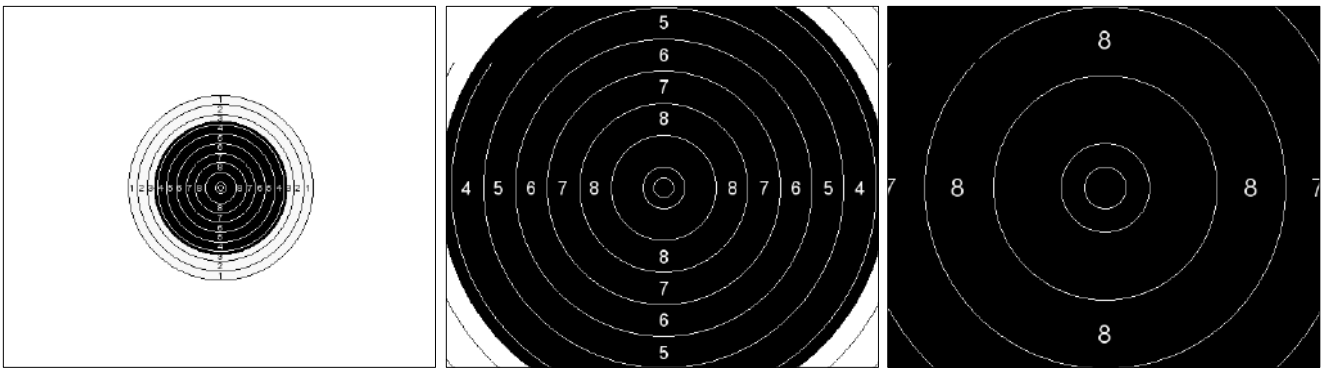

Technical data

Part No	735-0097-97-0418
Size	
Gauge (default)	5,6 mm
Aiming mark diameter	112,4 mm
Manufacture	
Manufacture Part No	

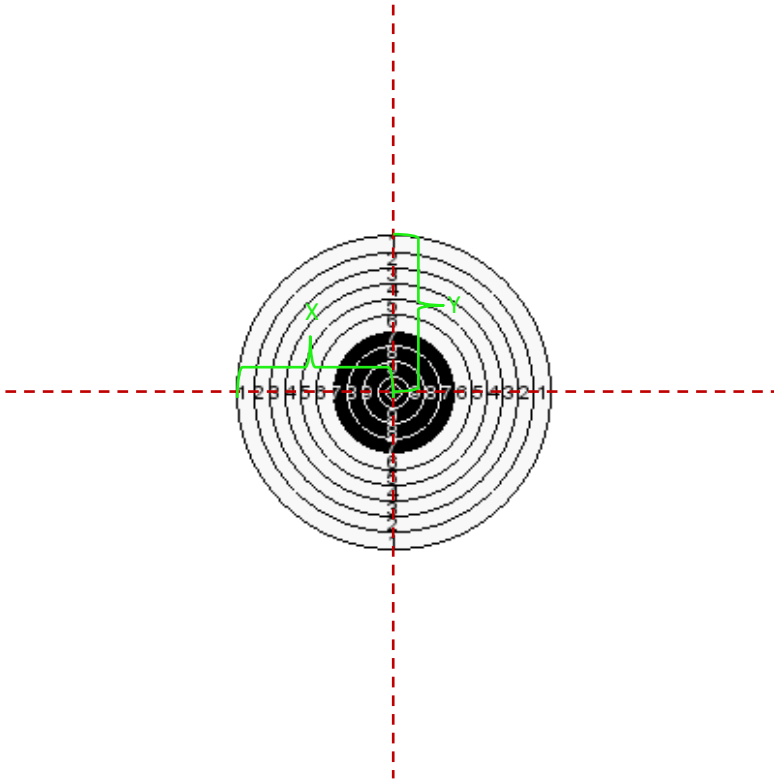

Diameter (mm)	Value
7,5	*
15	X
30	9
45	8
60	7
75	6
90	5
105	4
120	3
135	2
150	1

X	150 mm
Y	150 mm

Zoom levels

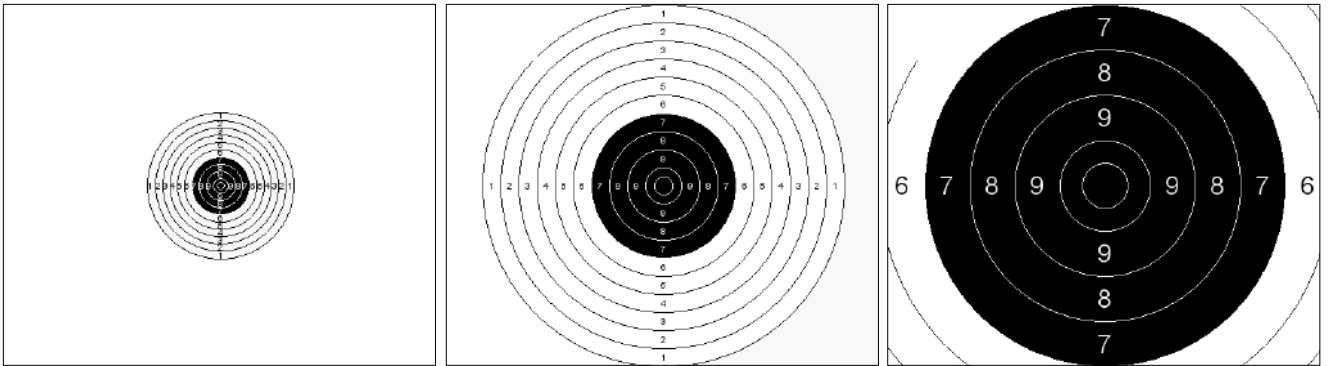

Technical data

Part No	735-0097-97-0419
Size	N/A
Gauge (default)	1,2 mm
Aiming mark diameter	60 mm
Manufacture	
Manufacture Part No	

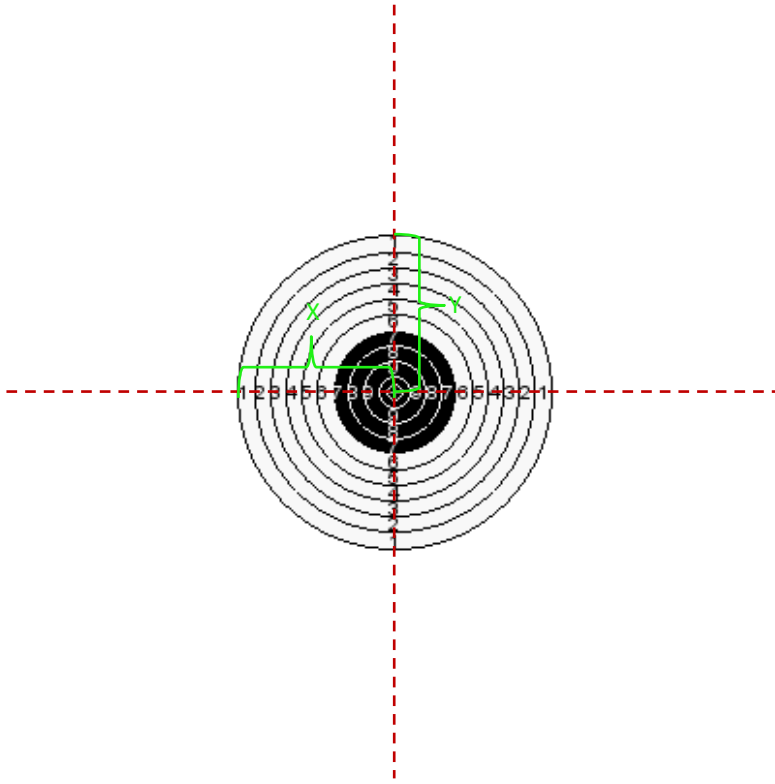

Diameter (mm)	Value
7,5	*
15	X
30	9
45	8
60	7
75	6
90	5
105	4
120	3
135	2
150	1

X	150 mm
Y	150 mm

Zoom levels

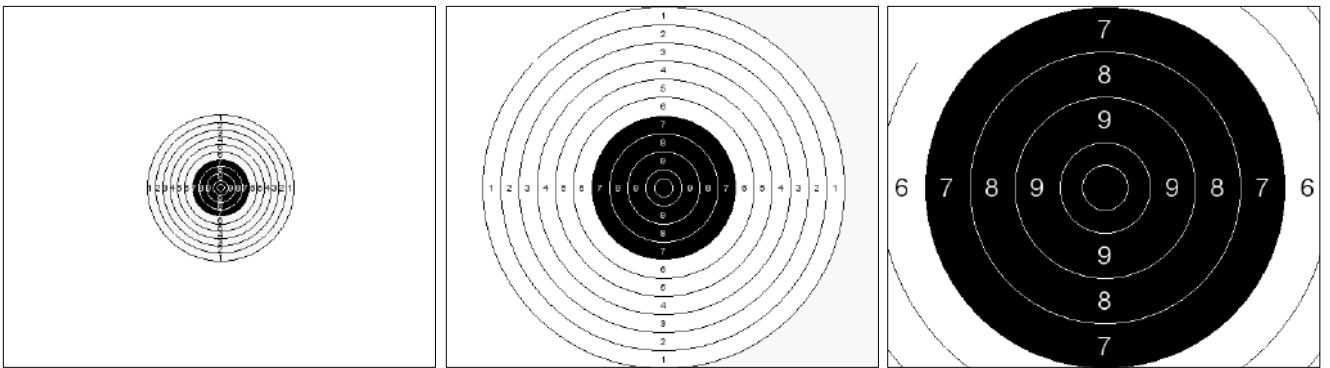

Technical data

Part No	735-0097-97-0420
Size	N/A
Gauge (default)	1,2 mm
Aiming mark diameter	60 mm
Manufacture	
Manufacture Part No	

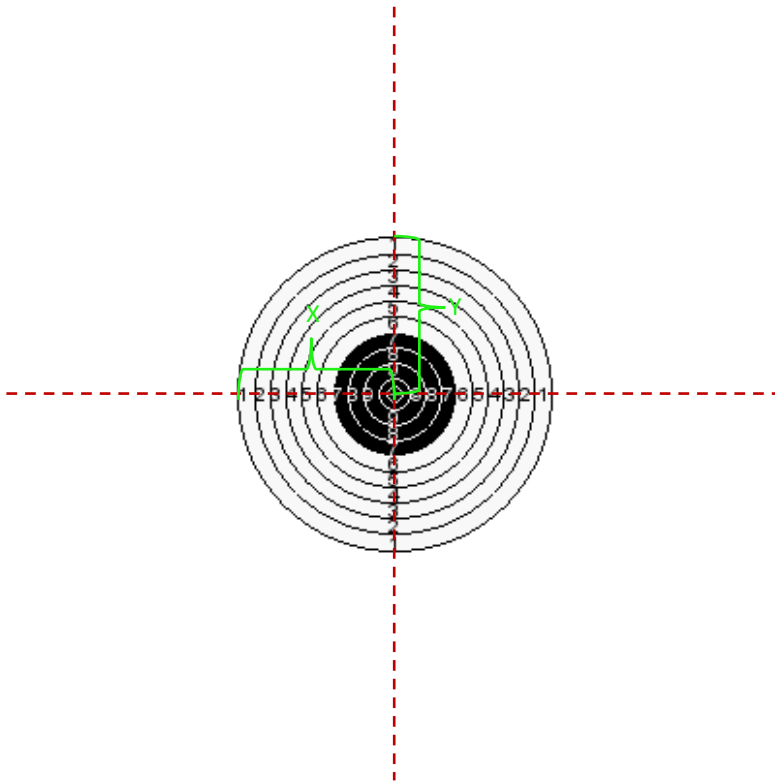

Diameter (mm)	Value
7,5	*
15	X
30	9
45	8
60	7
75	6
90	5
105	4
120	3
135	2
150	1

X	150 mm
Y	150 mm

Zoom levels

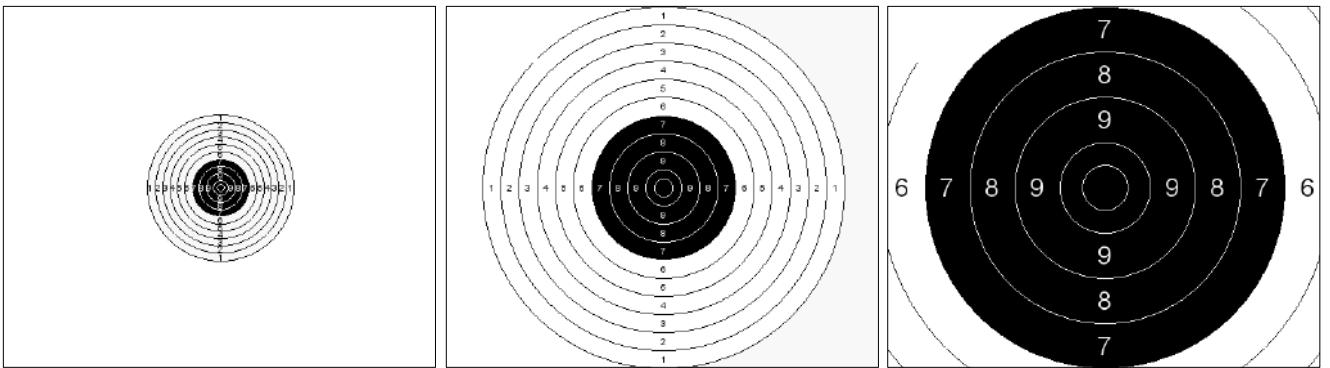

Technical data

Part No	735-0097-97-0422
Size	N/A
Gauge (default)	1,2 mm
Aiming mark diameter	60 mm
Manufacture	
Manufacture Part No	

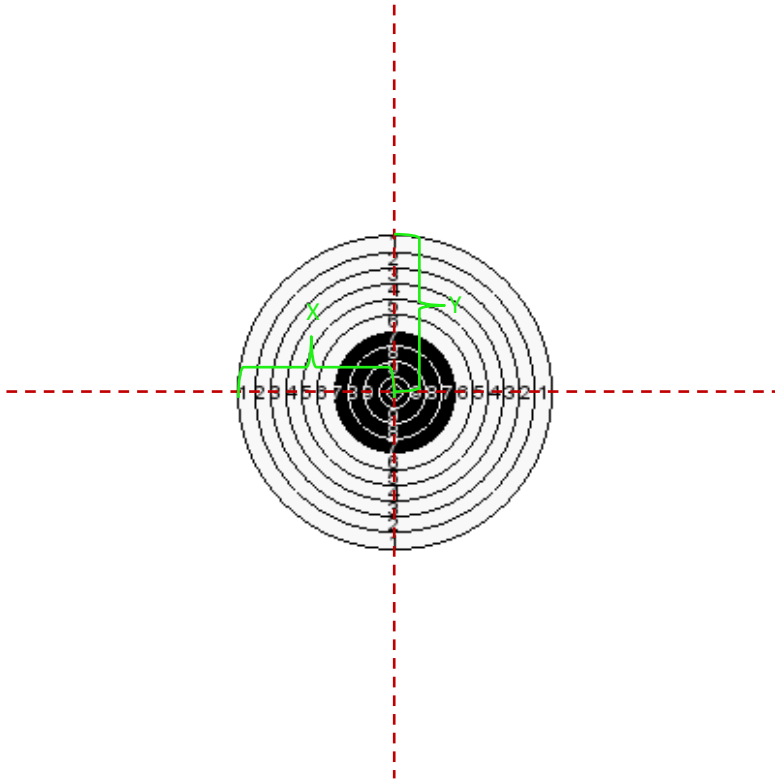

Diameter (mm)	Value
7,5	*
15	X
30	9
45	8
60	7
75	6
90	5
105	4
120	3
135	2
150	1

X	150 mm
Y	150 mm

Zoom levels

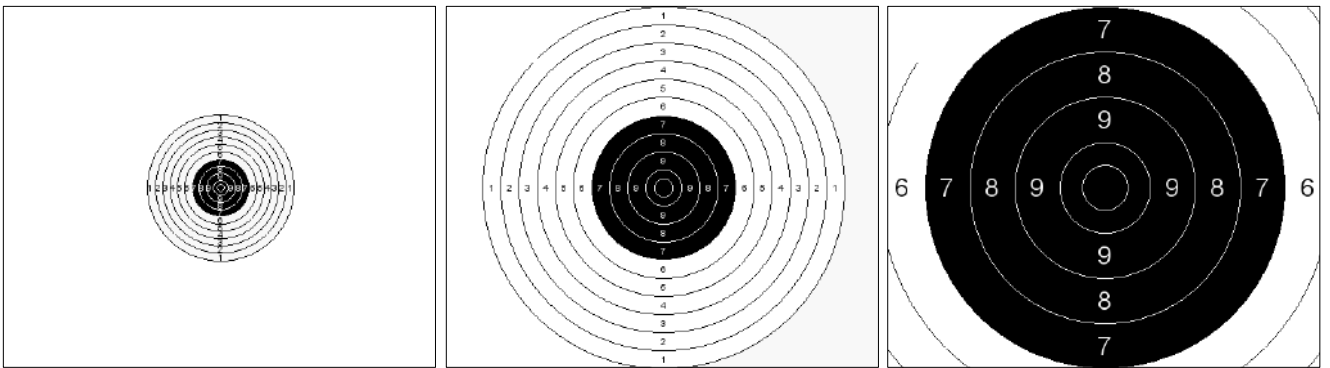

Technical data

Part No	735-0097-97-0423
Size	N/A
Gauge (default)	1,2 mm
Aiming mark diameter	60 mm
Manufacture	
Manufacture Part No	

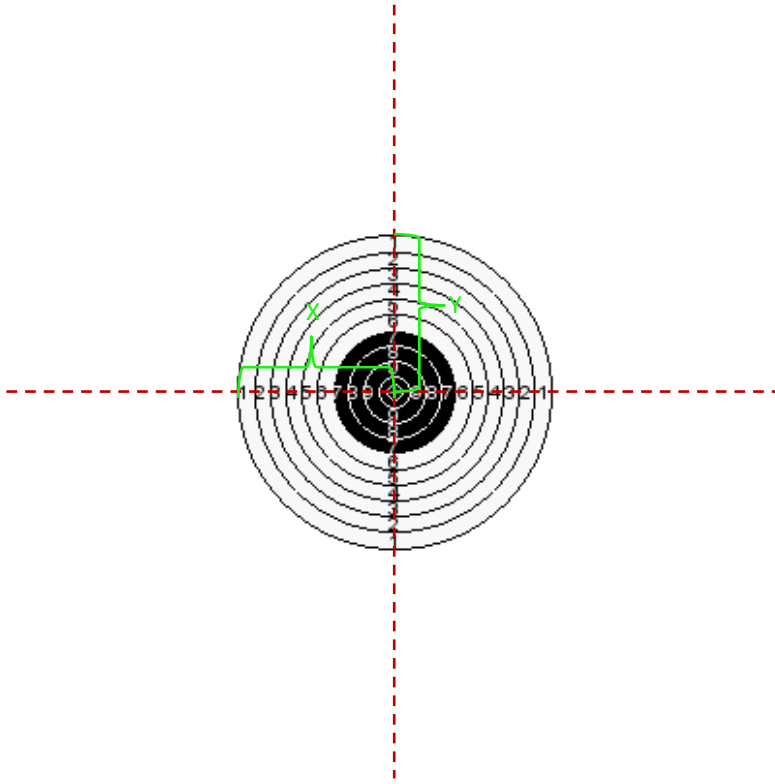

Diameter (mm)	Value
7,5	*
15	X
30	9
45	8
60	7
75	6
90	5
105	4
120	3
135	2
150	1

X	150 mm
Y	150 mm

Zoom levels

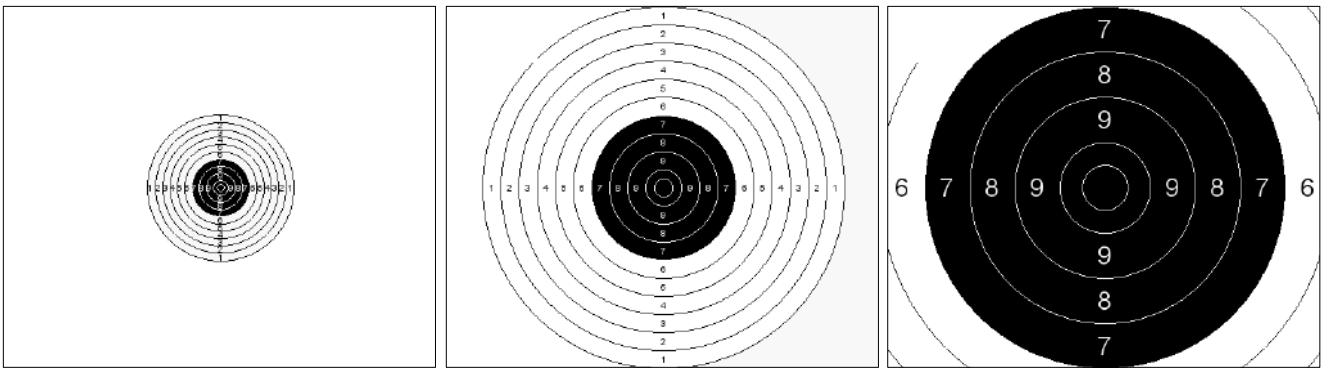

Technical data

Part No	735-0097-97-0424
Size	N/A
Gauge (default)	1,2 mm
Aiming mark diameter	60 mm
Manufacture	
Manufacture Part No	

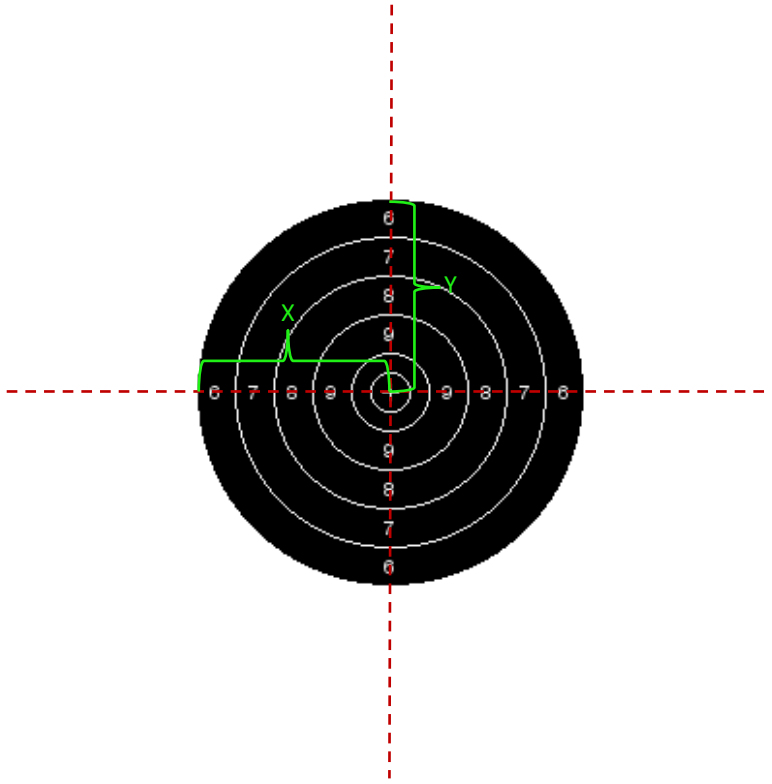

Diameter (mm)	Value
17	*
34	X
68	9
102	8
136	7
170	6

X	85 mm
Y	85 mm

Zoom levels

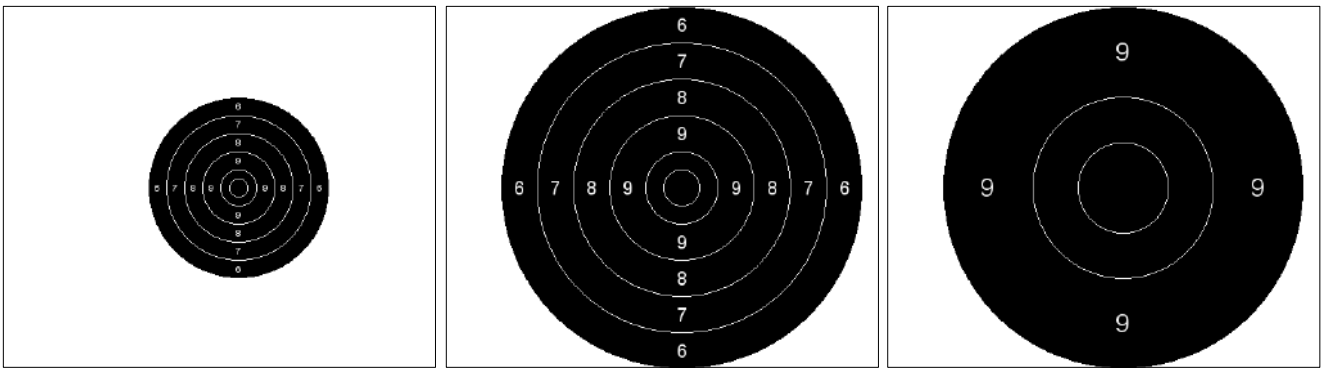

Technical data

Part No	735-0097-97-0425
Size	N/A
Gauge (default)	8 mm
Aiming mark diameter	170 mm
Manufacture	
Manufacture Part No	

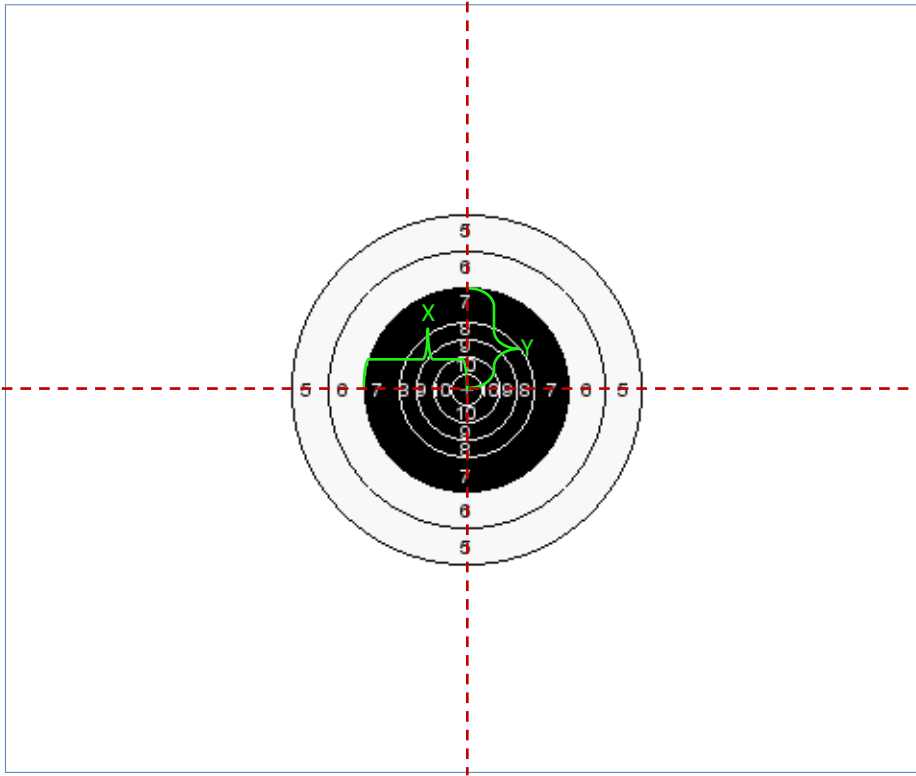

Diameter (mm)	Value
45,466	X
96,266	10
147,066	9
197,866	8
299,466	7
401,066	6
502,666	5

X	149,733 mm
Y	149,733 mm

Zoom levels

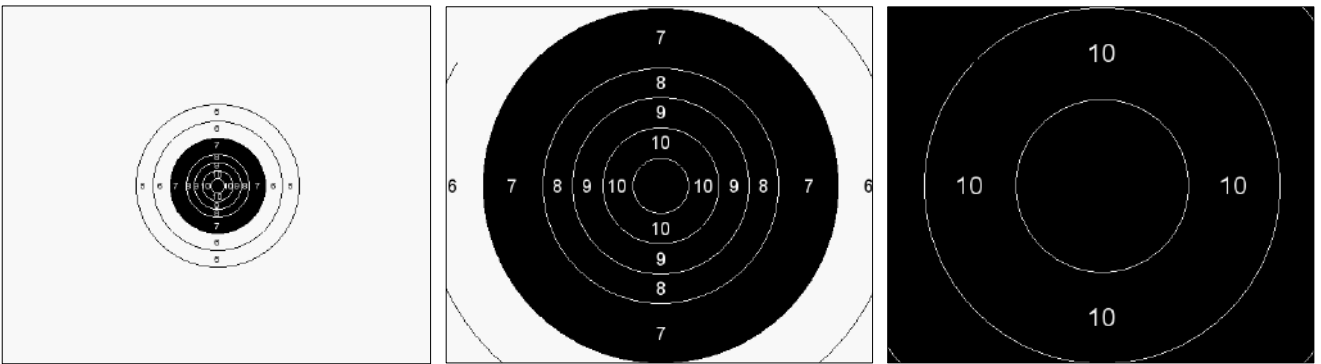

Technical data

Part No	735-0097-97-0426
Size	N/A
Gauge (default)	7,62 mm
Aiming mark diameter	299,466 mm
Manufacture	
Manufacture Part No	

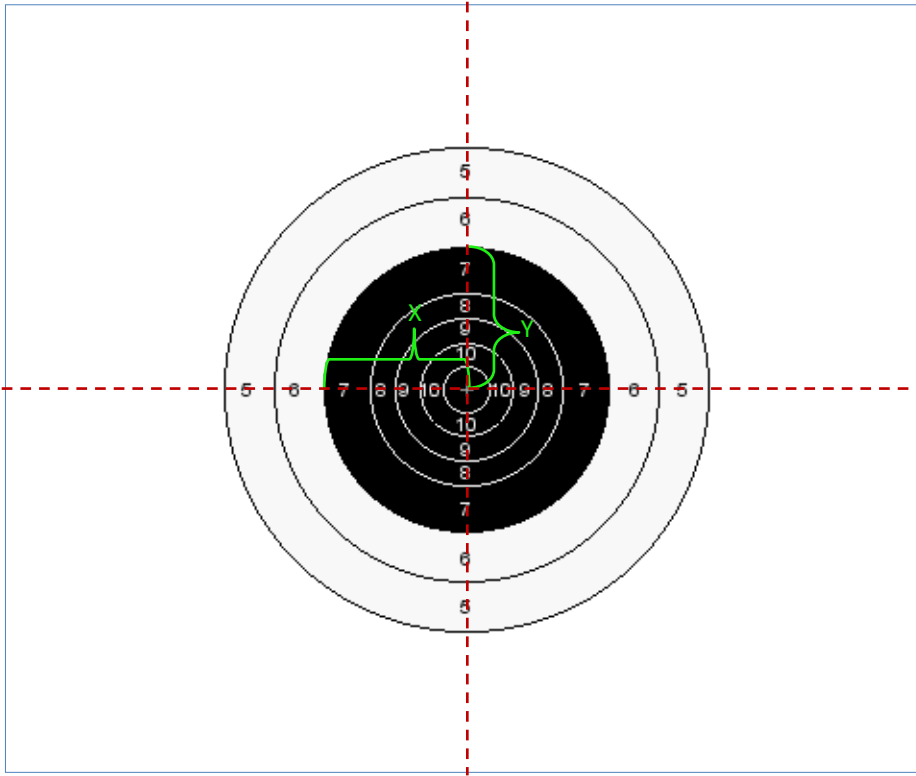

Diameter (mm)	Value
72,390	X
148,590	10
224,790	9
300,990	8
453,390	7
605,790	6
758,190	5

X	226,695 mm
Y	226,695 mm

Zoom levels

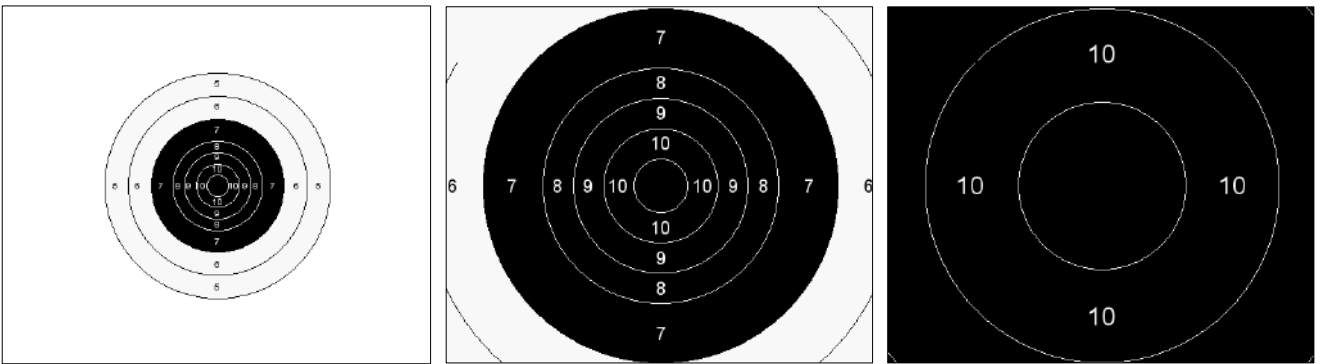

Technical data

Part No	735-0097-97-0427
Size	N/A
Gauge (default)	7,62 mm
Aiming mark diameter	453,390 mm
Manufacture	
Manufacture Part No	

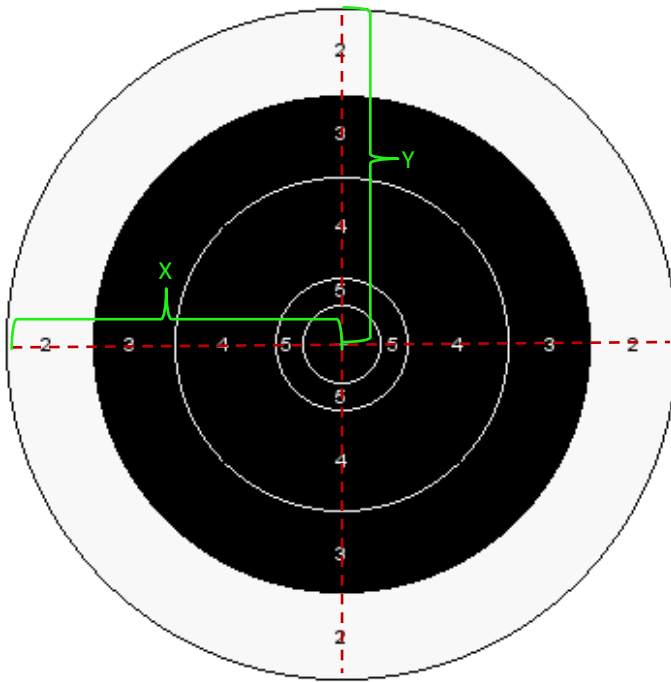

Diameter (mm)	Value
156	V
260	5
660	4
990	3
1320	2

X	660 mm
Y	660 mm

Zoom levels

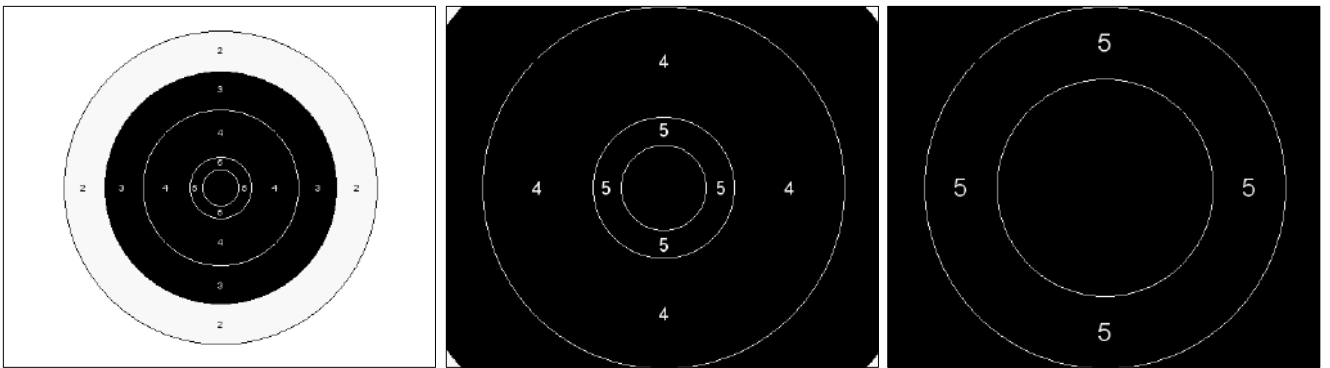

Technical data

Part No	735-0097-97-0431
Size	
Gauge (default)	8 mm
Aiming mark diameter	495 mm
Manufacture	
Manufacture Part No	

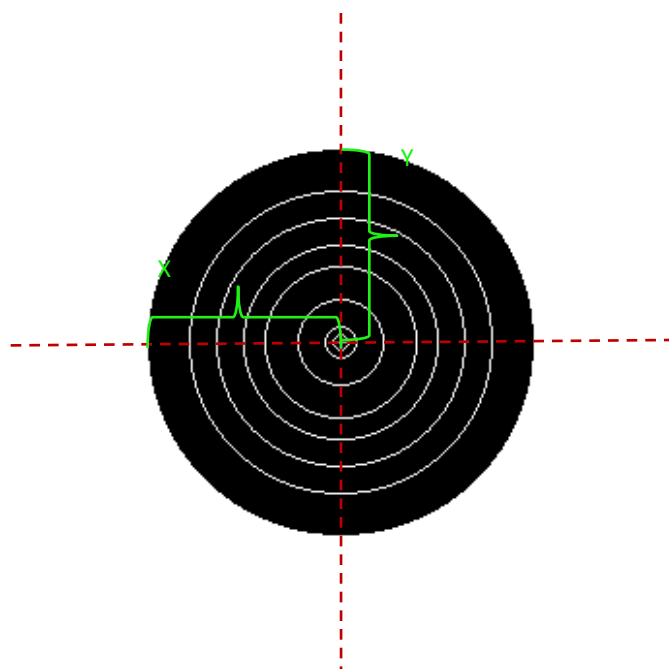

Diameter (mm)	Value
5	*
10	X
26	9
45	8
58	7
74	6
90	5
115	4

X	57,6 mm
Y	57,6 mm

Zoom levels

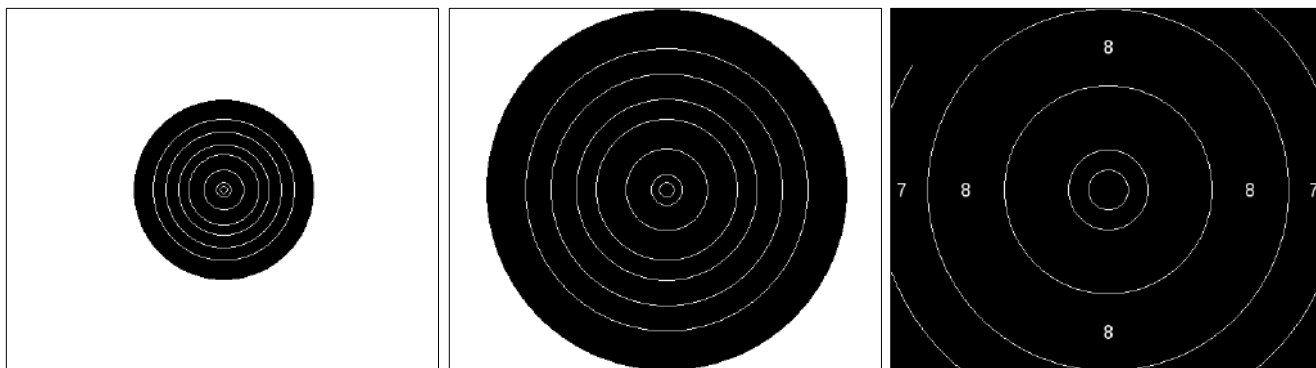

Technical data

Part No	735-0097-97-0432
Size	
Gauge (default)	5,6 mm
Aiming mark diameter	115 mm
Manufacture	
Manufacture Part No	

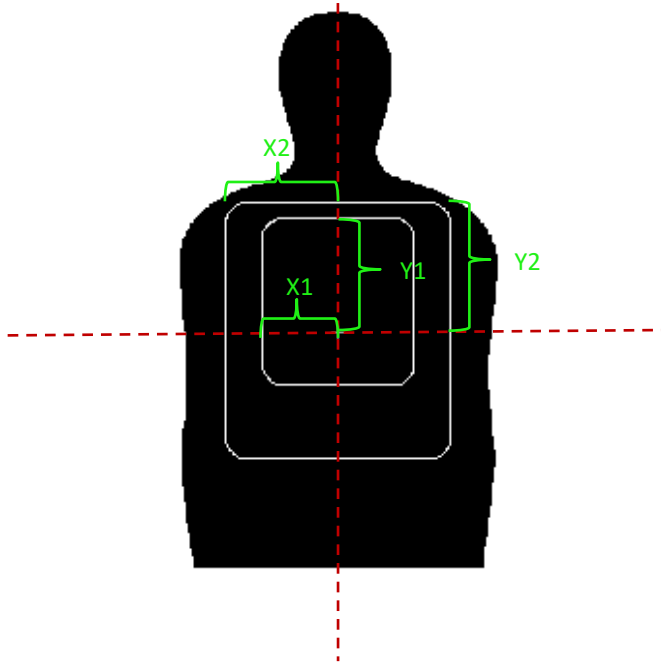

Diameter (mm)	Value
	5
	4
	1

X_1	123 mm	X_2	180 mm
Y_1	180 mm	Y_2	205 mm

Zoom levels

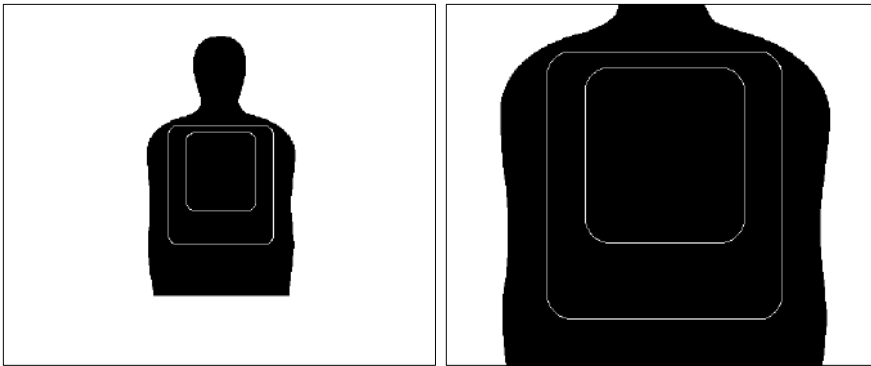

Technical data

Part No	735-0097-97-0433
Size	
Gauge (default)	5,56 mm
Aiming mark diameter	
Manufacture	
Manufacture Part No	

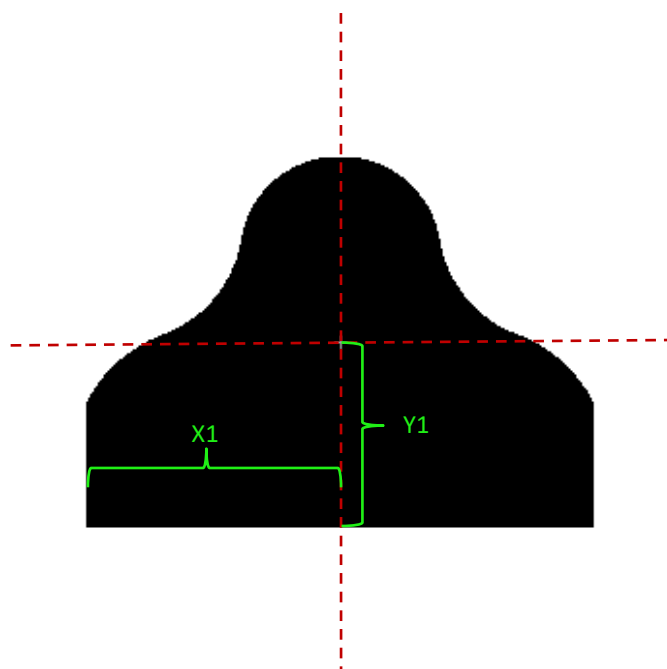

Diameter (mm)	Value
	5

X ₁	330 mm
Y ₁	241 mm

Zoom levels

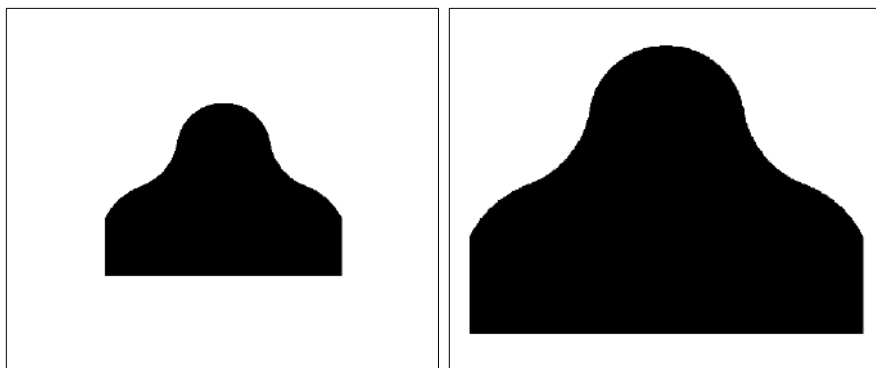

Technical data

Part No	735-0097-97-0434
Size	
Gauge (default)	5,56 mm
Aiming mark diameter	
Manufacture	
Manufacture Part No	

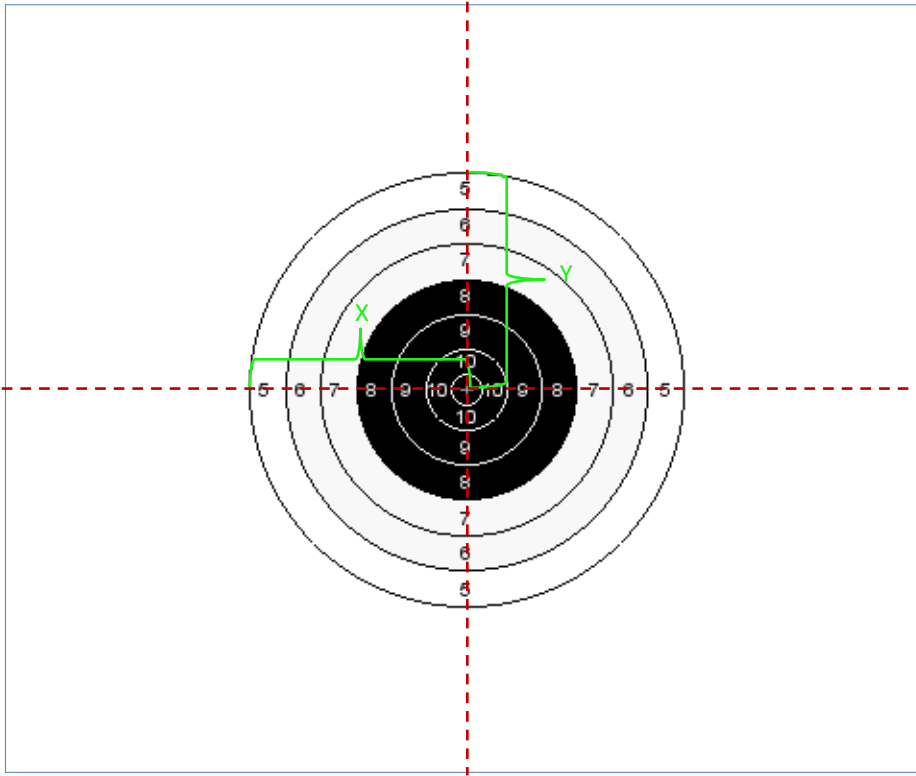

Diameter (mm)	Value
48,26	X
115,83	10
217,42	9
319,02	8
420,62	7
522,22	6
623,82	5

X	311,91 mm
Y	311,91 mm

Zoom levels

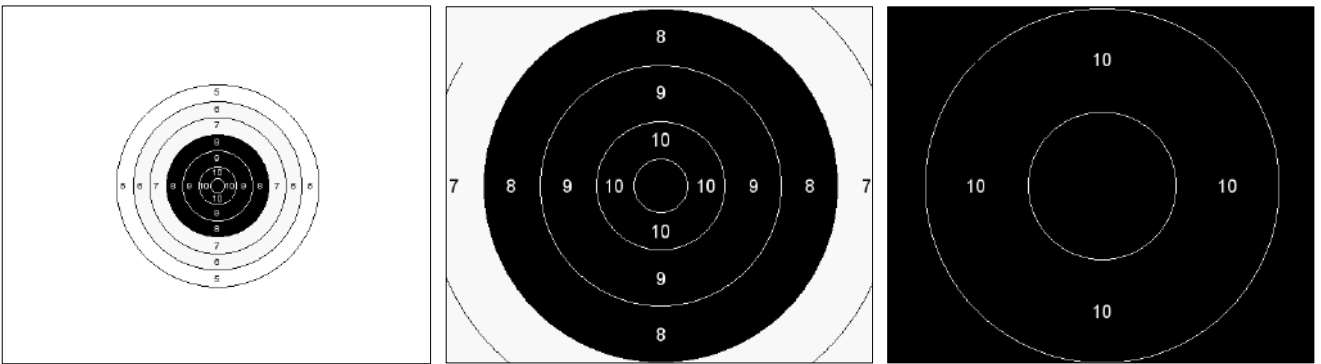

Technical data

Part No	735-0097-97-0436
Size	N/A
Gauge (default)	7,62 mm
Aiming mark diameter	319,02 mm
Manufacture	
Manufacture Part No	

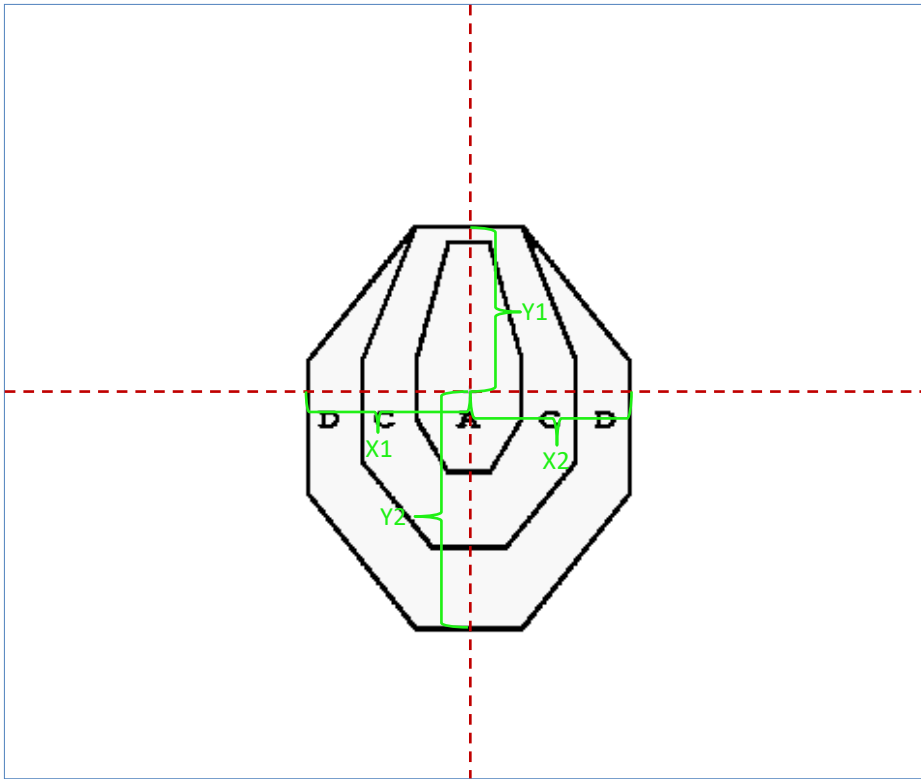

Diameter (mm)	Value
A	1
C	1
D	1
ROT	0

X1	150 mm	X2	150 mm
Y1	155 mm	Y2	220 mm

Zoom levels

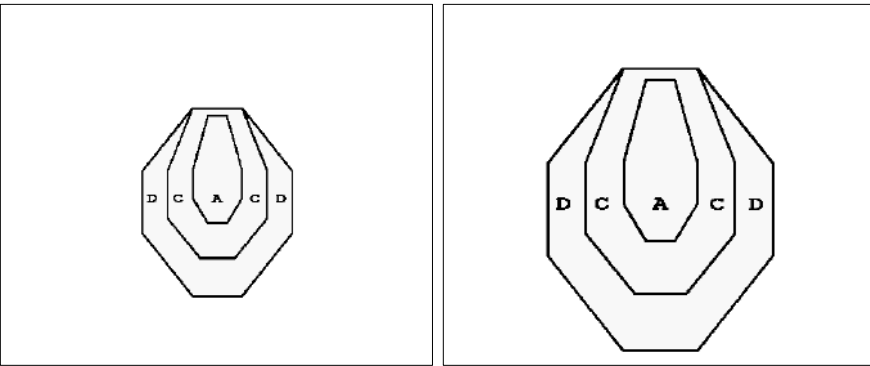

Technical data

Part No	735-0097-97-0439
Size	81 kB
Gauge (default)	8 mm
Aiming mark diameter	
Manufacture	
Manufacture Part No	

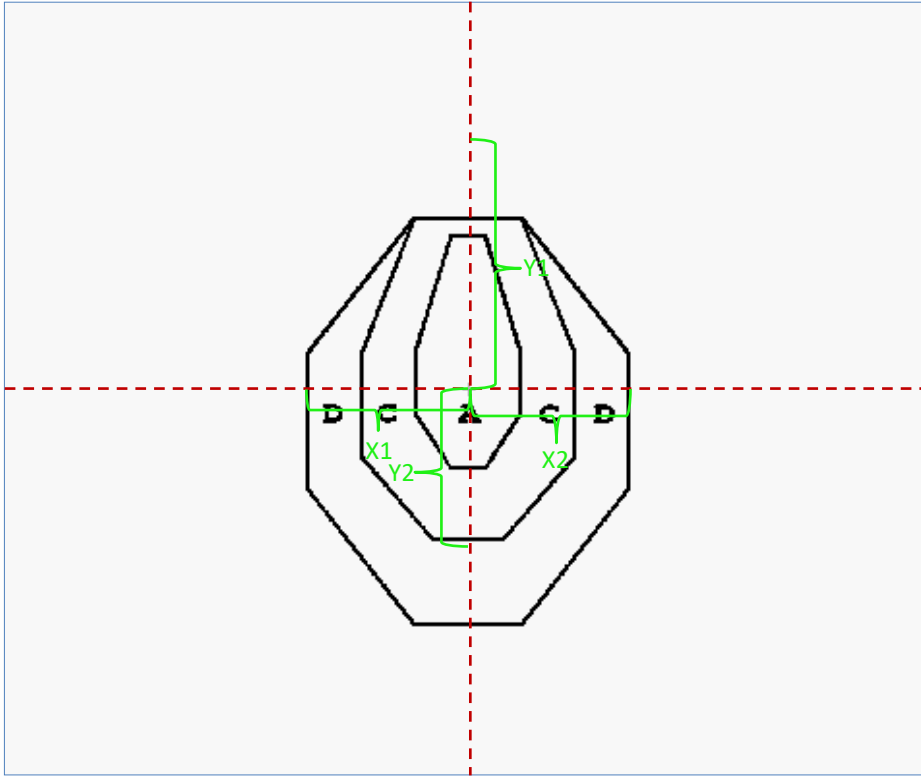

Diameter (mm)	Value
A	1
C	1
D	1
ROT	0

X1	225 mm	X2	225 mm
Y1	240 mm	Y2	330 mm

Zoom levels

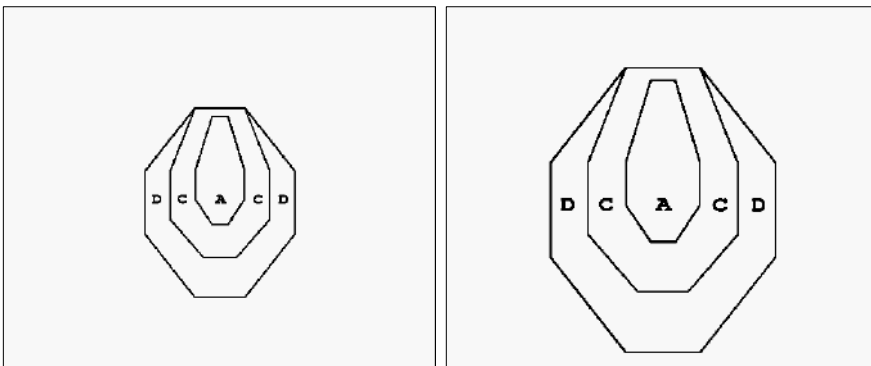

Technical data

Part No	735-0097-97-0440
Size	93 kB
Gauge (default)	8 mm
Aiming mark diameter	
Manufacture	
Manufacture Part No	

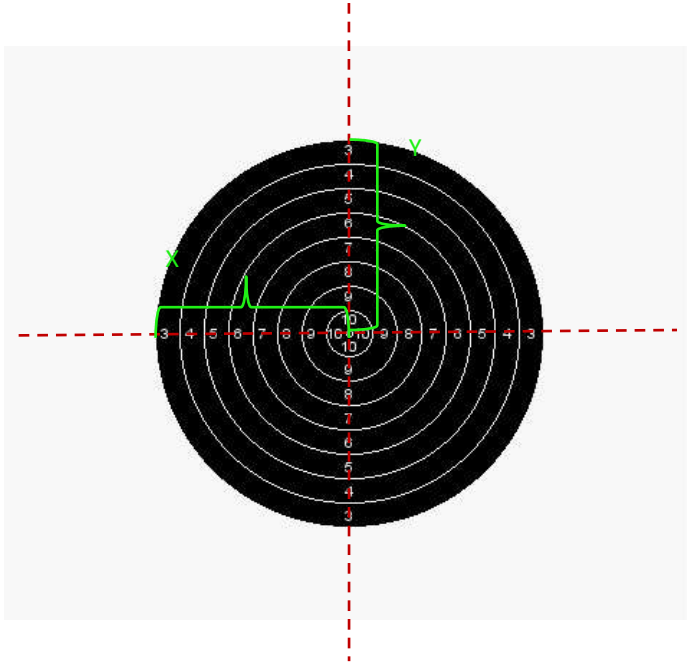

Diameter (mm)	Value
1,9	*
12,7	X
25,4	9
38,1	8
50,8	7
63,5	6
76,2	5
88,9	4
101,6	3

X	50,8 mm
Y	50,8 mm

Zoom levels

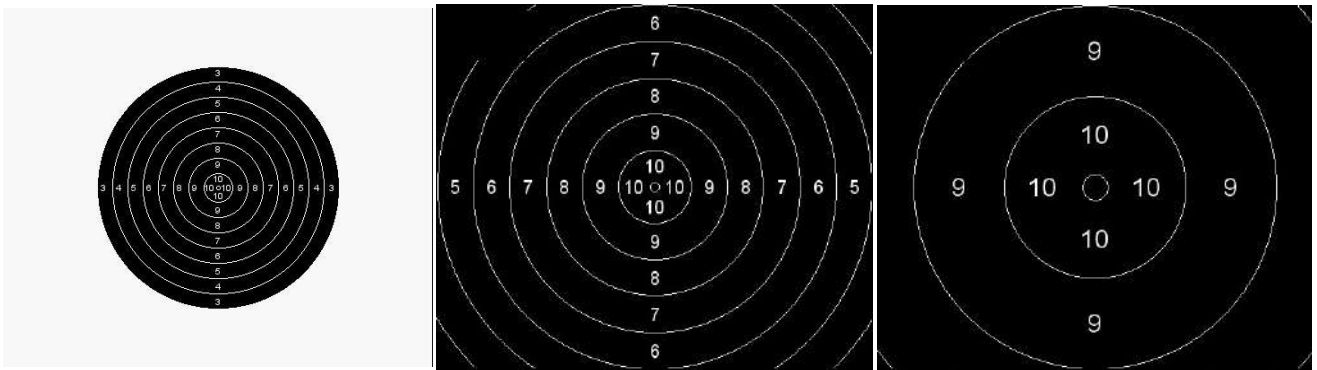

Technical data

Part No	735-0097-97-0441
Size	
Gauge (default)	8,0 mm
Aiming mark diameter	101,6 mm
Manufacture	
Manufacture Part No	

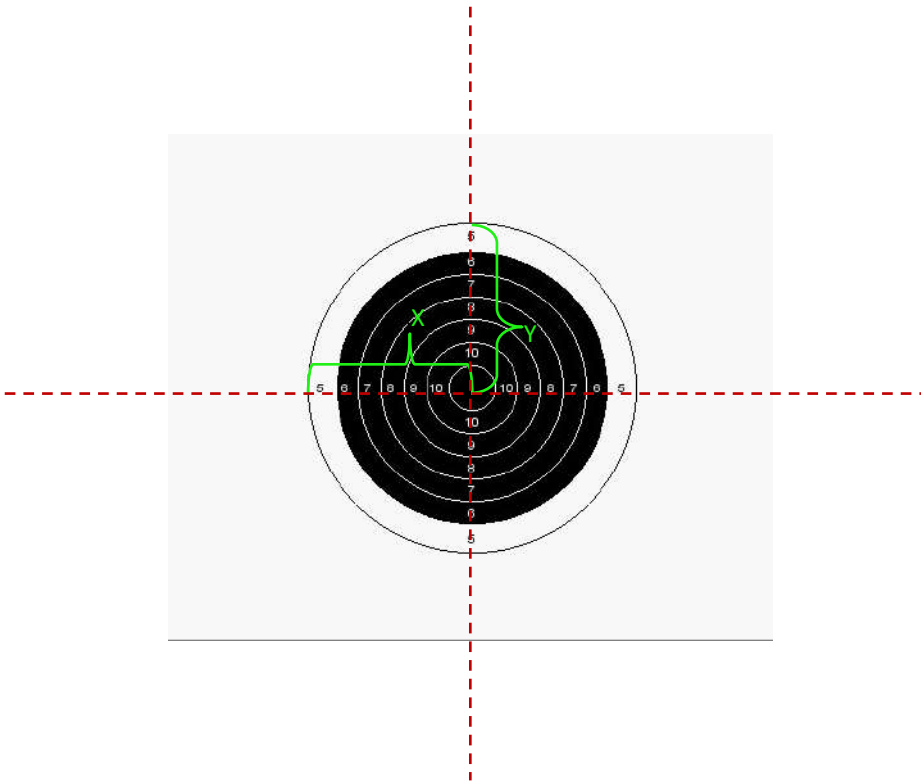

Diameter (mm)	Value
63,5	X
127,0	10
190,5	9
254,0	8
317,5	7
381,0	6
457,2	5

X	228,6 mm
Y	228,6 mm

Zoom levels

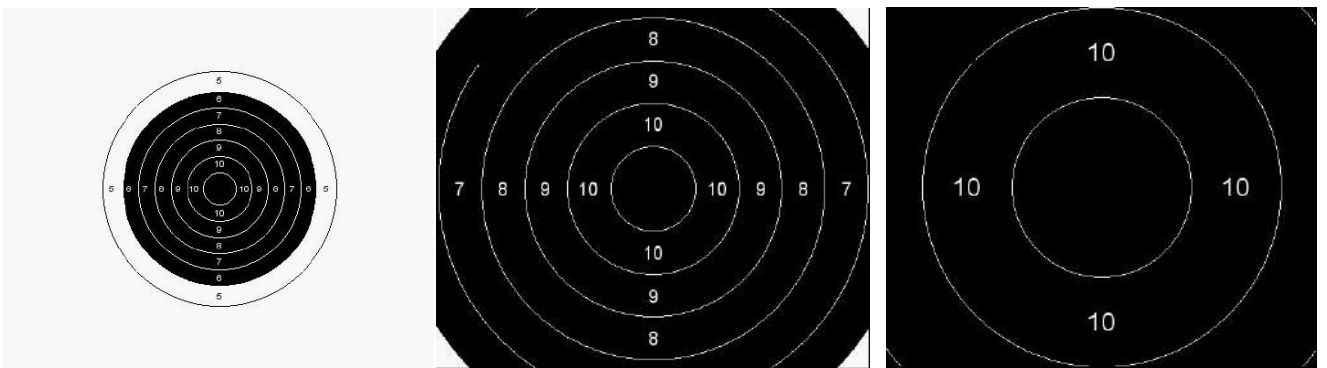

Technical data

Part No	735-0097-97-0442
Size	N/A
Gauge (default)	7,62 mm
Aiming mark diameter	381 mm
Manufacture	
Manufacture Part No	

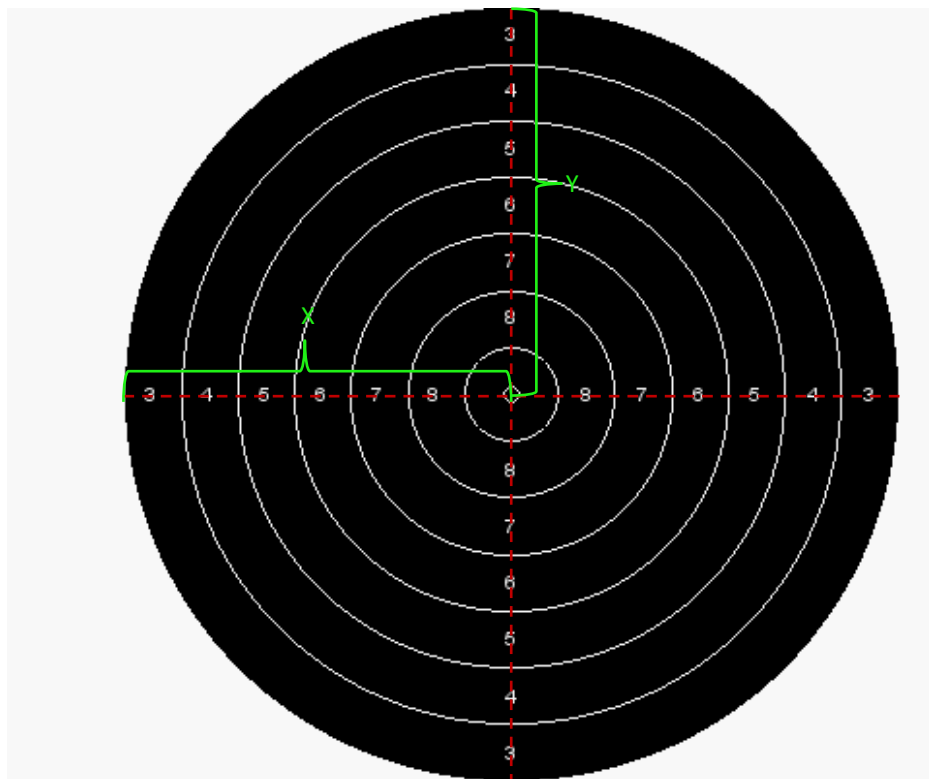

Diameter (mm)	Value
	10x
0,76	10
4,12	9
9,00	8
13,87	7
18,75	6
23,63	5
28,50	4
33,38	3

X	16,69 mm
Y	16,69 mm

Zoom levels

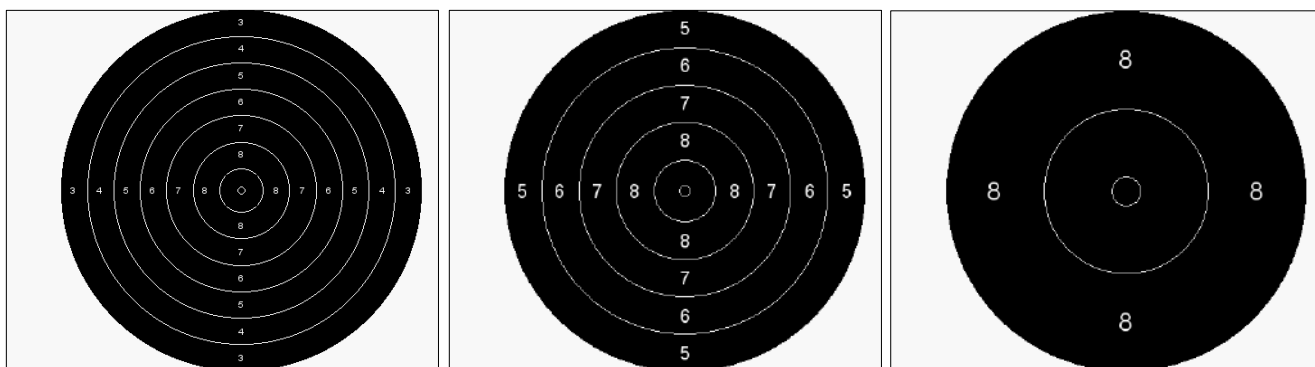

Technical data

Part No	735-0097-97-0443
Size	N/A
Gauge (default)	5,6 mm
Aiming mark diameter	33,38 mm
Manufacture	
Manufacture Part No	

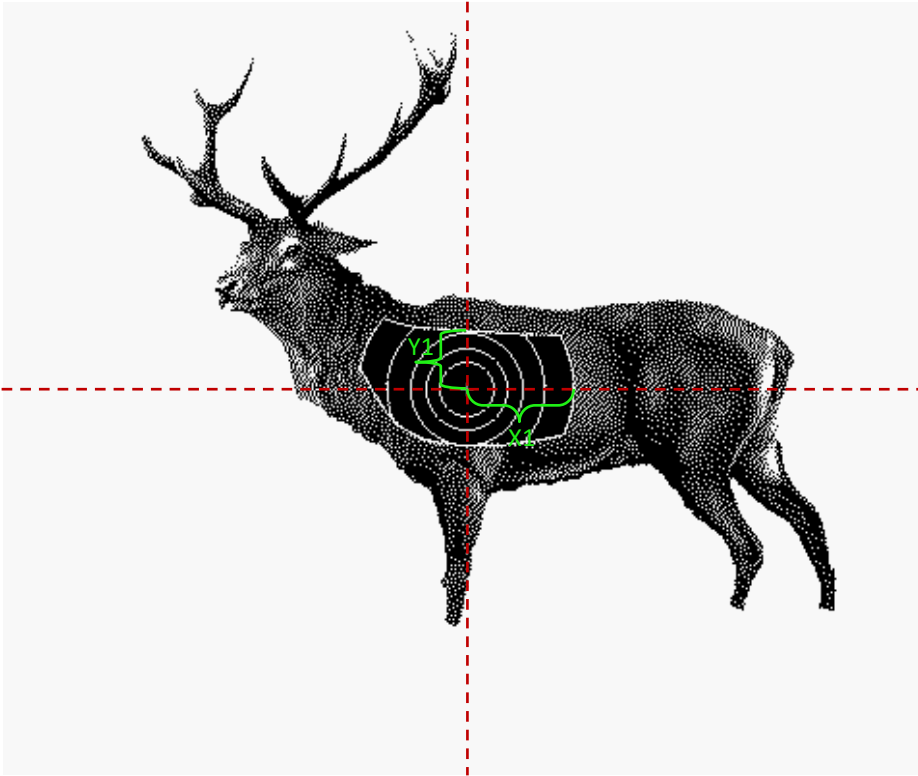

Diameter (mm)	Value
95	10
145	9
195	8
270*	3
370*	1
*	Hitzone

X1	185		
Y1	97,5		

Zoom levels

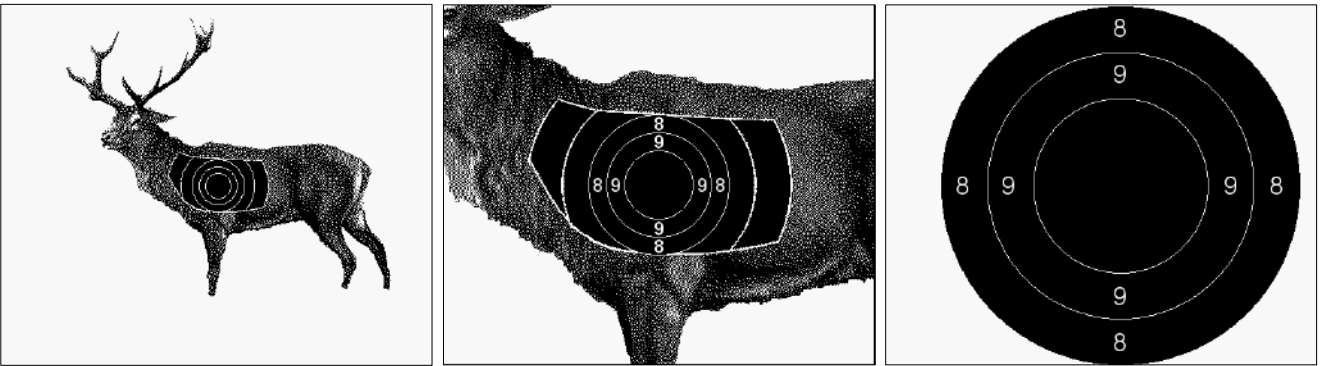

Technical data

Part No	735-0097-97-0446
Size	95 kb
Gauge (default)	8 mm
Aiming mark diameter	N/A
Manufacture	
Manufacture Part No	

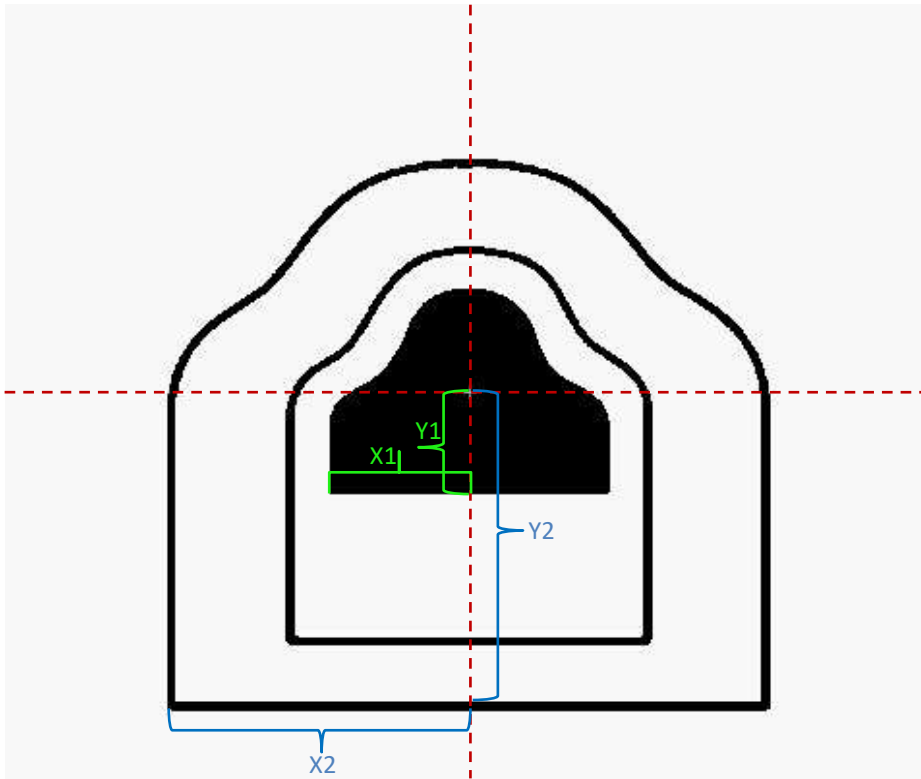

Diameter (mm)	Value
Inner	5
Mid	4
Outer	3
6x6 feet square	2
Rest	0

X1	13 inches / 330.2 mm	X2	28 inches / 711.2 mm
Y1	9 ½ inches / 241.3 mm	Y2	29 ½ inches / 749.3 mm



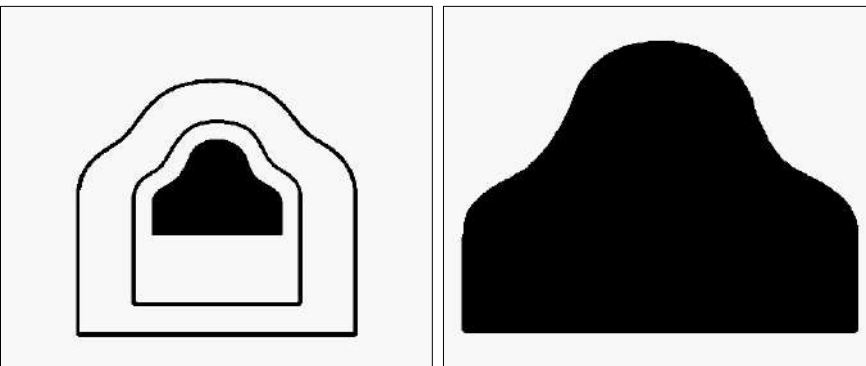

Zoom levels

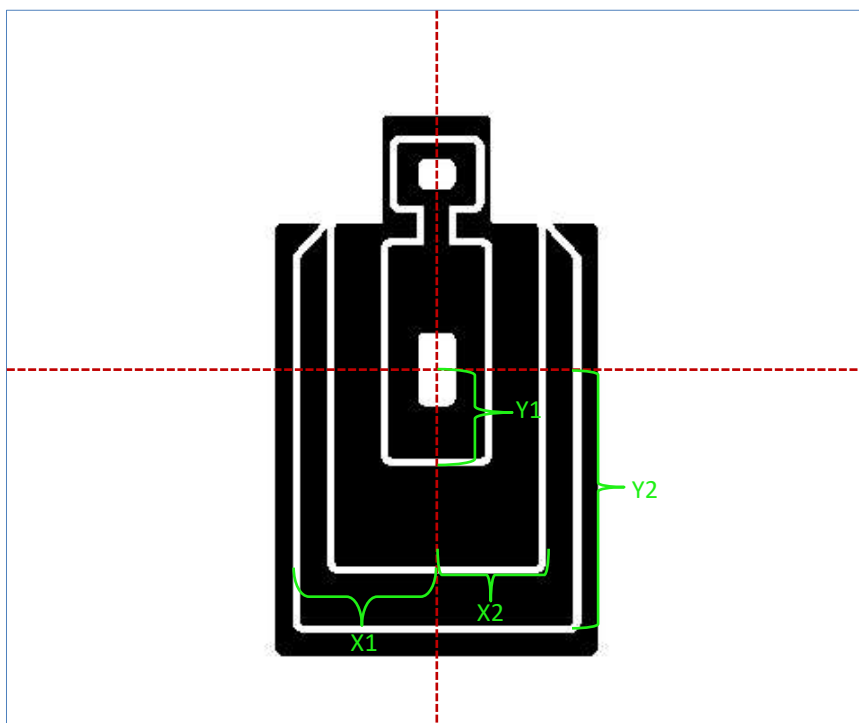

Technical data

Part No	735-0097-97-0445
Size	67 kb
Gauge (default)	5.56 mm
Aiming mark diameter	N/A
Manufacture	
Manufacture Part No	



Zone	Text	Value
	EDG	0
	D	0
	C	1
	B	2
	A	3
	AL	4
	AU	5

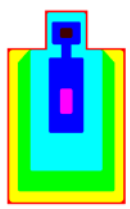

X1	200 mm	X2	77 mm
Y1	133 mm	Y2	284 mm

Zoom levels

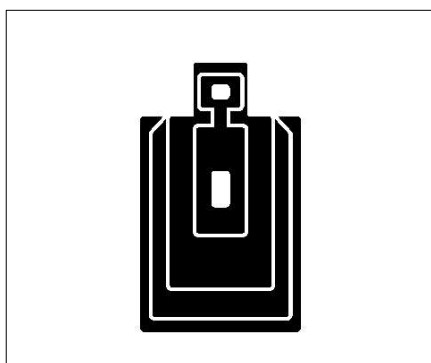

Technical data

Part No	735-0097-97-0447
Size	116 Kb
Gauge (default)	8 mm
Aiming mark diameter	
Manufacture	
Manufacture Part No	

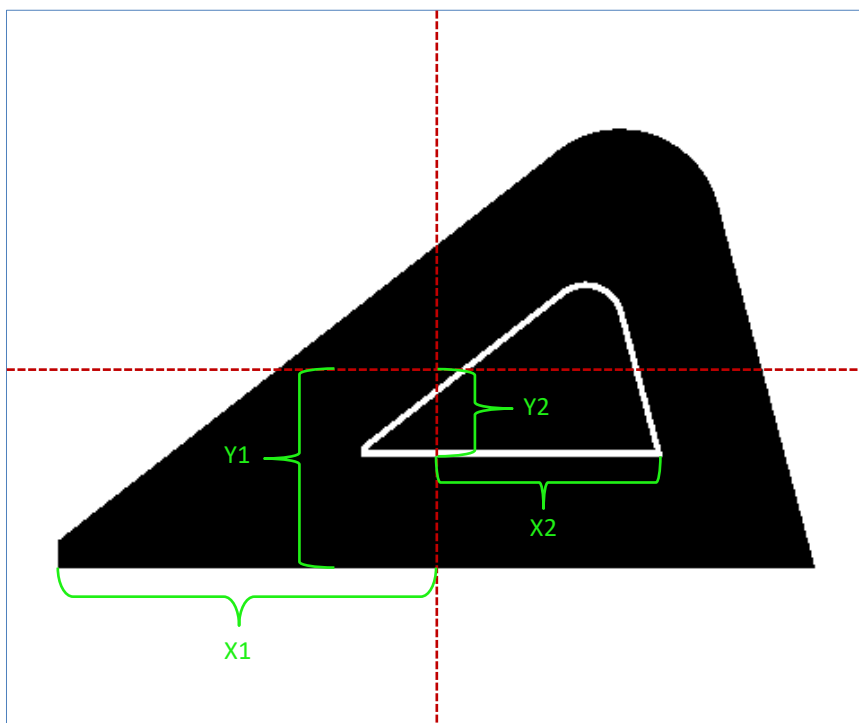

Zone	Text	Value
■	*	1
■	X	1
■	0	0

X1	95 mm	X2	57 mm
Y1	49,9 mm	Y2	22 mm



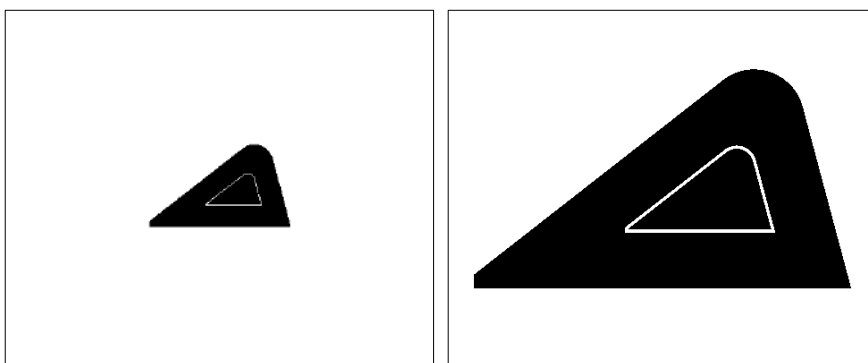

Zoom levels

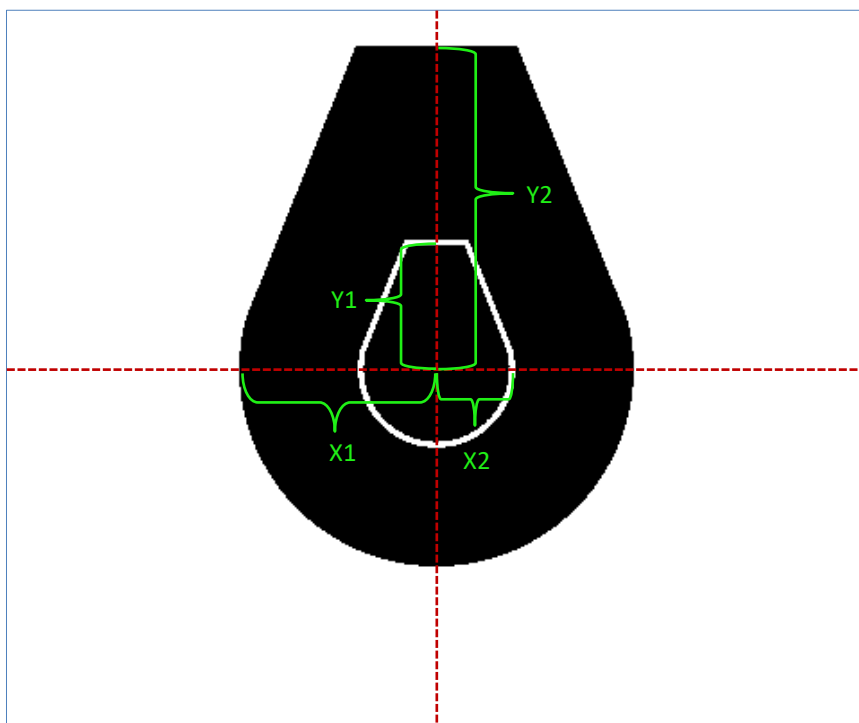

Technical data

Part No	735-0097-97-0448
Size	45 Kb
Gauge (default)	8 mm
Aiming mark diameter	
Manufacture	
Manufacture Part No	



Zone	Text	Value
	*	1
	X	1
	0	0
		

X1	55 mm	X2	22 mm
Y1	36 mm	Y2	90 mm

Zoom levels

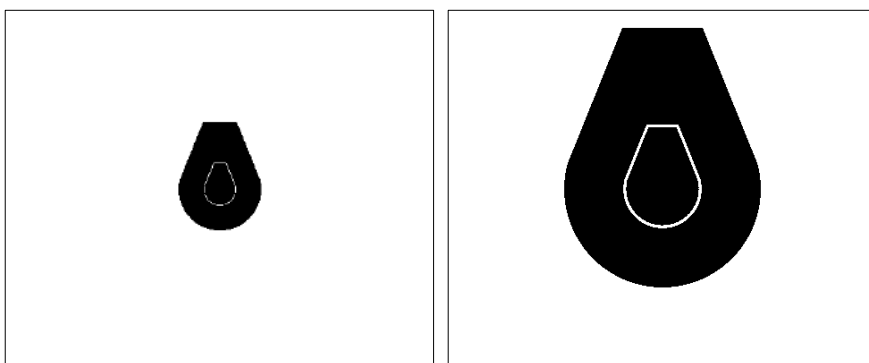

Technical data

Part No	735-0097-97-0449
Size	48 Kb
Gauge (default)	8 mm
Aiming mark diameter	
Manufacture	
Manufacture Part No	

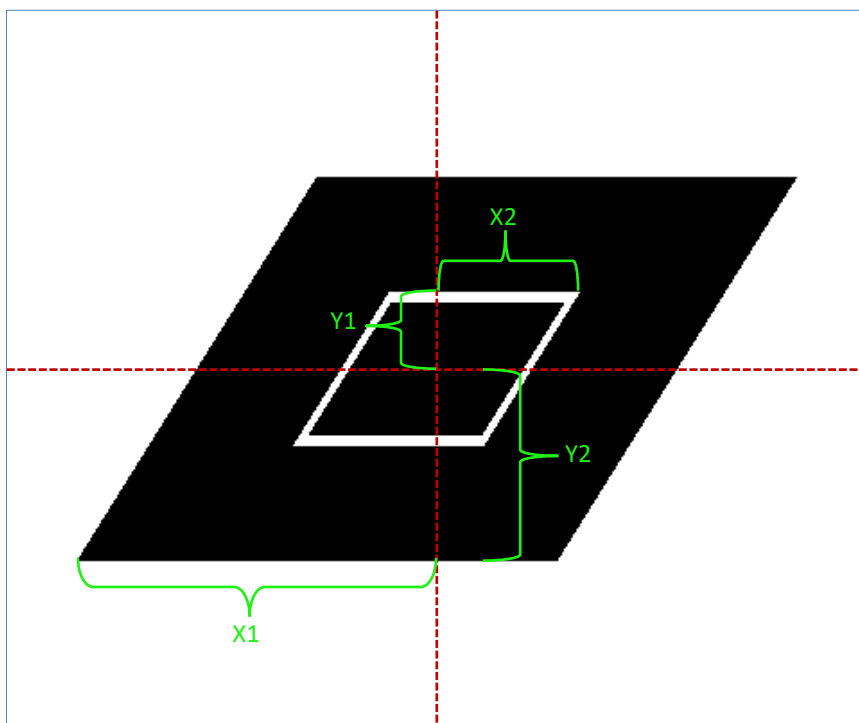

Zone	Text	Value
	*	1
	X	1
	0	0

X1	80 mm	X2	32 mm
Y1	17 mm	Y2	42,5 mm

Zoom levels

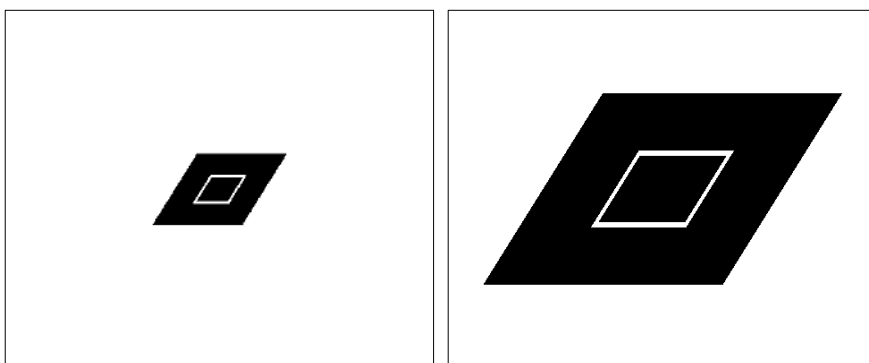

Technical data

Part No	735-0097-97-0450
Size	41 Kb
Gauge (default)	8 mm
Aiming mark diameter	
Manufacture	
Manufacture Part No	

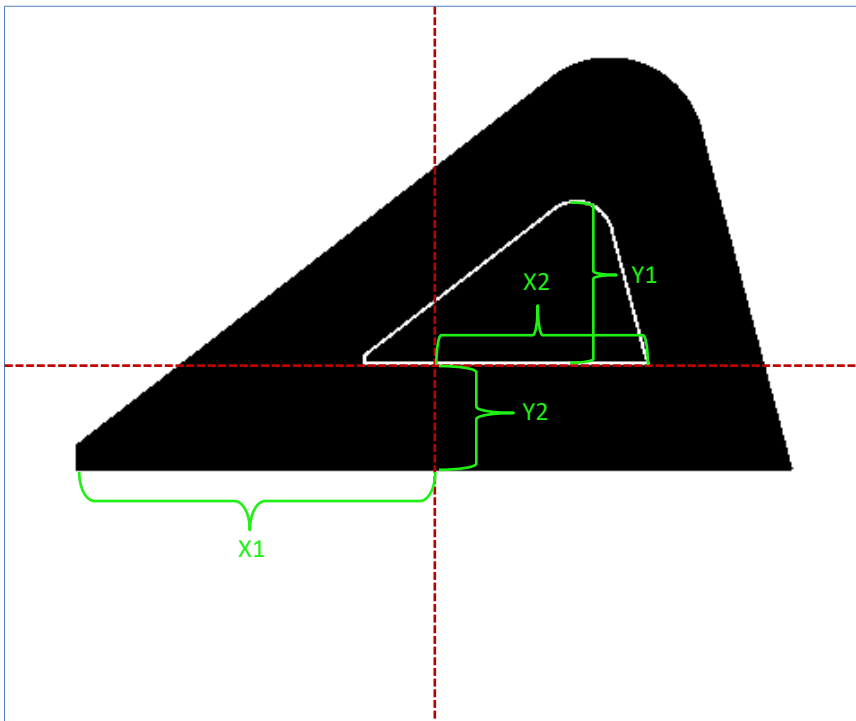

Zone	Text	Value
	*	1
	X	1
	0	0

X1	165 mm	X2	99 mm
Y1	76 mm	Y2	48,4 mm



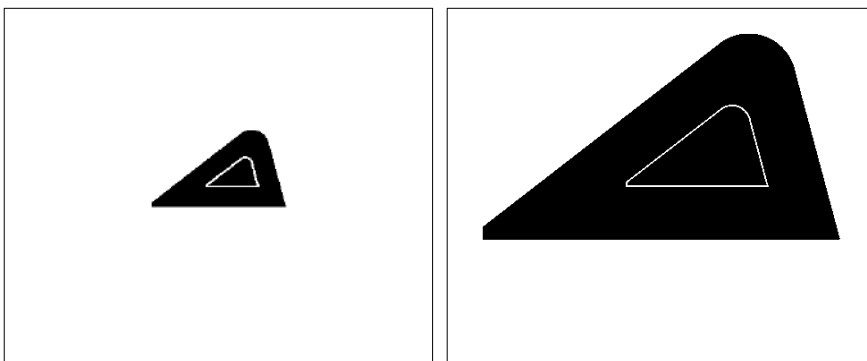

Zoom levels

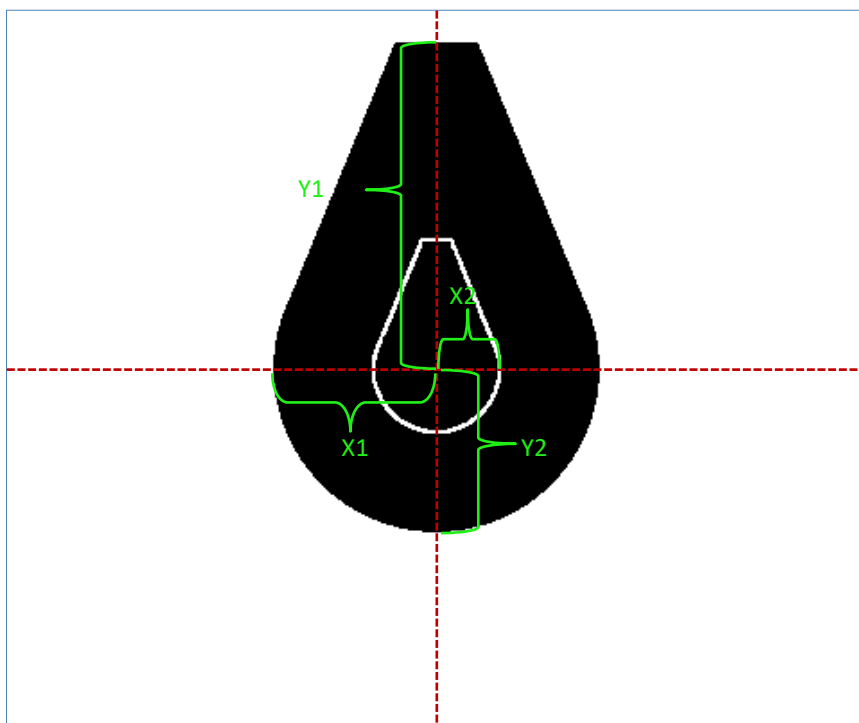

Technical data

Part No	735-0097-97-0451
Size	42 Kb
Gauge (default)	8 mm
Aiming mark diameter	
Manufacture	
Manufacture Part No	



Zone	Text	Value
	*	1
	X	1
	0	0
		

X1	100 mm	X2	40 mm
Y1	200 mm	Y2	100mm

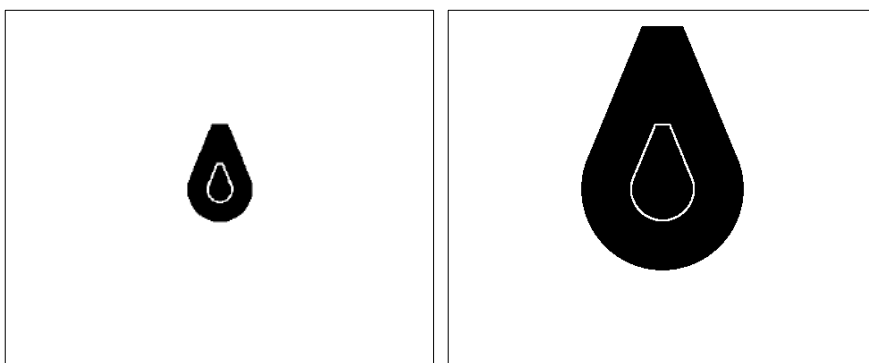

Zoom levels

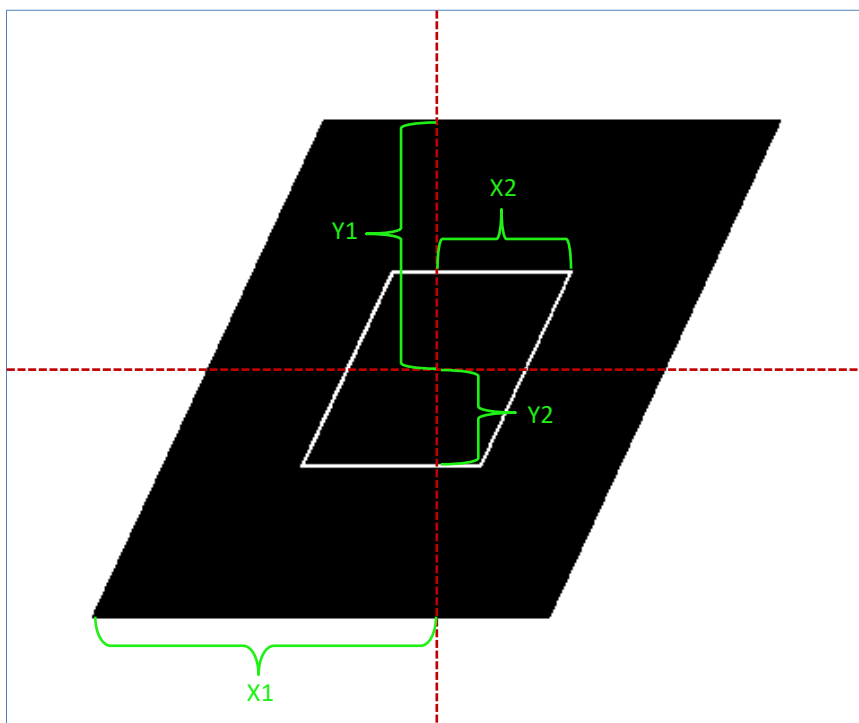

Technical data

Part No	735-0097-97-0452
Size	47 Kb
Gauge (default)	8 mm
Aiming mark diameter	
Manufacture	
Manufacture Part No	



Zone	Text	Value
	*	1
	X	1
	0	0



X1	125 mm	X2	50 mm
Y1	90 mm	Y2	36 mm

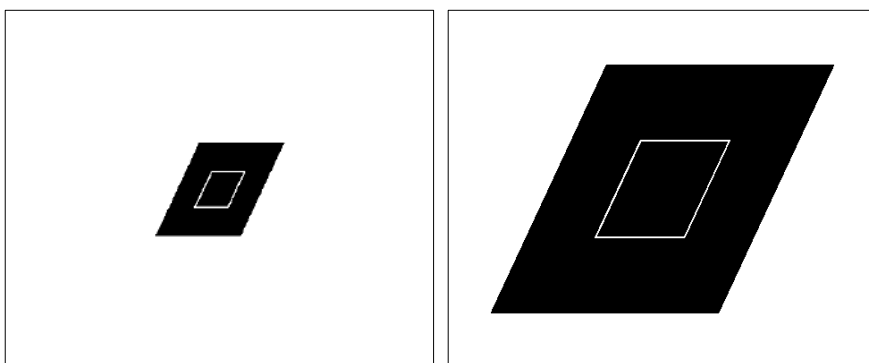

Zoom levels

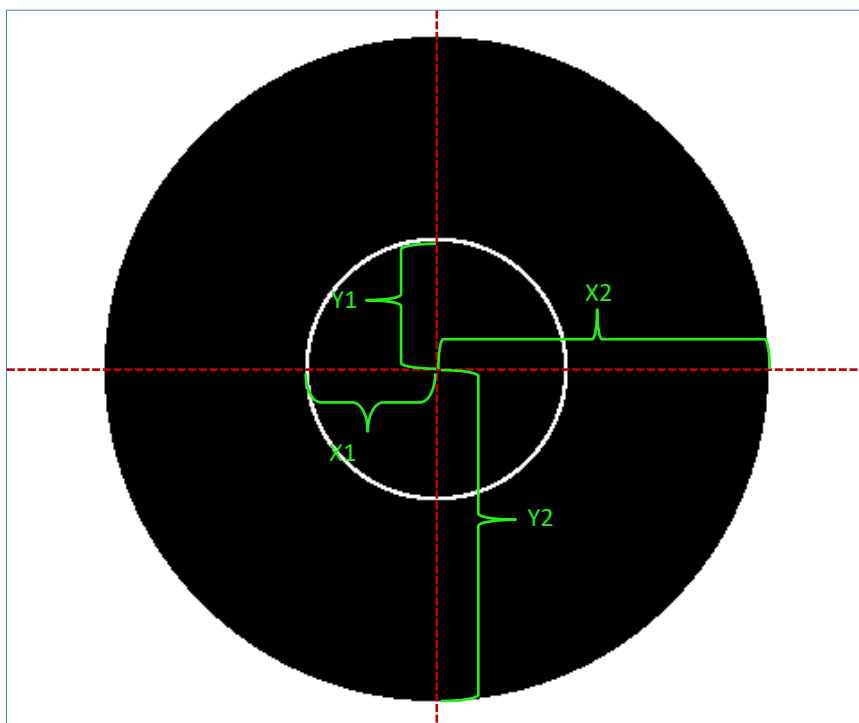

Technical data

Part No	735-0097-97-0453
Size	46 Kb
Gauge (default)	8 mm
Aiming mark diameter	
Manufacture	
Manufacture Part No	



Zone	Text	Value
	*	1
	X	1
	0	0



X1	48 mm	X2	120 mm
Y1	48 mm	Y2	120 mm

Zoom levels

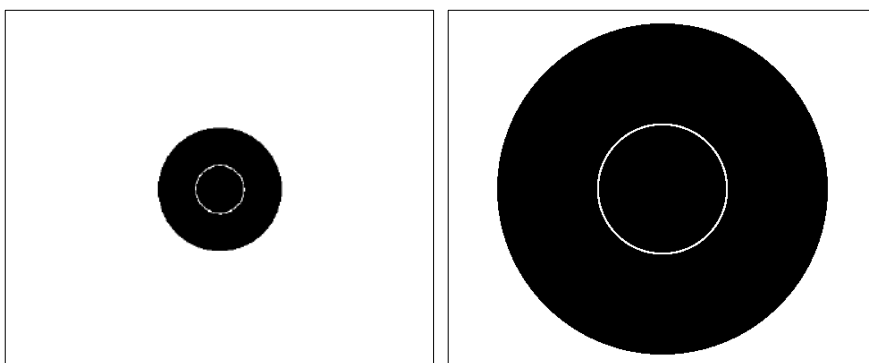

Technical data

Part No	735-0097-97-0454
Size	55 Kb
Gauge (default)	8 mm
Aiming mark diameter	
Manufacture	
Manufacture Part No	

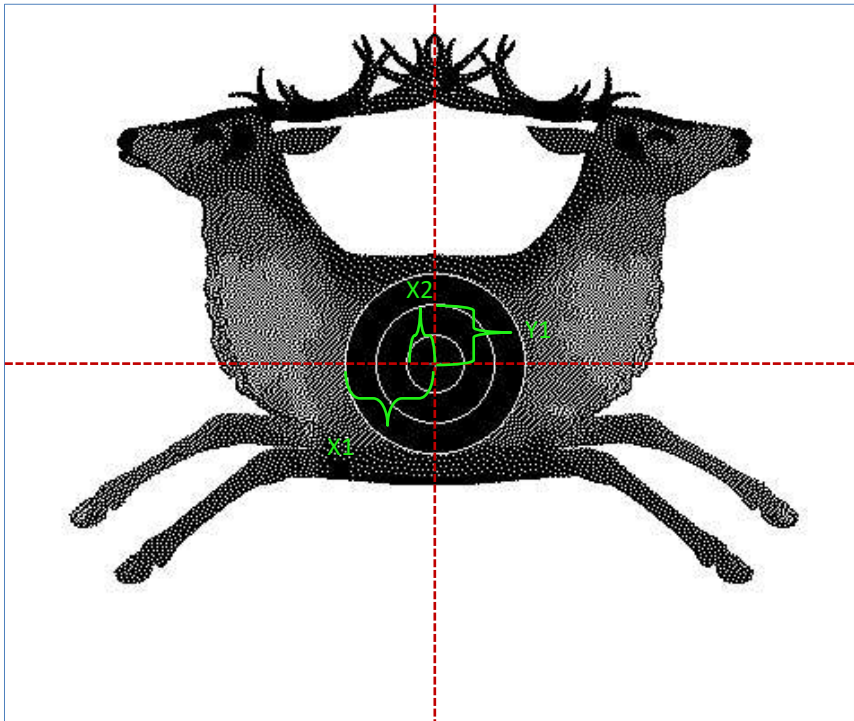

Zone/diameter	Text	Value
150 mm	5	5
300 mm	4	4
450 mm	3	3
	2	2



X1	225 mm	X2	75 mm
Y1	150 mm		

Zoom levels

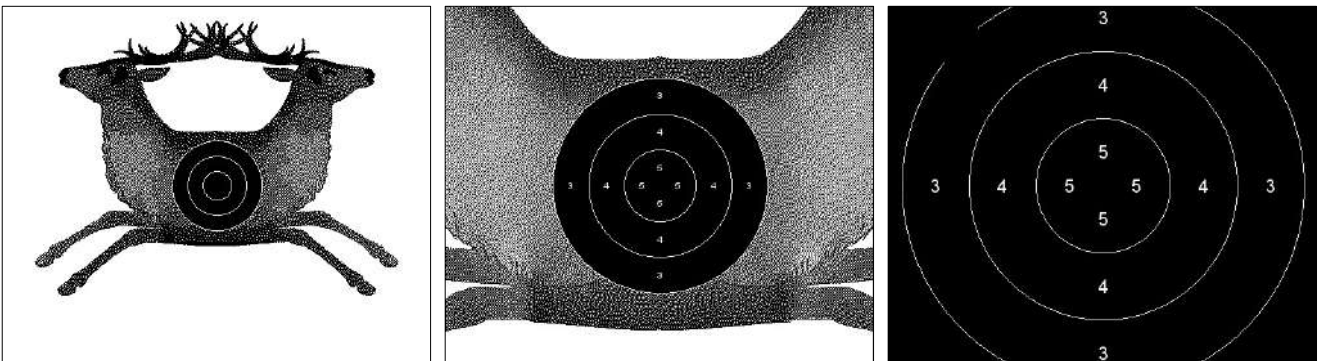

Technical data

Part No	735-0097-97-0458
Size	169 Kb
Gauge (default)	4.5 mm
Aiming mark diameter	
Manufacture	
Manufacture Part No	

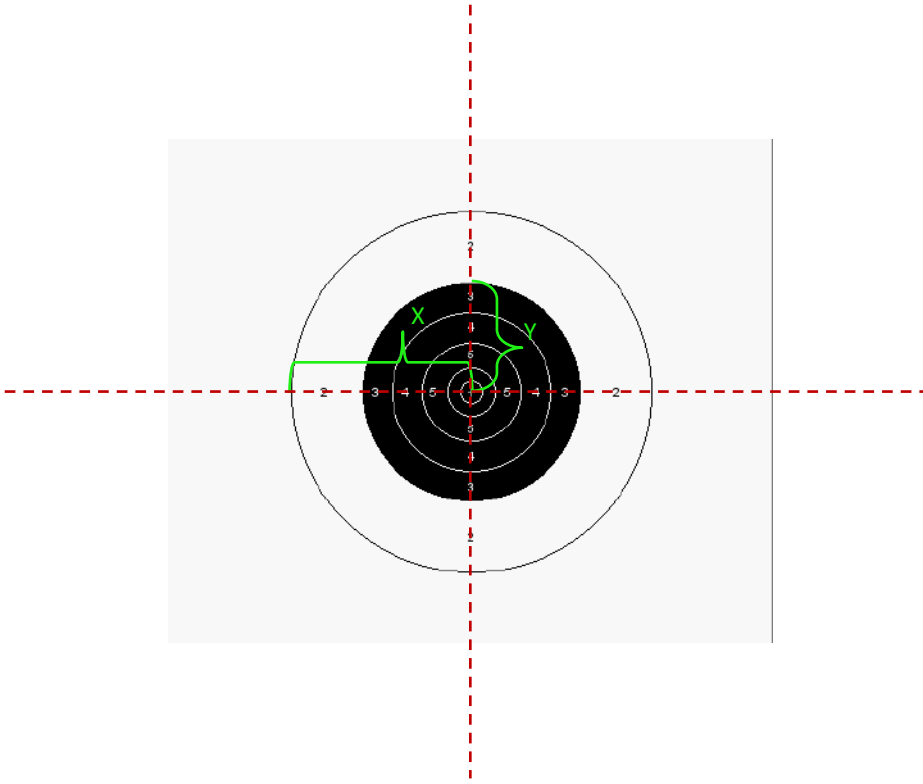

Diameter (mm)	Value
127	X
255	V
510	5
815	4
1120	3
1830	2
ROT 3070x1830	1

X	1830 mm
Y	1120 mm

Zoom levels

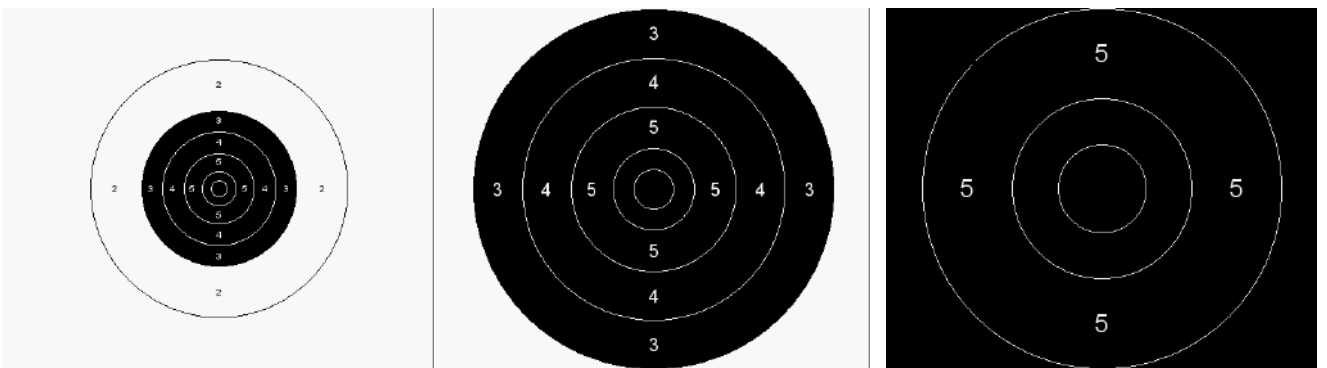

Technical data

Part No	735-0097-97-0459
Size	N/A
Gauge (default)	7,82 mm
Aiming mark diameter	1120 mm
Manufacture	
Manufacture Part No	

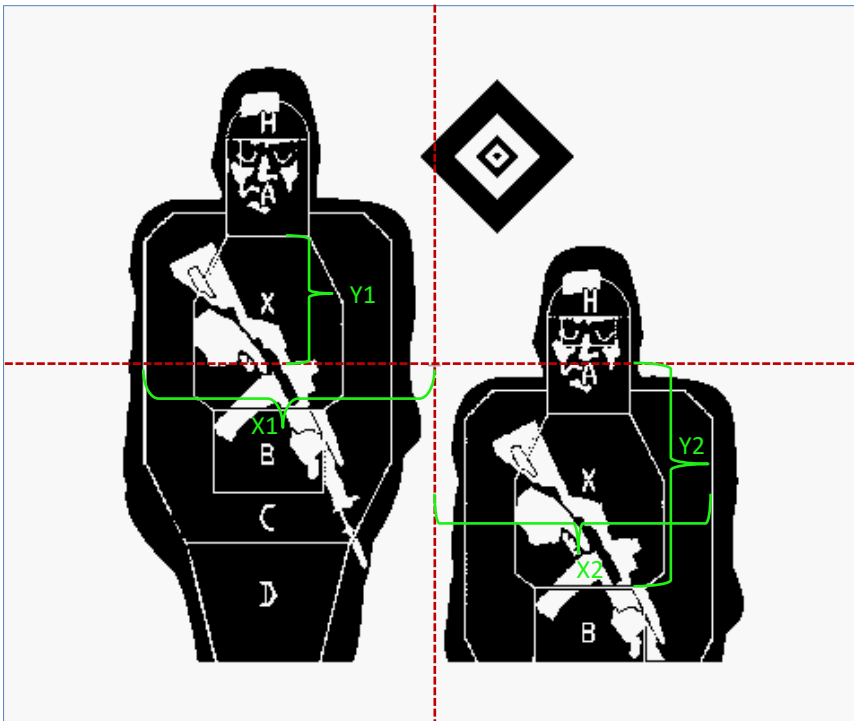

Zone	Text	Value
0	R	0
1	vD	1
2	vC	1
3	vB	1
4	vX	1
5	vA	1
6	vH	1
7	vAX	1
8	hC	1
9	hB	1
10	hX	1
11	hA	1
12	hH	1
13	hAX	1

X1	435.4 mm	X2	510 mm
Y1	232,3 mm	Y2	407,8 mm

Zoom levels

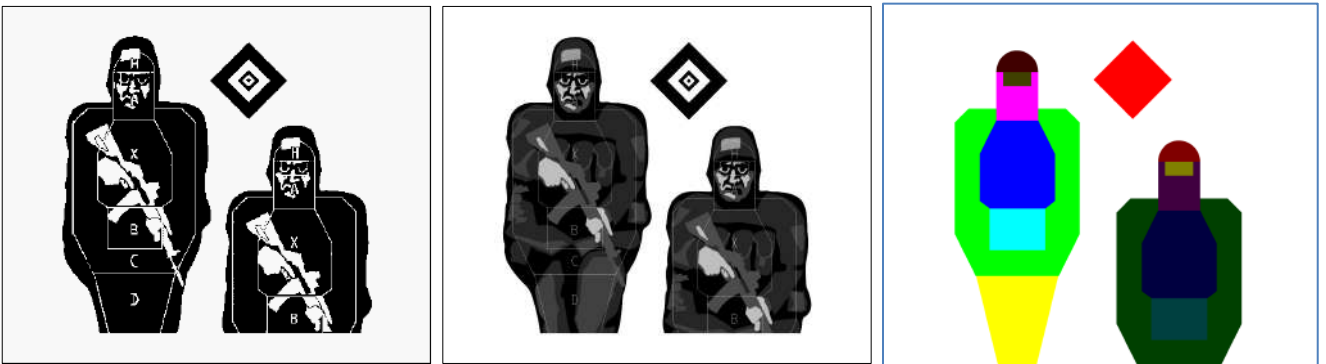

Technical data

Part No	735-0097-97-0460
Size	81 Kb
Gauge (default)	8 mm
Aiming mark diameter	
Manufacture	
Manufacture Part No	

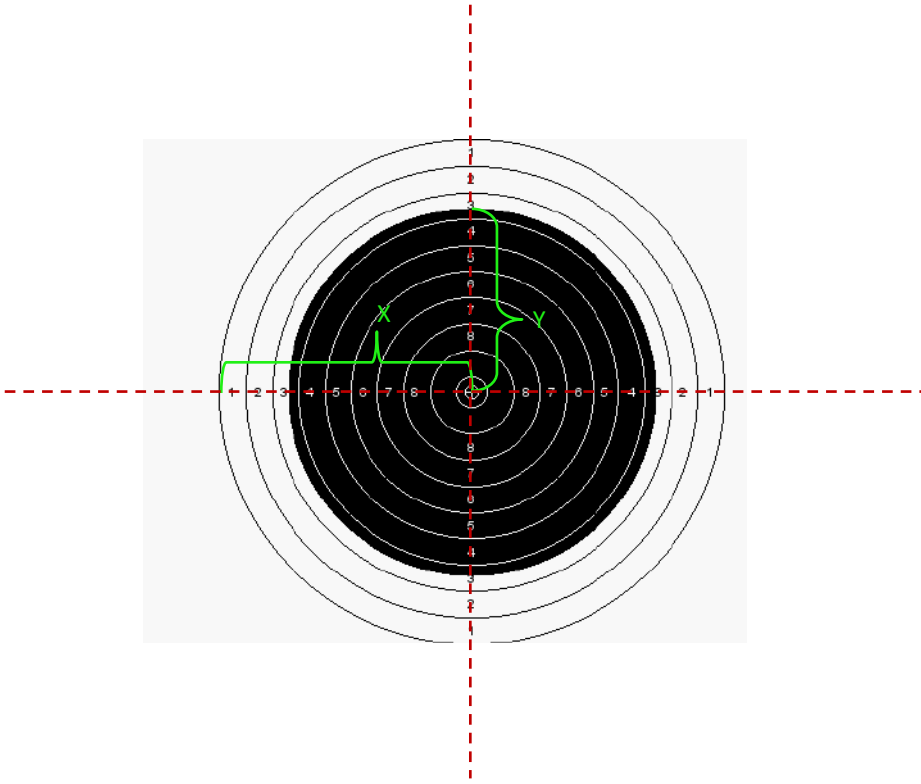

Diameter (mm)	Value
4,096	X
9,034	10
23,664	9
38,295	8
52,925	7
67,556	6
82,186	5
96,816	4
111,447	3
126,077	2
140,708	1

X	140,708 mm
Y	102,780 mm

Zoom levels

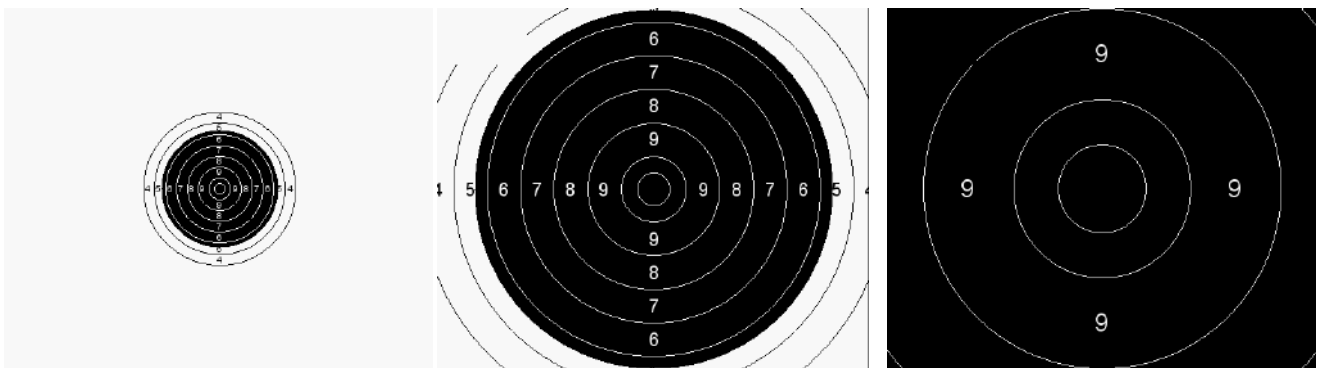

Technical data

Part No	735-0097-97-0461
Size	N/A
Gauge (default)	5,6 mm
Aiming mark diameter	102,780 mm
Manufacture	
Manufacture Part No	

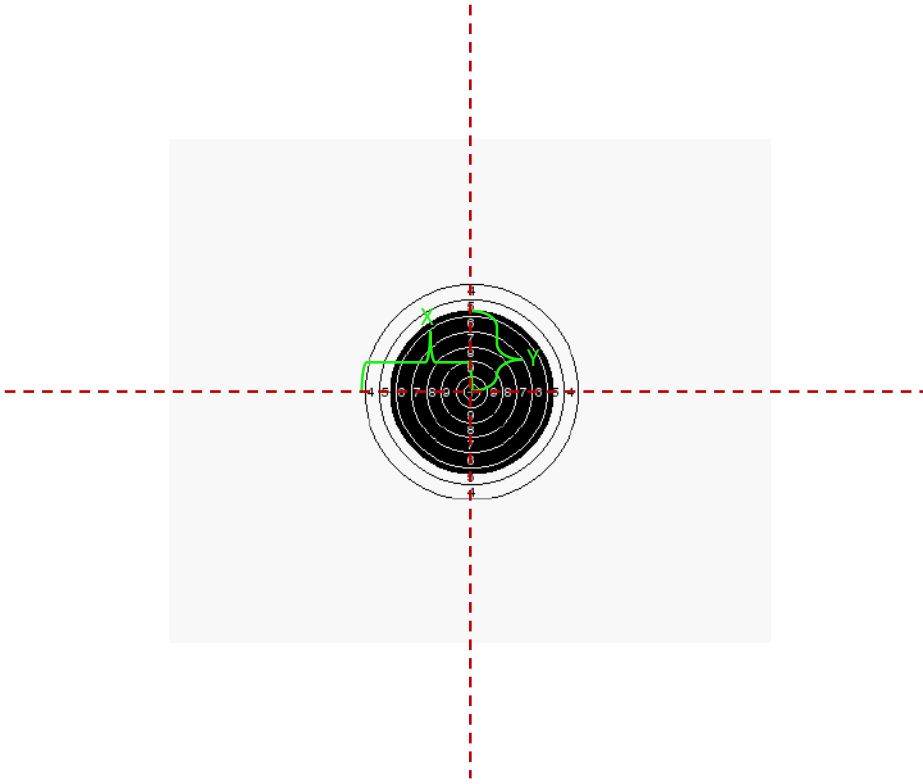

Diameter (mm)	Value
9,1186	X
18,2626	10
36,5506	9
54,8386	8
73,1266	7
91,4146	6
109,7026	5
127,9652	4

X	127,9652 mm
Y	98,806 mm

Zoom levels

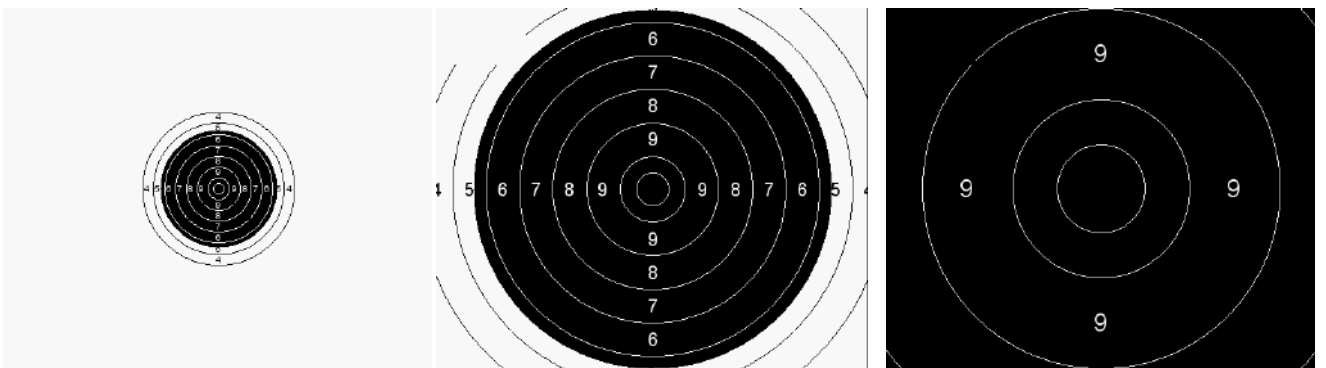

Technical data

Part No	735-0097-97-0462
Size	N/A
Gauge (default)	5,6 mm
Aiming mark diameter	98,806 mm
Manufacture	
Manufacture Part No	

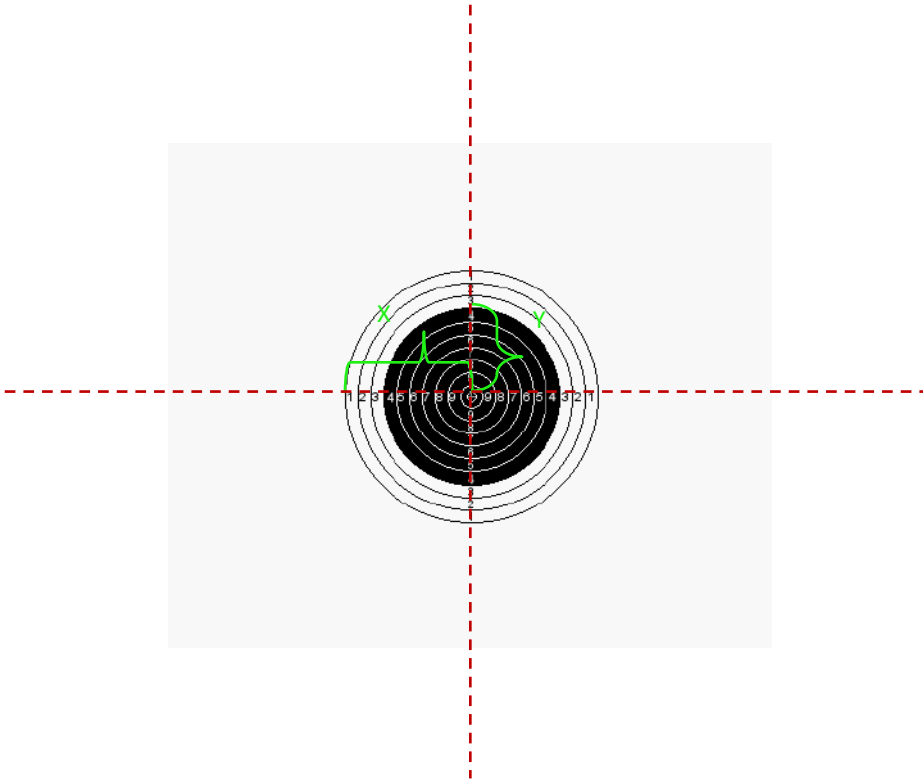

Diameter (mm)	Value
12,0904	X
27,3304	10
57,8104	9
88,2904	8
118,7704	7
149,2504	6
179,7304	5
210,2104	4
240,6904	3
271,1704	2
301,6504	1

X	140,708 mm
Y	210,2104 mm

Zoom levels

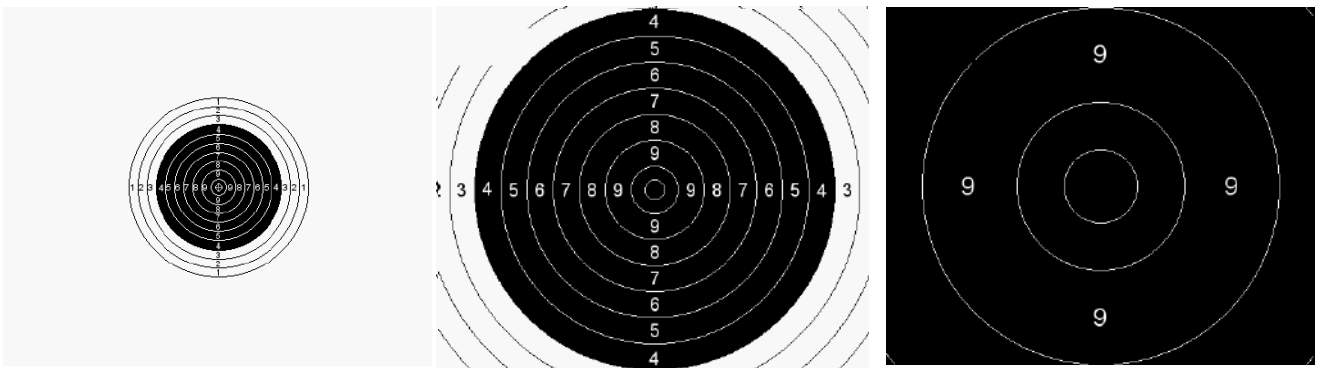

Technical data

Part No	735-0097-97-0463
Size	N/A
Gauge (default)	5,6 mm
Aiming mark diameter	210,2104 mm
Manufacture	
Manufacture Part No	

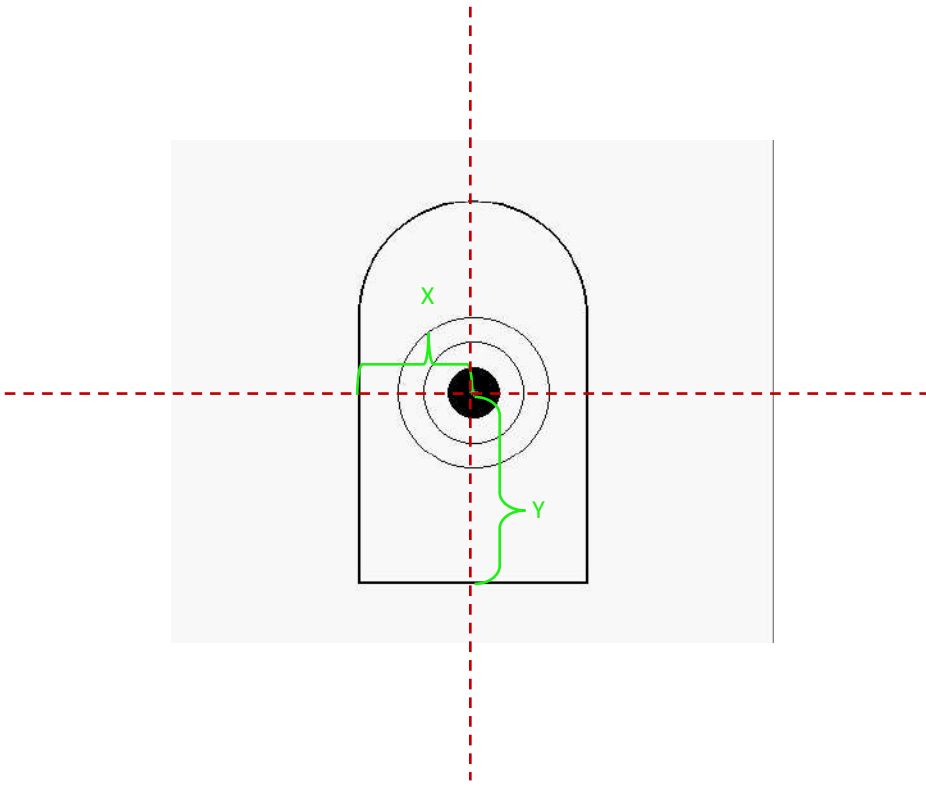

Diameter (mm)	Value
101.6	X
203.2	10
304.8	9
FIG	5
0	0

X	228.6 mm
Y	381 mm



Zoom levels

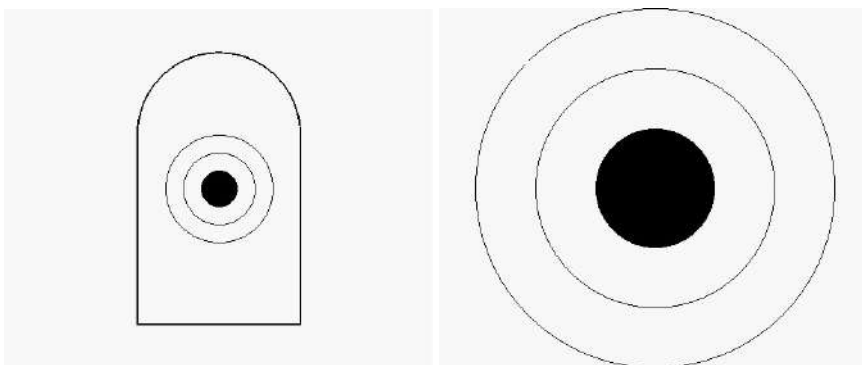

Technical data

Part No	735-0097-97-0464
Size	26 KB
Gauge (default)	9 mm
Aiming mark diameter	101.6mm
Manufacture	
Manufacture Part No	